

User's Guide

GS1350 Series

GbE Layer-2 PoE Switch

Default Login Details

Version 4.90 Edition 1, 02/2024

LAN IP Address	https://setup.zyxel or https://DHCP-assigned IP or https://192.168.1.1 or a configured static IP address
User Name	admin
Password	1234 (Standalone mode) or Local Credential Password (Cloud mode)

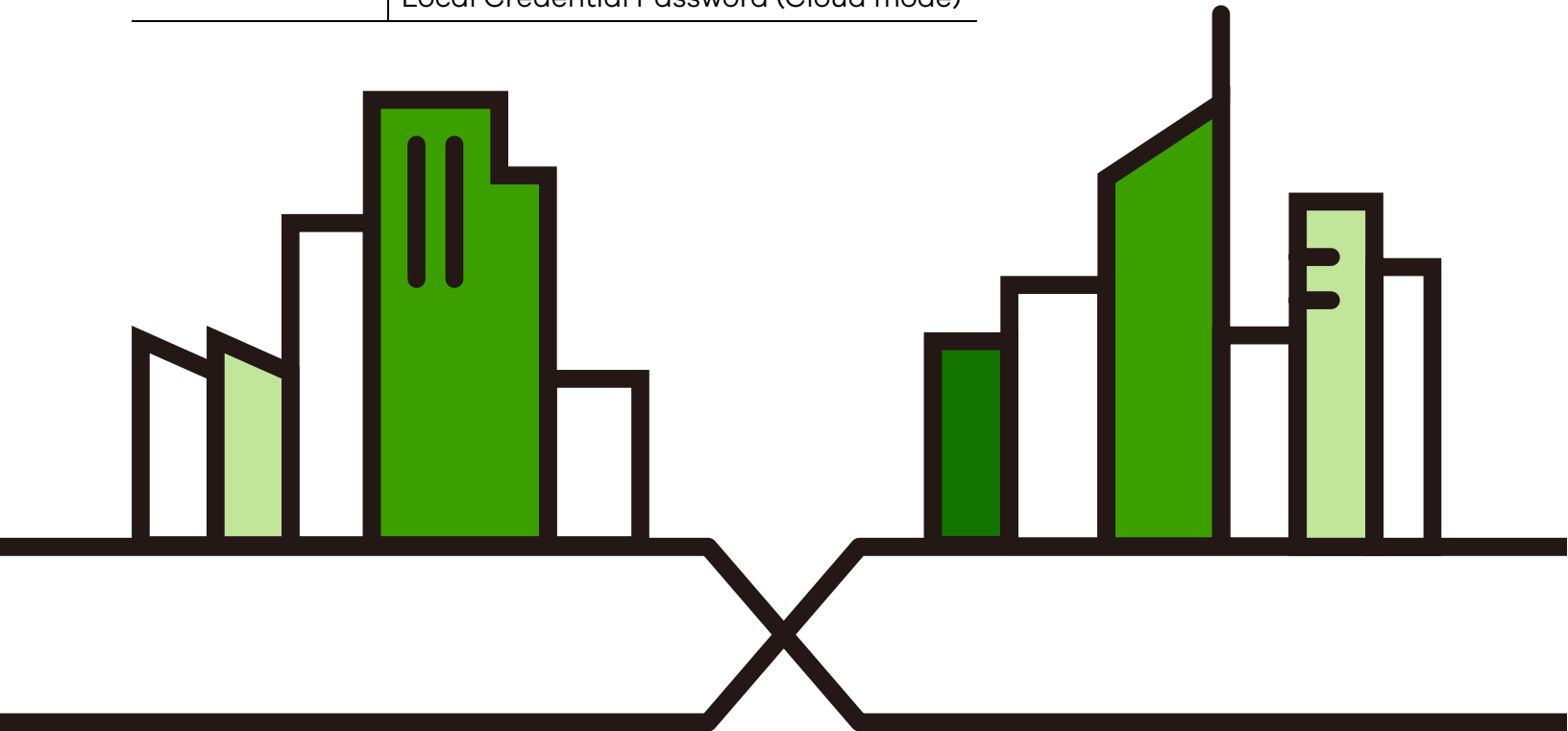

IMPORTANT!

READ CAREFULLY BEFORE USE.

KEEP THIS GUIDE FOR FUTURE REFERENCE.

This is a User's Guide for a series of products. Not all products support all firmware features. Screenshots and graphics in this book may differ slightly from your products due to differences in your product firmware or your computer operating system. Every effort has been made to ensure that the information in this manual is accurate.

Note: The version number on the cover page refers to the Switch's latest firmware version to which this User's Guide applies.

This is a User's Guide for a series of products. Not all products support all firmware features. Screenshots and graphics in this book may differ slightly from your product due to differences in your product firmware or your computer operating system. Every effort has been made to ensure that the information in this manual is accurate.

Related Documentation

- Quick Start Guide
The Quick Start Guide shows how to connect the Switch.
- Web Configurator Online Help
Click the help link for a description of the fields in the Switch menus.
- Nebula Control Center (NCC) User's Guide
Go to nebula.zyxel.com or support.zyxel.com to get this User's Guide on how to configure the Switch using Nebula.
- More Information
Go to support.zyxel.com to find other information on the Switch.



Document Conventions

Warnings and Notes

These are how warnings and notes are shown in this guide.

Warnings tell you about things that could harm you or your device.









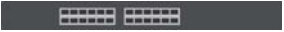

Note: Notes tell you other important information (for example, other things you may need to configure or helpful tips) or recommendations.

Syntax Conventions

- All models may be referred to as the "Switch" in this guide.
- Product labels, screen names, field labels and field choices are all in **bold** font.
- A right angle bracket (>) within a screen name denotes a mouse click. For example, **SYSTEM > IP Setup > Network Proxy Configuration** means you first click **SYSTEM** in the navigation panel, then the **IP Setup** sub menu, then **Network Proxy Configuration** to get to that screen.

Icons Used in Figures

Figures in this user guide may use the following generic icons. The Switch icon is not an exact representation of your device.

Switch 	Generic Router 	Wireless Router / Access Point 
Generic Switch 	Smart TV 	Desktop 
Laptop 	IP Camera 	Printer 
Server 		

Contents Overview

User's Guide	21
Getting to Know Your Switch	22
Hardware Installation and Connection	32
Hardware Panels	38
Technical Reference	49
Web Configurator	50
Initial Setup Example	81
Tutorials	86
DASHBOARD	90
MONITOR	95
ARP Table	96
IPv6 Neighbor Table	98
MAC Table	100
Neighbor	103
Path MTU Table	107
Port Status	108
System Information	115
System Log	117
SYSTEM	118
Cloud Management	119
General Setup	121
Interface Setup	124
IP Setup	126
IPv6	133
Logins	146
SNMP	148
Switch Setup	160
Syslog Setup	162
Time Range	165
PORT	168
Auto PD Recovery	169
Green Ethernet	174
Link Aggregation	176
Link Layer Discovery Protocol (LLDP)	184
PoE Setup	206
Port Setup	213
SWITCHING	215

Loop Guard	216
Mirroring	219
Multicast	221
Static Multicast Forwarding	228
ONVIF	231
Differentiated Services	233
Queuing Method	237
Priority Queue	240
Bandwidth Control	242
Spanning Tree Protocol	244
Static MAC Filtering	252
Static MAC Forwarding	254
VLAN	257
NETWORKING	276
ARP Setup	277
DHCP	281
SECURITY	294
AAA	295
Access Control	304
Storm Control	315
Error-Disable	317
DHCP Snooping	323
Port Security	335
MAINTENANCE	338
Surveillance Mode	367
Quick Setup	372
Monitor	373
System	375
Port	388
Switching	401
Security	409
Maintenance	415
Troubleshooting and Appendices	420
Troubleshooting	421

Table of Contents

Document Conventions	3
Contents Overview	4
Table of Contents	6
Part I: User's Guide	21
Chapter 1	
Getting to Know Your Switch	22
1.1 Introduction	22
1.1.1 Management Modes	22
1.1.2 Mode Changing	23
1.1.3 ZON Utility	26
1.1.4 Web Configurator Surveillance Mode	26
1.1.5 PoE	26
1.2 Example Applications	27
1.2.1 PoE Example Application	27
1.2.2 Backbone Example Application	28
1.2.3 Bridging or Fiber Optic Uplink Example Application	29
1.2.4 High Performance Switching Example	29
1.2.5 IEEE 802.1Q VLAN Application Examples	30
1.3 Ways to Manage the Switch	30
1.4 Good Habits for Managing the Switch	31
Chapter 2	
Hardware Installation and Connection	32
2.1 Installation Scenarios	32
2.2 Safety Precautions	32
2.3 Freestanding Installation Procedure	32
2.4 Wall Mount	33
2.4.1 Installation Requirements	33
2.5 Mount the Switch on a Rack	35
2.5.1 Installation Requirements	35
2.5.2 Precautions	36
2.5.3 Attach the Mounting Brackets to the Switch	36
2.5.4 Mount the Switch on a Rack	36

Chapter 3	
Hardware Panels.....	38
3.1 Front Panel Connections	38
3.1.1 Multi-Gigabit Ethernet Ports	39
3.1.2 PoE	40
3.1.3 SFP Slots	40
3.1.4 Dual Personality Interfaces	42
3.1.5 Console Port	42
3.2 Rear Panel	43
3.2.1 Grounding	43
3.2.2 AC Power Connection	45
3.2.3 Power Connection	45
3.3 LEDs	46
Part II: Technical Reference.....	49
Chapter 4	
Web Configurator.....	50
4.1 Overview	50
4.2 System Login	50
4.3 Zyxel One Network (ZON) Utility	56
4.3.1 Requirements	56
4.3.2 Run the ZON Utility	57
4.4 Wizard	60
4.4.1 Basic	61
4.4.2 Protection	65
4.4.3 VLAN	68
4.4.4 QoS	69
4.5 Web Configurator Layout	70
4.5.1 Tables and Lists	77
4.5.2 Change Your Password	78
4.6 Save Your Configuration	78
4.7 Switch Lockout	79
4.8 Reset the Switch	79
4.8.1 Restore Button	79
4.8.2 Restore Custom Default (Standalone mode only)	79
4.8.3 Reboot the Switch	80
4.9 Log Out of the Web Configurator	80
4.10 Help	80
Chapter 5	
Initial Setup Example	81

5.1 Overview	81
5.1.1 Create a VLAN	81
5.1.2 Set Port VID	82
5.1.3 Configure Switch Management IP Address	83
Chapter 6	
Tutorials	86
6.1 Overview	86
6.2 How to Use DHCPv4 Relay on the Switch	86
6.2.1 DHCP Relay Tutorial Introduction	86
6.2.2 Create a VLAN	86
6.2.3 Configure DHCPv4 Relay	88
6.2.4 Troubleshooting	89
Chapter 7	
DASHBOARD	90
7.1 New User Interface	90
7.2 DASHBOARD	90
7.2.1 Port Status	93
7.2.2 Quick Links to Use	94
Chapter 8	
MONITOR.....	95
Chapter 9	
ARP Table.....	96
9.1 ARP Table Overview	96
9.1.1 What You Can Do	96
9.1.2 What You Need to Know	96
9.2 Viewing the ARP Table	96
Chapter 10	
IPv6 Neighbor Table.....	98
10.1 IPv6 Neighbor Table Overview	98
10.2 Viewing the IPv6 Neighbor Table	98
Chapter 11	
MAC Table.....	100
11.1 MAC Table Overview	100
11.1.1 What You Can Do	100
11.1.2 What You Need to Know	100
11.2 Viewing the MAC Table	101

Chapter 12	
Neighbor	103
12.1 Neighbor Overview	103
12.1.1 What You Can Do	103
12.2 Neighbor	103
12.2.1 Neighbor Details	104
Chapter 13	
Path MTU Table	107
13.1 Path MTU Overview	107
13.2 Viewing the Path MTU Table	107
Chapter 14	
Port Status	108
14.0.1 What You Can Do	108
14.1 Port Status	108
14.1.1 Port Details	109
14.2 DDMI	112
14.2.1 DDMI Details	112
14.3 Port Utilization	114
Chapter 15	
System Information	115
15.0.1 What You Can Do	115
15.1 System Information	115
Chapter 16	
System Log	117
16.1 System Log Overview	117
16.2 System Log	117
Chapter 17	
SYSTEM	118
Chapter 18	
Cloud Management	119
18.1 Cloud Management Overview	119
18.2 Nebula Center Control Discovery	119
Chapter 19	
General Setup	121
19.1 General Setup	121

Chapter 20	
Interface Setup	124
20.1 Interface Setup Overview	124
20.2 Interface Setup	124
20.2.1 Add/Edit Interfaces	125
Chapter 21	
IP Setup	126
21.1 IP Setup Overview	126
21.1.1 What You Can Do	126
21.1.2 IP Interfaces	126
21.2 <i>IP Status</i>	127
21.2.1 IP Status Details	127
21.3 IP Setup	129
21.3.1 Add/Edit IP Interfaces	131
21.4 Network Proxy Configuration	131
Chapter 22	
IPv6	133
22.1 IPv6 Overview	133
22.2 IPv6 Status	133
22.2.1 IPv6 Interface Status Details	134
22.3 IPv6 Global Setup	136
22.4 IPv6 Interface Setup	137
22.4.1 Edit an IPv6 Interface	137
22.5 IPv6 Link-Local Address Setup	138
22.5.1 Edit an IPv6 Link-Local Address	138
22.6 IPv6 Global Address Setup	139
22.6.1 Add/Edit an IPv6 Global Address	140
22.7 IPv6 Neighbor Discovery Setup	141
22.7.1 Edit an IPv6 Neighbor Discovery	141
22.8 IPv6 Neighbor Setup	142
22.8.1 Add/Edit IPv6 Neighbor	143
22.9 DHCPv6 Client Setup	144
22.9.1 Edit DHCPv6 Client	144
Chapter 23	
Logins	146
23.1 Set Up Login Accounts	146
Chapter 24	
SNMP	148
24.1 SNMP Overview	148

24.1.1 What You Can Do	148
24.2 Configure SNMP	148
24.3 Configure SNMP User	150
24.3.1 Add/Edit SNMP User	150
24.4 SNMP Trap Group	152
24.5 Enable or Disable Sending of SNMP Traps on a Port	153
24.6 Technical Reference	153
24.6.1 About SNMP	154
Chapter 25	
Switch Setup	160
25.1 Switch Setup Overview	160
25.1.1 Introduction to VLANs	160
25.2 Switch Setup	160
Chapter 26	
Syslog Setup	162
26.1 Syslog Overview	162
26.1.1 What You Can Do	162
26.2 Syslog Setup	162
26.2.1 Add/Edit a Syslog Server	164
Chapter 27	
Time Range.....	165
27.1 Time Range Overview	165
27.1.1 What You Can Do	165
27.2 Configure a Time Range	165
27.2.1 Add/Edit Time Range	166
Chapter 28	
PORT	168
Chapter 29	
Auto PD Recovery.....	169
29.1 Auto PD Recovery (for PoE models only) Overview	169
29.1.1 What You Can Do	169
29.2 Auto PD Recovery	169
29.2.1 Activate the Automatic PD Recovery	171
Chapter 30	
Green Ethernet	174
30.1 Green Ethernet Overview	174
30.2 Configure Green Ethernet	174

Chapter 31	
Link Aggregation	176
31.1 Link Aggregation Overview	176
31.1.1 What You Can Do	176
31.1.2 What You Need to Know	176
31.2 Link Aggregation Status	177
31.3 Link Aggregation Setting	179
31.4 Link Aggregation Control Protocol	180
31.5 Technical Reference	182
31.5.1 Static Trunking Example	182
Chapter 32	
Link Layer Discovery Protocol (LLDP)	184
32.1 LLDP Overview	184
32.2 LLDP-MED Overview	185
32.2.1 What You Can Do – LLDP	186
32.2.2 What You Can Do – LLDP MED	186
32.3 LLDP Local Status	186
32.3.1 LLDP Local Port Status Details	188
32.4 LLDP Remote Status	191
32.4.1 LLDP Remote Port Status Details	191
32.5 LLDP Setup	196
32.6 Basic TLV Setting	198
32.7 Org-specific TLV Setting	199
32.8 LLDP-MED Setup	200
32.9 LLDP-MED Network Policy	201
32.9.1 Add/Edit LLDP-MED Network Policy	201
32.10 LLDP-MED Location	202
32.10.1 Add/Edit LLDP-MED Location	203
Chapter 33	
PoE Setup	206
33.1 PoE Status (for PoE models only)	206
33.2 PoE Setup	208
33.3 PoE Time Range Setup	211
33.3.1 Add/Edit PoE Time Range	211
Chapter 34	
Port Setup	213
34.1 Port Setup	213
Chapter 35	
SWITCHING	215

Chapter 36	
Loop Guard	216
36.1 Loop Guard Overview	216
36.1.1 What You Can Do	216
36.1.2 What You Need to Know	216
36.2 Loop Guard Setup	218
Chapter 37	
Mirroring.....	219
37.1 Mirroring Overview	219
37.2 Port Mirroring Setup	219
Chapter 38	
Multicast.....	221
38.1 Multicast Overview	221
38.1.1 What You Can Do – IPv4 Multicast	221
38.1.2 What You Need to Know	221
38.2 IPv4 Multicast Status	222
38.3 IGMP Snooping	223
38.4 IGMP Snooping VLAN	225
38.4.1 Add/Edit IGMP Snooping VLANs	226
Chapter 39	
Static Multicast Forwarding.....	228
39.1 Static Multicast Forwarding Overview	228
39.1.1 What You Can Do	228
39.1.2 What You Need To Know	228
39.2 Static Multicast Forwarding By MAC	229
39.2.1 Add/Edit Static Multicast Forwarding By MAC	230
Chapter 40	
ONVIF	231
40.1 ONVIF Overview	231
40.1.1 What You Can Do	231
40.2 ONVIF	231
40.3 Add/Edit ONVIF Protocol	232
Chapter 41	
Differentiated Services	233
41.1 DiffServ Overview	233
41.1.1 What You Can Do	233
41.1.2 What You Need to Know	233
41.2 Activate DiffServ	234

41.3 DSCP-to-IEEE 802.1p Priority Settings	235
41.3.1 Configure DSCP Settings	236
Chapter 42	
Queuing Method.....	237
42.1 Queuing Method Overview	237
42.1.1 What You Can Do	237
42.1.2 What You Need to Know	237
42.2 Configure Queuing	238
Chapter 43	
Priority Queue.....	240
43.1 Priority Queue Overview	240
43.1.1 What You Can Do	240
43.2 Assign Priority Queue	240
Chapter 44	
Bandwidth Control	242
44.1 Bandwidth Control Overview	242
44.1.1 What You Can Do	242
44.2 Bandwidth Control Setup	242
Chapter 45	
Spanning Tree Protocol	244
45.1 Spanning Tree Protocol Overview	244
45.1.1 What You Can Do	244
45.1.2 What You Need to Know	244
45.2 Spanning Tree Protocol Status	246
45.3 Spanning Tree Setup	246
45.4 Rapid Spanning Tree Protocol Status	248
45.5 Configure Rapid Spanning Tree Protocol	250
Chapter 46	
Static MAC Filtering.....	252
46.1 Static MAC Filtering Overview	252
46.1.1 What You Can Do	252
46.2 Configure a Static MAC Filtering Rule	252
46.2.1 Add/Edit a Static MAC Filtering Rule	253
Chapter 47	
Static MAC Forwarding.....	254
47.1 Static MAC Forwarding Overview	254
47.1.1 What You Can Do	254

47.2 Configure Static MAC Forwarding	254
47.2.1 Add/Edit Static MAC Forwarding Rules	255
Chapter 48	
VLAN.....	257
48.1 VLAN Overview	257
48.1.1 What You Can Do	257
48.1.2 What You Need to Know	257
48.2 Introduction to IEEE 802.1Q Tagged VLANs	257
48.3 VLAN Status	260
48.3.1 VLAN Details	261
48.4 Configure a Static VLAN	262
48.4.1 Add/Edit a Static VLAN	263
48.5 VLAN Port Setup	264
48.6 Voice VLAN	266
48.6.1 Add/Edit a Voice VLAN	267
48.7 MAC Based VLAN	268
48.7.1 Add/Edit a MAC Based VLAN	269
48.8 Vendor ID Based VLAN	269
48.8.1 Add/Edit a Vendor ID Based VLAN	270
48.9 Port-Based VLAN Setup	271
48.10 Configure a Port-Based VLAN	272
Chapter 49	
NETWORKING.....	276
Chapter 50	
ARP Setup.....	277
50.1 ARP Overview	277
50.1.1 What You Can Do	277
50.1.2 What You Need to Know	277
50.2 ARP Learning	279
Chapter 51	
DHCP	281
51.1 DHCP Overview	281
51.1.1 What You Can Do	281
51.1.2 What You Need to Know	281
51.2 DHCPv4 Relay Status	282
51.3 DHCPv4 Relay	282
51.3.1 DHCPv4 Relay Agent Information	282
51.4 DHCPv4 Option 82 Profile	283
51.4.1 Add/Edit a DHCPv4 Option 82 Profile	284
51.5 Configure a DHCPv4 Smart Relay	285

51.5.1 Add/Edit DHCPv4 Global Relay Port	286
51.5.2 DHCP Smart Relay Configuration Example	287
51.6 DHCPv4 VLAN Setting	289
51.6.1 Add/Edit DHCPv4 VLAN Setting	289
51.6.2 Add/Edit DHCPv4 VLAN Port	290
51.6.3 Example: DHCP Relay for Two VLANs	291
51.7 DHCPv6 Relay	292
51.7.1 Add/Edit DHCPv6 Relay	293
Chapter 52	
SECURITY	294
Chapter 53	
AAA	295
53.1 Authentication, Authorization and Accounting (AAA)	295
53.1.1 What You Can Do	295
53.1.2 What You Need to Know	295
53.2 RADIUS Server Setup	296
53.3 AAA Setup	298
53.4 Technical Reference	301
53.4.1 Vendor Specific Attribute	301
53.4.2 Supported RADIUS Attributes	302
53.4.3 Attributes Used for Authentication	303
Chapter 54	
Access Control.....	304
54.1 Access Control Overview	304
54.1.1 What You Can Do	304
54.2 Service Access Control	304
54.3 Remote Management (IPv4)	306
54.4 Remote Management (IPv6)	307
54.5 Account Security	308
54.6 Technical Reference	310
54.6.1 SSH Overview	310
54.6.2 Introduction to HTTPS	311
54.6.3 Google Chrome Warning Messages	313
Chapter 55	
Storm Control.....	315
55.1 Storm Control Overview	315
55.1.1 What You Can Do	315
55.2 Storm Control Setup	315

Chapter 56	
Error-Disable	317
56.1 Error-Disable Overview	317
56.1.1 CPU Protection Overview	317
56.1.2 Error-Disable Recovery Overview	317
56.1.3 What You Can Do	317
56.2 Error-Disable Status	318
56.3 CPU Protection Setup	319
56.4 Error-Disable Detect Setup	320
56.5 Error-Disable Recovery Setup	321
Chapter 57	
DHCP Snooping	323
57.1 DHCP Snooping Overview	323
57.1.1 What You Can Do	324
57.2 DHCP Snooping Status	324
57.3 DHCP Snooping Setup	327
57.4 DHCP Snooping Port Setup	328
57.5 DHCP Snooping VLAN Setup	330
57.6 DHCP Snooping VLAN Port Setup	331
57.6.1 Add/EDIT DHCP Snooping VLAN Ports	331
57.7 Technical Reference	332
57.7.1 DHCP Snooping Overview	332
Chapter 58	
Port Security	335
58.1 Port Security Overview	335
58.2 About Port Security	335
58.3 Port Security Setup	335
Chapter 59	
MAINTENANCE	338
59.1 Overview	338
59.1.1 What You Can Do	338
59.2 Certificates	338
59.2.1 Install Certificates	339
59.2.2 HTTPS Certificates	340
59.3 Technical Reference	340
59.3.1 FTP Command Line	340
59.3.2 Filename Conventions	340
59.3.3 FTP Command Line Procedure	341
59.3.4 GUI-based FTP Clients	342
59.3.5 FTP Restrictions	342

59.4 Cluster Management Overview	342
59.4.1 What You Can Do	343
59.5 Cluster Management Status	343
59.6 Clustering Management Setup	344
59.7 Technical Reference	346
59.7.1 Cluster Member Switch Management	346
59.8 Restore Configuration	348
59.9 Backup Configuration	348
59.10 Erase Running-Configuration	349
59.11 Save Configuration	350
59.12 Configure Clone	350
59.13 Diagnostic	352
59.14 Firmware Upgrade	355
59.15 Reboot System	356
59.16 SSH Authorized Keys	357
59.16.1 Generate the SSH Authorized Keys	358
59.17 Tech-Support	364
59.17.1 Tech-Support Download	366
Chapter 60	
Surveillance Mode.....	367
60.1 Overview	367
60.1.1 What You Can Do	367
60.2 Summary	367
60.3 Neighbor Detail Screen	369
Chapter 61	
Quick Setup.....	372
61.1 Quick Setup Screen	372
Chapter 62	
Monitor	373
62.1 What You Can Do	373
62.2 System Information	373
Chapter 63	
System.....	375
63.1 What You Can Do	375
63.2 Cloud Management	375
63.3 General Setup	377
63.4 IP Setup	378
63.5 Set Up Login Accounts	380
63.6 Configure SNMP	381

63.7 Configure SNMP User	383
63.8 Configure SNMP Trap Group	385
63.9 Enable or Disable Sending of SNMP Traps on a Port	386
Chapter 64	
Port	388
64.1 What You Can Do	388
64.2 Auto PD Recovery	388
64.3 Link Aggregation	390
64.4 Link Aggregation Status	390
64.5 Link Aggregation Setting	392
64.6 Link Aggregation Control Protocol	393
64.7 PoE Status	395
64.8 PoE Setup	397
64.9 Port Setup	399
Chapter 65	
Switching.....	401
65.1 Loop Guard	401
65.2 ONVIF	402
65.3 VLAN	403
65.3.1 What You Can Do	403
65.4 VLAN Status	403
65.4.1 VLAN Detail	404
65.5 Static VLAN	405
65.6 VLAN Port Setup	407
Chapter 66	
Security	409
66.1 Access Control	409
66.1.1 What You Can Do	409
66.2 Service Access Control Screen	409
66.3 Remote Management (IPv4)	410
66.4 Remote Management (IPv6)	412
66.5 Storm Control Overview	413
66.5.1 What You Can Do	413
66.6 Storm Control Setup	413
Chapter 67	
Maintenance.....	415
67.1 What You Can Do	415
67.2 Restore Configuration	415
67.3 Backup Configuration	416

67.4 Save Configuration 416
67.5 Firmware Upgrade 417
67.6 Reboot System 418
67.7 Tech-Support 419

Part III: Troubleshooting and Appendices 420

Chapter 68
Troubleshooting.....421

68.1 Power, Hardware Connections, and LEDs 421
68.2 Switch Access and Login 422
68.3 Switch Configuration 424
68.4 PoE Supply 426
68.5 Nebula Registration 426

Appendix A Customer Support 428
Appendix B Common Services 433
Appendix C IPv6..... 436
Appendix D Importing a Certificate 444
Appendix E Legal Information 457
Index462

PART I

User's Guide

CHAPTER 1

Getting to Know Your Switch

1.1 Introduction

This chapter introduces the main features and applications of the Switch.

The GS1350 Series consists of the following models:

- GS1350-6HP
- GS1350-12HP
- GS1350-18HP
- GS1350-26HP

All models are referred to as the “Switch” in this guide.

The following table describes the hardware features of the Switch by model.

Table 1 GS1350 Series Comparison Table

FEATURES	GS1350-6HP	GS1350-12HP	GS1350-18HP	GS1350-26HP
Number of 10/100/1000 Mbps Ethernet ports	5	10	16	24
Number of 10/100/1000 Mbps PoE ports	5	8	16	24
Number of GbE combo ports (dual personality interfaces)	No	No	2	2
Number of 1 Gbps SFP interfaces	1	2	No	No
4-pin console port (for troubleshooting only)	Yes	Yes	Yes	Yes
Auto-Fan	Fanless	Yes	Yes	Yes
Wall-mount	Yes	Yes	No	No
Rack-mount	No	Yes	Yes	Yes

1.1.1 Management Modes

NebulaFlex means you can set the Switch to operate in either standalone or cloud mode (but not both at the same time).

Use the Web Configurator to configure and manage the Switch directly in standalone mode or use Nebula Control Center (NCC) to configure and manage the Switch in cloud mode. The Nebula Control Center (NCC) is an alternative cloud-based network management system that allows you to remotely manage and monitor the Switch. You may also access the Web Configurator in cloud mode.

Nebula Cloud Management

To have Nebula manage the Switch, you must first register it at the Nebula web portal at <https://nebula.zyxel.com>, and ensure that **Nebula Control Center (NCC) Discovery** is enabled in **SYSTEM > Cloud Management** in the Switch Web Configurator.

Note: See the Switch's datasheet for the feature differences between standalone and Nebula cloud management modes. You can find the Switch's datasheet at the Zyxel website.

See the NCC (Nebula Control Center) User's Guide for how to configure the Switch using Nebula.

Figure 1 NCC Example Network Topology

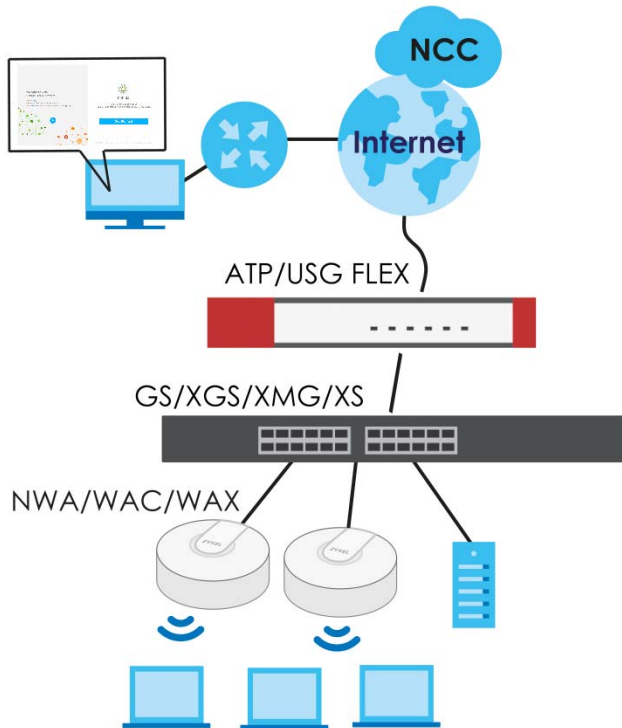

1.1.2 Mode Changing

This section describes how to change the Switch's management mode. Refer to the Switch's standalone mode User's Guide for LED descriptions, including **CLOUD** LED behavior.

From Standalone to Nebula Cloud Management

To manage your Switch through Nebula, connect the Switch to the Internet, and register it to a site and organization at the Nebula web portal (<https://nebula.zyxel.com>).

See the following steps or the Switch Quick Start Guide for registering the Switch.

Go to the NCC to Register the Switch

- 1 Go to the Nebula web portal in one of three ways.

- Enter <https://nebula.zyxel.com> in a supported web browser. See the Nebula User's Guide for more information about supported browsers.
 - Click **Visit Nebula** in the Switch's login page.
 - Click the **Nebula Control Center** icon in the upper right of the Switch's Web Configurator.
- 2 Click **Get Started** in the Nebula web portal. Enter your myZyxel account information. You will be redirected to another screen where you can sign up for a myZyxel account if you do not have one.
 - 3 Create an organization and a site (using the Nebula setup wizard) or select an existing site.
 - 4 Register the Switch by entering its Registration MAC address and serial number and assign it to the site. The serial number and Registration MAC address can be found in the **DASHBOARD** screen or the device back label on the Switch.

Use the Zyxel Nebula Mobile App to Register the Switch

- 1 Download and open the Zyxel Nebula Mobile app in your mobile device (see [Section on page 120](#) to download the app). Click **Start** on the first page. Click **Create account** to create a myZyxel account or enter your existing account information to log in.
- 2 Create an organization and site, or select an existing site using the Zyxel Nebula Mobile app.
- 3 Select a site and scan the Switch's QR code or manually enter the information to add it to the site. You can find the QR code:
 - On a label on the Switch or
 - On its box or
 - In the Web Configurator at **SYSTEM > Cloud Management**.

See [Section 3.3 on page 46](#) for more information about the **CLOUD** LED or [Section Table 21 on page 91](#) for more information about the **Cloud Control Status** field in the **DASHBOARD** screen to see if the Switch goes into Nebula cloud management mode successfully.

Local Credentials Password

The Switch goes into Cloud mode automatically after it can access the Nebula web portal and is successfully registered there. Its login password and settings are then overwritten with what you have configured in the Nebula web portal. To access the Web Configurator when the Switch is in Cloud mode, use the Local credentials password to login.

Note: The **Local credentials: Password** can be found in **Site-wide > Configure > Site settings > Device configuration** in the NCC portal. See the NCC User's Guide for more information.

Figure 2 Site-wide > Configure > Site settings: Device configuration: Local credentials

The screenshot shows the ZyNebula configuration interface. At the top, there is a breadcrumb trail: "Site-wide > Configure > Site settings". Below this, the "Site settings" section is visible, containing "Site information" with fields for "Site name" (ZyNet TW-2), "Local time zone" (Taiwan), and "Site location". Below the "Site location" field is a note: "This site location will apply to your new added device(s) as address on map automatically." The "Device configuration" section is highlighted with a red box and contains "Local credentials" with "Username: admin" and a "Password:" field with masked characters. A note below the password field states: "Password must be at least 8 characters in length and consists of letters and numerals. The valid characters are letters, numerals and symbols as follow : ~ ! @ # \$ % ^ & * () _ + ' - = { } ; : < > .".

Table 2 Management Method Comparison

MODE	ACCESS	LOGIN USER NAME	LOGIN PASSWORD	LOGIN IP ADDRESS/URL/ DOMAIN NAME
Cloud mode	NCC (Nebula Control Center) portal	myZyxell account name	myZyxel account password	https://nebula.zyxel.com
	Web Configurator (Local GUI)	admin	Local credentials password	https://setup.zyxel OR https://DHCP-assigned IP OR a configured static IP address
<p>In Cloud mode, you can configure the Switch using both NCC and the Local GUI.</p> <p>The settings you configure in the Local GUI will apply to the Switch but will not appear in the NCC settings. The settings you configure in NCC will overwrite the Local GUI settings. It is the latest settings that will apply to the Switch.</p> <p>Note: To avoid inconsistency, we recommend you use NCC to configure the Switch and only use the Local GUI for troubleshooting.</p>				
Standalone mode	Web Configurator	admin	1234	https://setup.zyxel OR https://DHCP-assigned IP OR https://192.168.1.1

The following table describes the difference between the Web Configurator in Standalone mode and Cloud mode.

Table 3 Web Configurator Comparison Table

FEATURES	STANDALONE MODE	CLOUD MODE
Default login password	1234	Local credentials password
Custom Default in MAINTENANCE > Configuration > Save Configuration	Yes	No
Custom Default in MAINTENANCE > Reboot System	Yes	No

From Nebula-managed to Standalone

To return to direct management standalone mode, remove (unregister) the Switch from the inventory in the Nebula web portal.

Note: When you change the Switch's management mode from Cloud mode to standalone mode, the Switch will reboot and restore its factory-default settings.

To unregister the Switch:

- 1 Go to the Nebula Control Center (<https://nebula.zyxel.com>).
- 2 Go to the **Organization-wide > License & inventory > Devices** screen.
- 3 Select the Switch you want to remove (unregister) from the organization.
- 4 Click **Actions**, then click **Remove from organization**.

It will take a while for the Switch to reboot and reset to factory default.

1.1.3 ZON Utility

With its built-in Web Configurator, including the Neighbor Management feature ([Section 12.1 on page 103](#)), viewing, managing and configuring the Switch and its neighboring devices is simplified.

In addition, Zyxel offers a proprietary software program called Zyxel One Network (ZON) Utility, it is a utility tool that assists you to set up and maintain network devices in a more simple and efficient way. You can download the ZON Utility at www.zyxel.com and install it on a PC (Windows operation system). For more information on ZON Utility see [Section 4.3 on page 56](#).

1.1.4 Web Configurator Surveillance Mode

Aside from the Web Configurator in Standard mode, you can switch to Surveillance mode that is specifically designed for configuring and managing PoE devices like IP cameras.

1.1.5 PoE

The Switch is a Power Sourcing Equipment (PSE) because it provides a source of power through its Ethernet ports. Each device that receives power through an Ethernet port is a Powered Device (PD).

The Switch can adjust the power supplied to each PD according to the PoE standard the PD supports. PoE standards are:

- IEEE 802.3af Power over Ethernet (PoE)
- IEEE 802.3at Power over Ethernet (PoE) +
- IEEE 802.3bt Power over Ethernet (PoE) ++

The following table describes the PoE features of the Switch by PoE standard.

Table 4 GS1350 Series Models and PoE Features

POE FEATURES	GS1350-6HP	GS1350-12HP	GS1350-18HP	GS1350-26HP
IEEE 802.3af PoE	Yes	Yes	Yes	Yes
IEEE 802.3at PoE+	Yes	Yes	Yes	Yes
IEEE 802.3bt PoE++	Yes (port1 and port2 only)	No	No	No
Power Management Mode	Consumption Classification	Consumption Classification	Consumption Classification	Consumption Classification
PoE Power Budget	60 W	130 W	250 W	375 W

Table 5 PoE Standards

POE FEATURES	PoE	PoE+	PoE++
IEEE Standard	IEEE 802.3af	IEEE 802.3at	IEEE 802.3bt
PoE Type	Type 1	Type 2	Type 3
Switch Port Power			
IEEE Power Classification	Class 0, 1, 2, 3	Class 4	Class 5, 6
Maximum Power Per Port	15.4 W	30 W	60 W
Port Voltage Range	44 – 57 V	50 – 57 V	50 – 57 V
Cables			
Twisted Pairs Used	2-pair	2-pair	4-pair
Supported Cables	Cat3 or better	Cat5 or better	Cat5 or better

1.2 Example Applications

This section shows a few examples of using the Switch in various network environments. Note that the Switch in the figure is just an example Switch and not your actual Switch.

1.2.1 PoE Example Application

The following example figure shows a Switch supplying PoE (Power over Ethernet) to Powered Devices (PDs) such as an IP camera, a wireless router, an IP telephone and a general outdoor router that are not within reach of a power outlet.

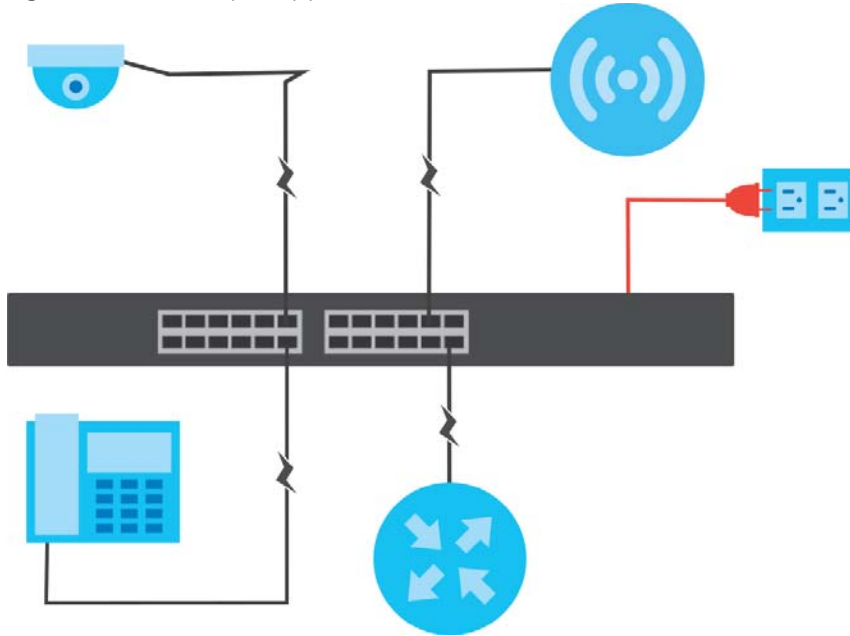
Figure 3 PoE Example Application

1.2.2 Backbone Example Application

The Switch is an ideal solution for small networks where rapid growth can be expected in the near future. The Switch can be used standalone for a group of heavy traffic users. You can connect computers and servers directly to the Switch's port or connect other switches to the Switch.

In this example, all computers can share high-speed applications on the server. To expand the network, simply add more networking devices such as switches, routers, computers, print servers, and so on.

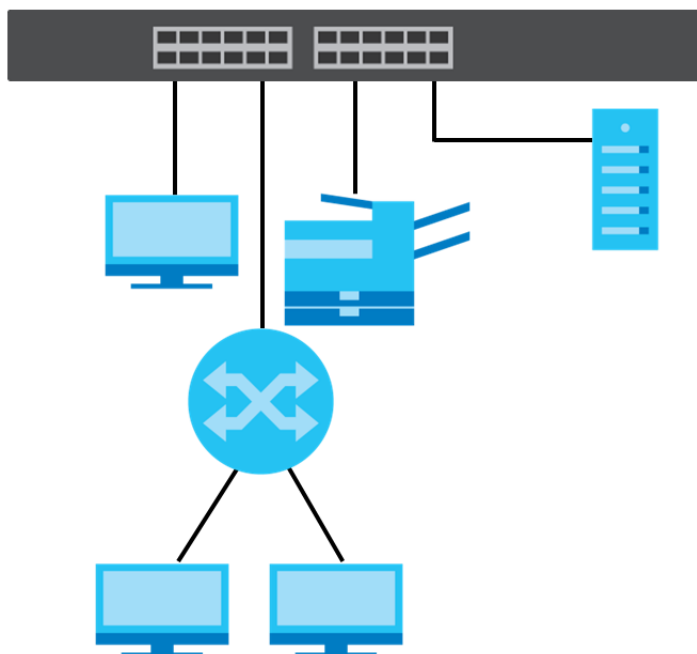
Figure 4 Backbone Application

1.2.3 Bridging or Fiber Optic Uplink Example Application

In this example, the Switch connects different company departments (**RD** and **Sales**) to the corporate backbone. It can alleviate bandwidth contention and eliminate server and network bottlenecks. All users that need high bandwidth can connect to high-speed department servers through the Switch. You can provide a super-fast uplink connection by using a Gigabit Ethernet or SFP port on the Switch.

Moreover, the Switch eases supervision and maintenance by allowing network managers to centralize multiple servers at a single location.

Figure 5 Bridging or Fiber Optic Uplink Example Application

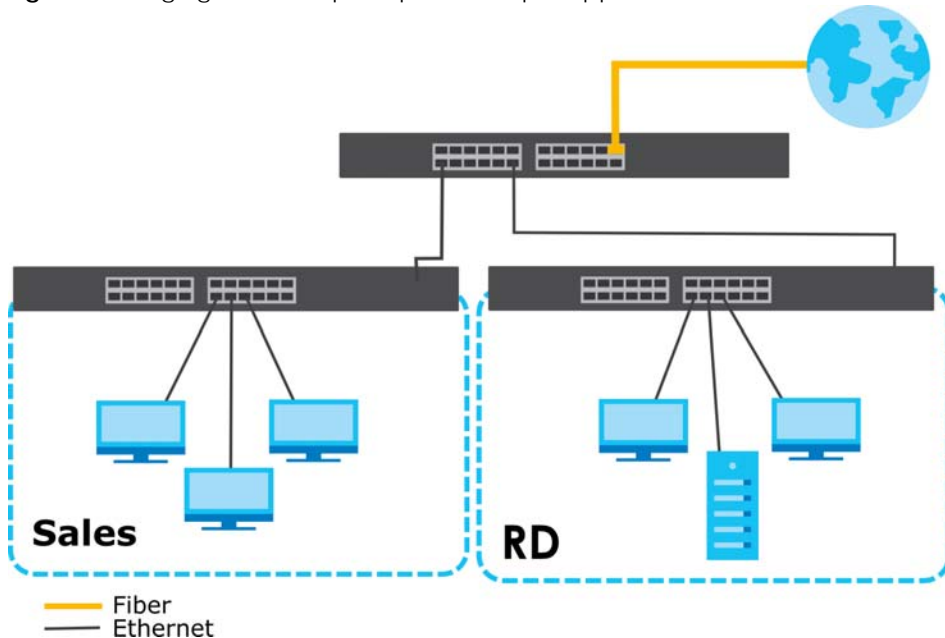

1.2.4 High Performance Switching Example

The Switch is ideal for connecting two networks that need high bandwidth. In the following example, use link aggregation (trunking) to connect these two networks.

Switching to higher-speed LANs such as ATM (Asynchronous Transmission Mode) is not feasible for most people due to the expense of replacing all existing Ethernet cables and adapter cards, restructuring your network and complex maintenance. The Switch can provide the same bandwidth as ATM at much lower cost while still being able to use existing adapters and switches. Moreover, the current LAN structure can be retained as all ports can freely communicate with each other.

This helps you switch to higher-speed LANs without the need for replacing all existing Ethernet cables and adapter cards, restructuring your network and complex maintenance.

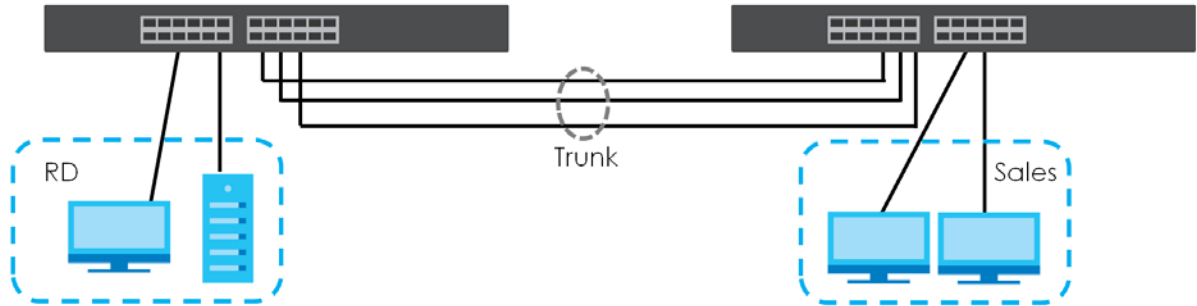
Figure 6 High Performance Switched Workgroup Application

1.2.5 IEEE 802.1Q VLAN Application Examples

A VLAN (Virtual Local Area Network) allows a physical network to be partitioned into multiple logical networks. Stations on a logical network belong to one or more groups. With VLAN, a station cannot directly talk to or hear from stations that are not in the same groups unless such traffic first goes through a router.

1.2.5.1 Tag-based VLAN Example

Ports in the same VLAN group share the same frame broadcast domain thereby increase network performance through reduced broadcast traffic. VLAN groups can be modified at any time by adding, moving or changing ports without any re-cabling.

Shared resources such as a server can be used by all ports in the same VLAN as the server. In the following figure only ports that need access to the server need to be part of VLAN 1. Ports can belong to other VLAN groups too.

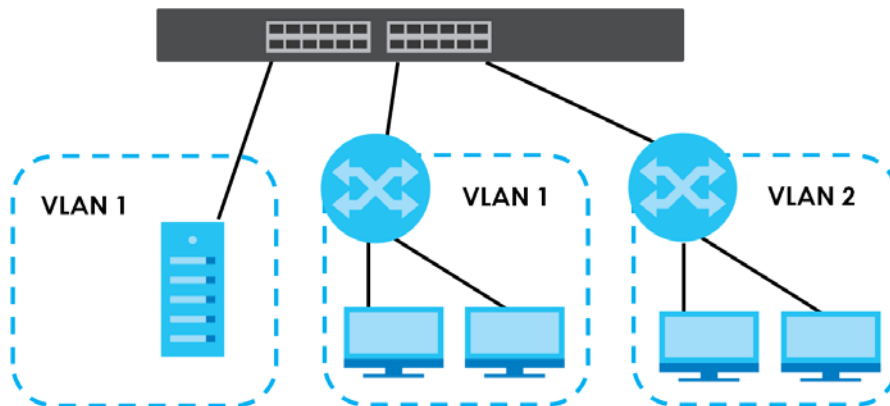
Figure 7 Shared Server Using VLAN Example

1.3 Ways to Manage the Switch

Use any of the following methods to manage the Switch.

- NCC (Zyxel Nebula Control Center). With the NCC, you can remotely manage and monitor the Switch through a cloud-based network management system. See the NCC User's Guide for detailed information about how to access the NCC and manage your Switch through the NCC. See the NCC User's Guide for how to configure Nebula managed devices.

- Web Configurator in Standard or Surveillance mode. This is recommended for everyday management of the Switch using a (supported) web browser. See [Chapter 4 on page 50](#).
- Command Line Interface. Line commands offer an alternative to the Web Configurator and in some cases are necessary to configure advanced features. See the CLI Reference Guide.
- FTP. Use File Transfer Protocol for firmware upgrades and configuration backup or restore. See [Section 59.3.1 on page 340](#).
- SNMP. The Switch can be monitored and/or managed by an SNMP manager. See [Section 24.6.1 on page 154](#).
- Cluster Management. Cluster Management allows you to manage multiple switches through one switch, called the cluster manager. See [Chapter 59 on page 342](#).
- ZON Utility. ZON Utility is a program designed to help you deploy and perform initial setup on a network more efficiently. See [Section 4.3 on page 56](#).

1.4 Good Habits for Managing the Switch

Do the following regularly to make the Switch more secure and to manage the Switch more effectively.

- Change the password. Use a password that is not easy to guess and that consists of different types of characters, such as numbers and letters.
- Write down the password and put it in a safe place.
- Back up the configuration (and make sure you know how to restore it). Restoring an earlier working configuration may be useful if the device becomes unstable or even crashes. If you forget your password, you will have to reset the Switch to its factory default settings. If you backed up an earlier configuration file, you would not have to totally re-configure the Switch. You could simply restore your last configuration.

CHAPTER 2

Hardware Installation and Connection

2.1 Installation Scenarios

This chapter shows you how to install and connect the Switch.

The Switch can be:

- Placed on a desktop.
- Wall-mounted on a wall.
- Rack-mounted on a standard EIA rack.

2.2 Safety Precautions

Please observe the following before using the Switch:

- It is recommended to ask an authorized technician to attach the Switch on a desk or to the rack or wall. Use the proper screws to prevent damage to the Switch. See the **Installation Requirements** sections in this chapter to know the types of screws and screwdrivers for each mounting method.
- Make sure there is at least 2 cm of clearance on the top and bottom of the Switch, and at least 5 cm of clearance on all four sides of the Switch. This allows air circulation for cooling.
- Do NOT block the ventilation holes nor store cables or power cords on the Switch. Allow clearance for the ventilation holes to prevent your Switch from overheating. This is especially crucial when your Switch does not have fans. Overheating could affect the performance of your Switch, or even damage it.
- The surface of the Switch could be hot when it is functioning. Do NOT put your hands on it. You may get burned. This could happen especially when you are using a fanless Switch.
- The Switches with fans are not suitable for use in locations where children are likely to be present.

To start using the Switch, simply connect the power cables to turn it on.

2.3 Freestanding Installation Procedure

- 1 Make sure the Switch is clean and dry.
- 2 Remove the adhesive backing from the rubber feet.

- 3 Attach the rubber feet to each corner on the bottom of the Switch. These rubber feet help protect the Switch from shock or vibration and ensure space between devices when stacking.

Figure 8 Attaching Rubber Feet

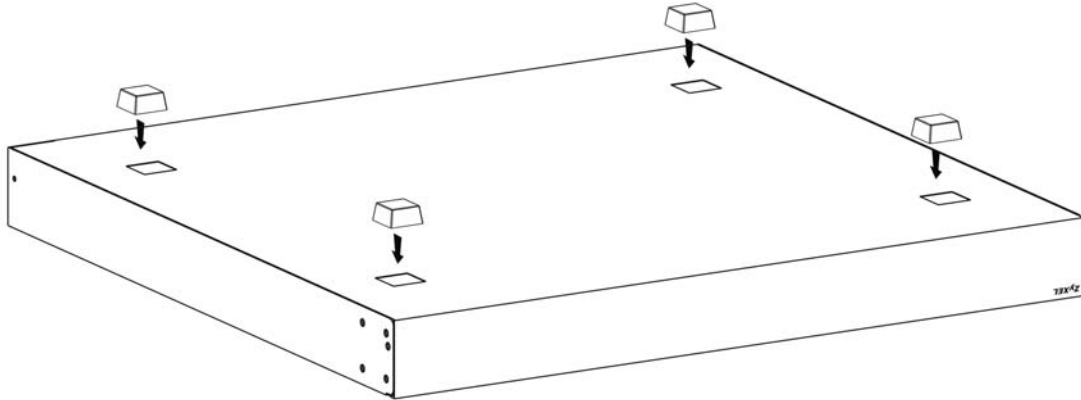

- 4 Set the Switch on a smooth, level surface strong enough to support the weight of the Switch and the connected cables. Make sure there is a power outlet nearby.

Cautions:

- Avoid stacking fanless Switches to prevent overheating.
- Ensure enough clearance around the Switch to allow air circulation for cooling.
- Do NOT remove the rubber feet as it provides space for air circulation.

2.4 Wall Mount

The Switch can be mounted on a wall. You may need screw anchors if mounting on a concrete or brick wall.

2.4.1 Installation Requirements

- Distance above the floor: At least 1.8 m (5.9 feet)
- Distance between holes: 78 mm (3.071 inches)
- Two M4 screws and a #2 Phillips screwdriver
- Two screw anchors (optional)

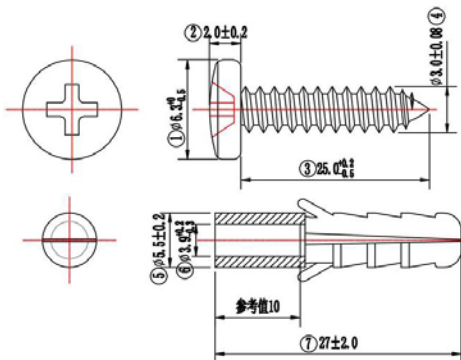

Do the following to attach your Switch to a wall.

- 1 Select a position free of obstructions on a wall strong enough to hold the weight of the Switch.
- 2 Mark two holes on the wall at the appropriate distance apart for the screws.

WARNING! Be careful to avoid damaging pipes or cables located inside the wall when drilling holes for the screws.

- 3 If using screw anchors, drill two holes for the screw anchors into the wall. Push the anchors into the full depth of the holes, then insert the screws into the anchors. Do NOT insert the screws all the way in – leave a small gap of about 0.5 cm.
If not using screw anchors, use a screwdriver to insert the screws into the wall. Do NOT insert the screws all the way in – leave a gap of about 0.5 cm.
- 4 Make sure the screws are fastened well enough to hold the weight of the Switch with the connection cables.
- 5 Align the holes on the back of the Switch with the screws on the wall. Hang the Switch on the screws.

Note: Make sure there is enough clearance between the wall and the Switch to allow ventilation.

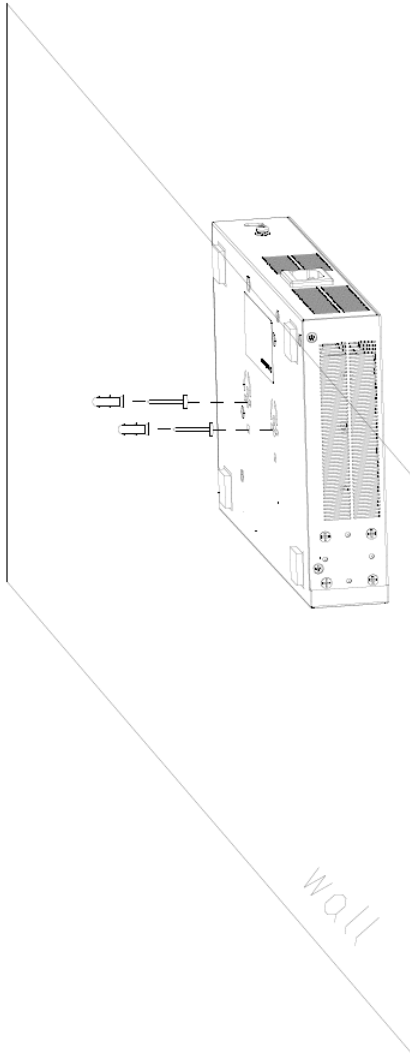

WARNING! The Switch should be wall-mounted horizontally, and make sure the front panel is facing down. The Switch's side panels with ventilation slots should not be facing up or down as this position is less safe.

2.5 Mount the Switch on a Rack

The Switch can be mounted on an EIA standard size, 19-inch rack or in a wiring closet with other equipment. Follow the steps below to mount your Switch on a standard EIA rack using a rack-mounting kit.

Note: Make sure there is enough clearance between each equipment on the rack for air circulation.

2.5.1 Installation Requirements

- Two mounting brackets.

- Eight M3 flat head screws and a #2 Philips screwdriver.
- Four M5 flat head screws and a #2 Philips screwdriver.

2.5.2 Precautions

- Make sure the rack will safely support the combined weight of all the equipment it contains. The maximum weight a bracket can hold is 21.5 kg.
- Make sure the position of the Switch does not make the rack unstable or top-heavy. Take all necessary precautions to anchor the rack securely before installing the unit.

2.5.3 Attach the Mounting Brackets to the Switch

- 1 Position a mounting bracket on one side of the Switch, lining up the four screw holes on the bracket with the screw holes on the side of the Switch.

Figure 9 Attaching the Mounting Brackets

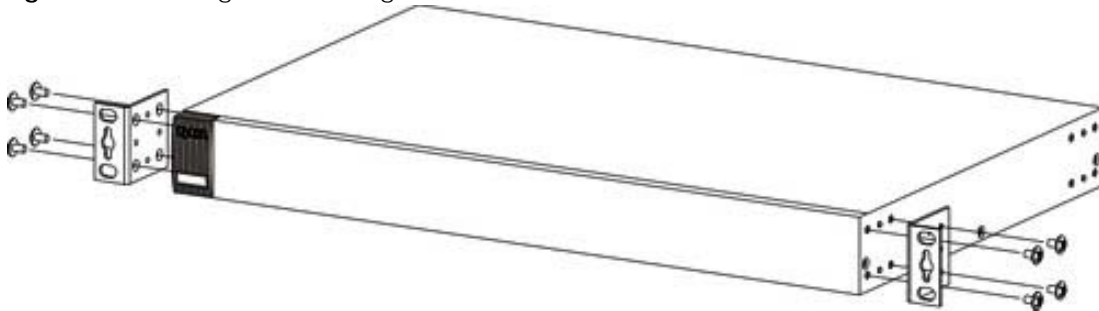

- 2 Using a #2 Philips screwdriver, install the M3 flat head screws through the mounting bracket holes into the Switch.
- 3 Repeat steps 1 and 2 to install the second mounting bracket on the other side of the Switch.
- 4 You may now mount the Switch on a rack. Proceed to the next section.

2.5.4 Mount the Switch on a Rack

- 1 Position a mounting bracket (that is already attached to the Switch) on one side of the rack, lining up the two screw holes on the bracket with the screw holes on the side of the rack.

Figure 10 Mounting the Switch on a Rack (GS1350-12HP/18HP)

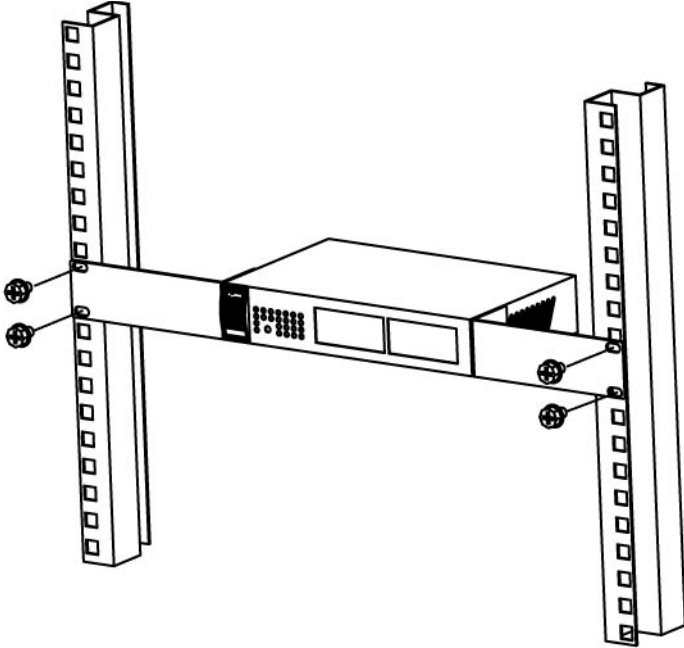
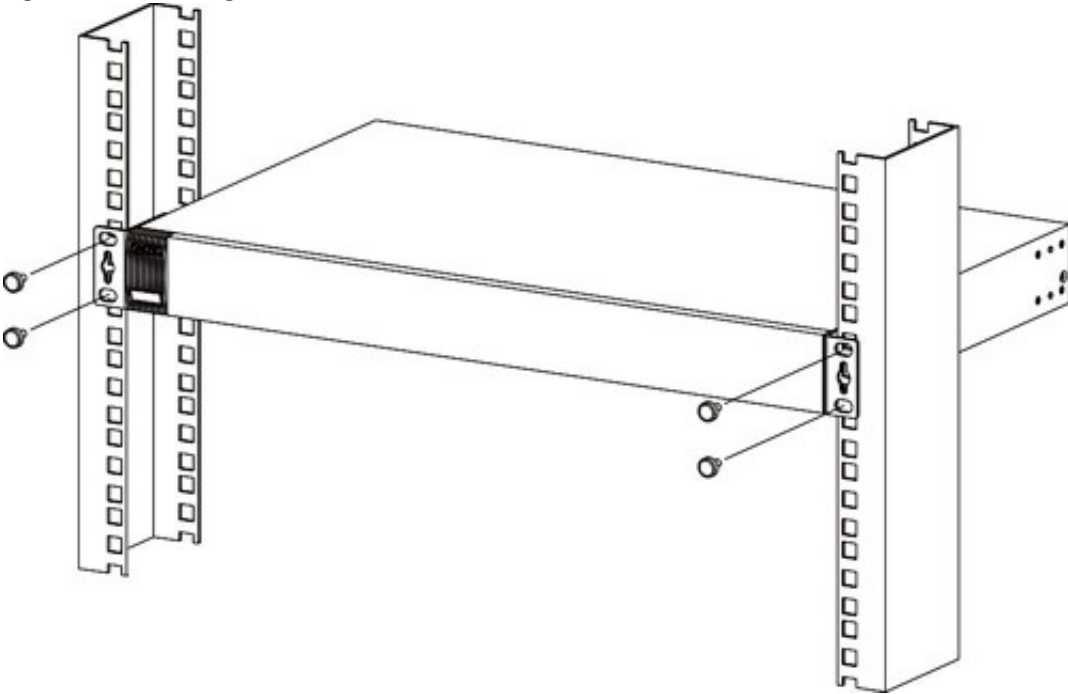

Figure 11 Mounting the Switch on a Rack (GS1350-26HP)



- 2 Using a #2 Phillips screwdriver, install the M5 flat head screws through the mounting bracket holes into the rack.

Note: Make sure you tighten all the four screws to prevent the Switch from getting slanted.

- 3 Repeat steps 1 and 2 to attach the second mounting bracket on the other side of the rack.

CHAPTER 3

Hardware Panels

This chapter describes the front panel and rear panel of the Switch and shows you how to make the hardware connections.

3.1 Front Panel Connections

The following figures show the front panels of the Switch.

Figure 12 Front Panel: GS1350-6HP



Figure 13 Front Panel: GS1350-12HP



Figure 14 Front Panel: GS1350-18HP



Figure 15 Front Panel: GS1350-26HP



The following table describes the ports.

Table 6 Panel Connections

CONNECTOR	DESCRIPTION
5/10/16/24 1000Base-T RJ-45 Ethernet Ports	These are 10/100/1000Base-T auto-negotiating and auto-crossover Ethernet ports. Connect these ports to a computer, a hub, a router, or an Ethernet switch.
5/8/16/24 1000Base-T RJ-45 PoE Ports	These are 10/100/1000Base-T auto-negotiating and auto-crossover Ethernet ports. Connect these ports to a computer, a hub, a router, or an Ethernet switch.
1/2 SFP Slots (only available for GS1350-6HP/12HP)	Use SFP transceivers in these ports for high-bandwidth backbone connections.

Table 6 Panel Connections (continued)

CONNECTOR	DESCRIPTION
2 GbE Combo Ports (Dual Personality Interfaces) (only available for GS1350-18HP/26HP)	<p>Each interface has one 10/100/1000Base-T copper RJ-45 port and one SFP slot, with one port active at a time.</p> <ul style="list-style-type: none"> 10/100/1000Base-T Ports: Connect these ports to a computer, an Ethernet switch or router. SFP Slots: Use Small Form-Factor Pluggable (SFP) transceivers in these ports for fiber optic connections to an Ethernet switch or router.
Reset	Press the RESET button to reboot the Switch without turning the power off. See Section 3.3 on page 46 for more information about the LED behavior.
Restore	<p>Press the RESTORE button for 3 to 7 seconds to have the Switch automatically reboot and restore the last-saved custom default file. See Section 3.3 on page 46 for more information about the LED behavior.</p> <p>Press the RESTORE button for more than 7 seconds to have the Switch automatically reboot and restore the factory default file. See Section 3.3 on page 46 for more information about the LED behavior.</p>
Console Port	Only connect this port to your computer (using a USB Type A console cable) if you want to configure the Switch using a computer with terminal emulation software through the console port.

3.1.1 Multi-Gigabit Ethernet Ports

The Switch has 1000Base-T auto-negotiating, auto-crossover Ethernet ports. In 10/100/1000 Mbps Gigabit Ethernet, the speed can be 10 Mbps, 100 Mbps or 1000 Mbps. The duplex mode can be half duplex or full duplex.

An auto-negotiating port can detect and adjust to the optimum Ethernet speed (10/100/1000 Mbps) and duplex mode (full duplex or half duplex) of the connected device.

An auto-crossover (auto-MDI/MDI-X) port automatically works with a straight-through or crossover Ethernet cable.

Four 1000Base-T Ethernet ports are paired with an SFP slot to create a dual personality interface. The Switch uses up to one connection for each SFP and 1000Base-T Ethernet pair. The SFP slots have priority over the Gigabit ports. This means that if an SFP slot and the corresponding GbE port are connected at the same time, the GbE port will be disabled.

Note: The combo ports (dual personality interfaces) change to fiber optic mode directly when inserting the fiber module.

When auto-negotiation is turned on, an Ethernet port negotiates with the peer automatically to determine the connection speed and duplex mode. If the peer Ethernet port does not support auto-negotiation or turns off this feature, the Switch determines the connection speed by detecting the signal on the cable and using half duplex mode. When the Switch's auto-negotiation is turned off, an Ethernet port uses the pre-configured speed and duplex mode when making a connection, thereby requiring you to make sure that the settings of the peer Ethernet port are the same in order to connect.

3.1.1.1 Default Ethernet Negotiation Settings

The factory default negotiation settings for the Gigabit ports on the Switch are:

- Speed: Auto

- Duplex: Auto
- Flow control: Off
- Link Aggregation: Disabled

3.1.1.2 Auto-crossover

All ports support auto-crossover, that is auto-MDIX ports (Media Dependent Interface Crossover), so you may use either a straight-through Ethernet cable or crossover Ethernet cable for all Gigabit port connections. Auto-crossover ports automatically sense whether they need to function as crossover or straight ports, so crossover cables can connect both computers and switches or hubs.

3.1.2 PoE

The Switch supports the IEEE 802.3af Power over Ethernet (PoE), IEEE 802.3at Power over Ethernet (PoE) plus and IEEE 802.3bt Power over Ethernet (PoE) plus plus standards. The Switch is a Power Sourcing Equipment (PSE) because it provides a source of power through its Ethernet ports. Each device that receives power through an Ethernet port is a Powered Device (PD).

3.1.3 SFP Slots

These are slots for SFP (Small Form-Factor Pluggable) transceivers. A transceiver is a single unit that houses a transmitter and a receiver. The Switch does not come with transceivers. You must use transceivers that comply with the Small Form-factor Pluggable (SFP) Transceiver MultiSource Agreement (MSA). See the SFF committee's INF-8074i specification Rev 1.0 for details.

You can change transceivers while the Switch is operating. You can use different transceivers to connect to Ethernet switches with different types of fiber optic or even copper cable connectors.

- Type: SFP connection interface
- Connection speed: 100/1000 Mbps

WARNING! To avoid possible eye injury, do not look into an operating fiber optic module's connectors.

HANDLING! All transceivers are static sensitive. To prevent damage from electrostatic discharge (ESD), it is recommended you attach an ESD preventive wrist strap to your wrist and to a bare metal surface when you install or remove a transceiver.

STORAGE! All modules are dust sensitive. When not in use, always keep the dust plug on. Avoid getting dust and other contaminant into the optical bores, as the optics do not work correctly when obstructed with dust.

3.1.3.1 Transceiver Installation

Use the following steps to install a transceiver.

- 1 Attach an ESD preventive wrist strap to your wrist and to a bare metal surface.
- 2 Align the transceiver in front of the slot opening.

- 3 Make sure the latch is in the lock position (latch styles vary), then insert the transceiver into the slot with the exposed section of PCB board facing down.
- 4 Press the transceiver firmly until it clicks into place.
- 5 The Switch automatically detects the installed transceiver. Check the LEDs to verify that it is functioning properly.
- 6 Remove the dust plugs from the transceiver and cables (dust plug styles vary).
- 7 Identify the signal transmission direction of the fiber optic cables and the transceiver. Insert the fiber optic cable into the transceiver.

Figure 16 Latch in the Lock Position

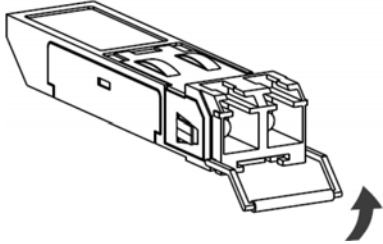

Figure 17 Transceiver Installation Example

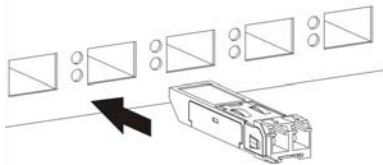
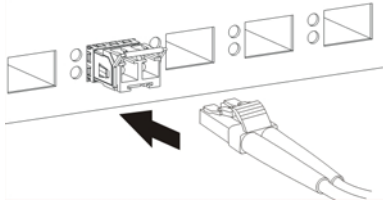

Figure 18 Connecting the Fiber Optic Cables



3.1.3.2 Transceiver Removal

Use the following steps to remove an SFP transceiver.

- 1 Attach an ESD preventive wrist strap to your wrist and to a bare metal surface on the chassis.
- 2 Remove the fiber optic cables from the transceiver.
- 3 Pull out the latch and down to unlock the transceiver (latch styles vary).

Note: Make sure the transceiver's latch is pushed all the way down, so the transceiver can be pulled out successfully.

- 4 Pull the latch, or use your thumb and index finger to grasp the tabs on both sides of the transceiver, and carefully slide it out of the slot.

Note: Do NOT pull the transceiver out by force. You could damage it. If the transceiver will not slide out, grasp the tabs on both sides of the transceiver with a slight up or down motion and carefully slide it out of the slot. If unsuccessful, contact Zyxel Support to prevent damage to your Switch and transceiver.

- 5 Insert the dust plug into the ports on the transceiver and the cables.

Figure 19 Removing the Fiber Optic Cables

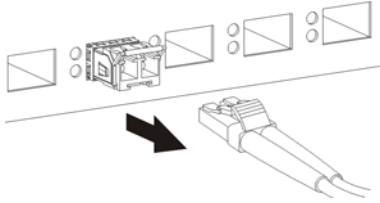

Figure 20 Opening the Transceiver's Latch Example

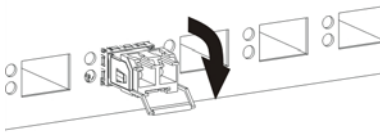
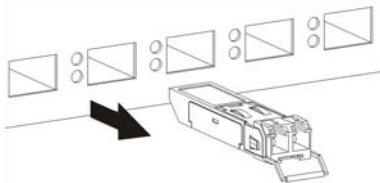

Figure 21 Transceiver Removal Example



3.1.4 Dual Personality Interfaces

A combo port is for uplink connections. It consists of a Gigabit Ethernet port for Ethernet connection, and a SFP transceiver slot for fiber optic connection. The fiber optic connection takes priority if the corresponding Gigabit port is also connected.

- 100 Mbps/1 Gbps – Connect these ports to high-bandwidth backbone network Ethernet switches.
- Transceiver Slots – Use SFP transceivers in these slots for connections to backbone Ethernet switches.

Figure 22 Combo Port Example: Gigabit Port and SFP Transceiver Slot

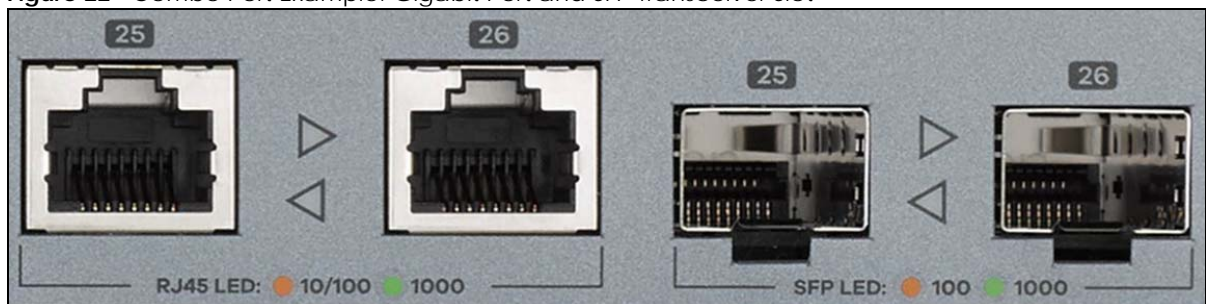

3.1.5 Console Port

This console port is for troubleshooting only. With instructions from customer support, connect the 4-pin connector of the USB Type A console cable to the console port of the Switch. Then connect the other

end to a USB port on your computer. You can use a computer with terminal emulation software configured to the following parameters:

- VT100 terminal emulation
- 115200 bps
- No parity, 8 data bits, 1 stop bit
- No flow control

3.2 Rear Panel

The following figures show the rear panel of the Switch. The rear panel contains:

Figure 23 Rear Panel: GS1350-6HP



Figure 24 Rear Panel: GS1350-12HP

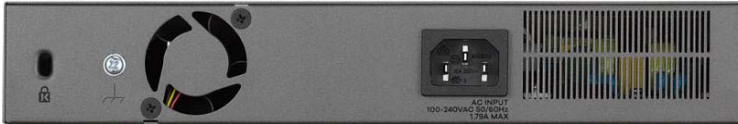

Figure 25 Rear Panel: GS1350-18HP

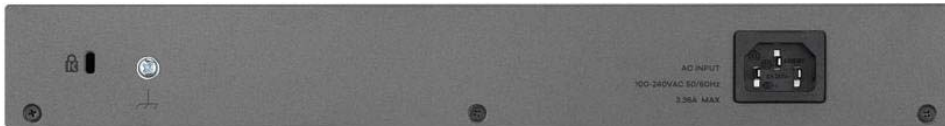

Figure 26 Rear Panel: GS1350-26HP



3.2.1 Grounding

Grounding is a safety measure to direct excess electric charge to the ground. It prevents damage to the Switch, and protects you from electrocution. Use the grounding screw on the rear panel and the ground wire of the AC power supply to ground the Switch.

The grounding terminal and AC power ground where you install the Switch must follow your country's regulations. Qualified service personnel must ensure the building's protective earthing terminals are valid terminals.

Installation of Ethernet cables must be separate from AC power lines. To avoid electric surge and electromagnetic interference, use a different electrical conduit or raceway (tube/trough or enclosed conduit for protecting electric wiring) that is 15 cm apart, or as specified by your country's electrical regulations.

Any device that is located outdoors and connected to this product must be properly grounded and surge protected. To the extent permissible by your country's applicable law, failure to follow these guidelines could result in damage to your Switch which may not be covered by its warranty.

Note: The specification for surge or ESD protection assumes that the Switch is properly grounded.

- 1 Remove the M4 ground screw from the Switch's rear panel.
- 2 Secure a green or yellow ground cable (16 AWG or smaller) to the Switch's rear panel using the M4 ground screw.

Figure 27 Grounding

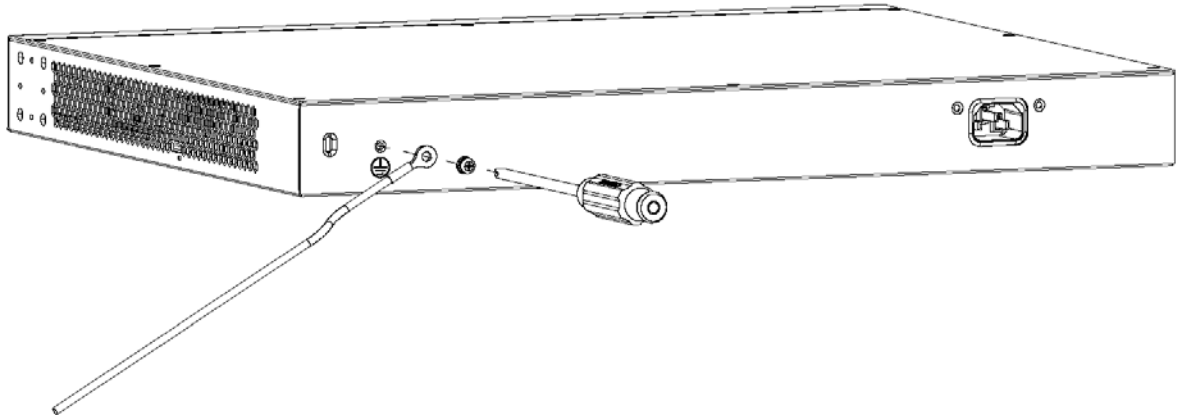

- 3 Attach the other end of the ground cable to a grounding bar located on the rack where you install the Switch or to an on-site grounding terminal.

Figure 28 Attach Ground Cable to Grounding Bar or On-site Grounding Terminal

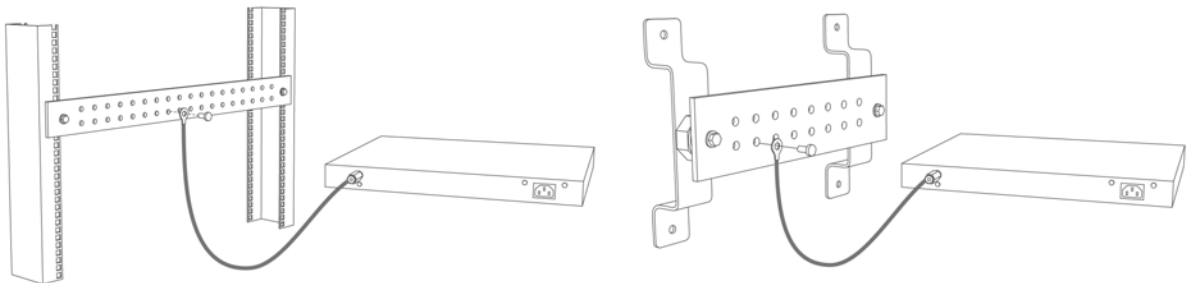

- 4 The grounding terminal of the server rack or on-site grounding terminal must also be grounded and connected to the building's main grounding electrode. Make sure the grounding terminal is connected to the buildings grounding electrode and has an earth resistance of less than 10 ohms, or according to your country's electrical regulations.

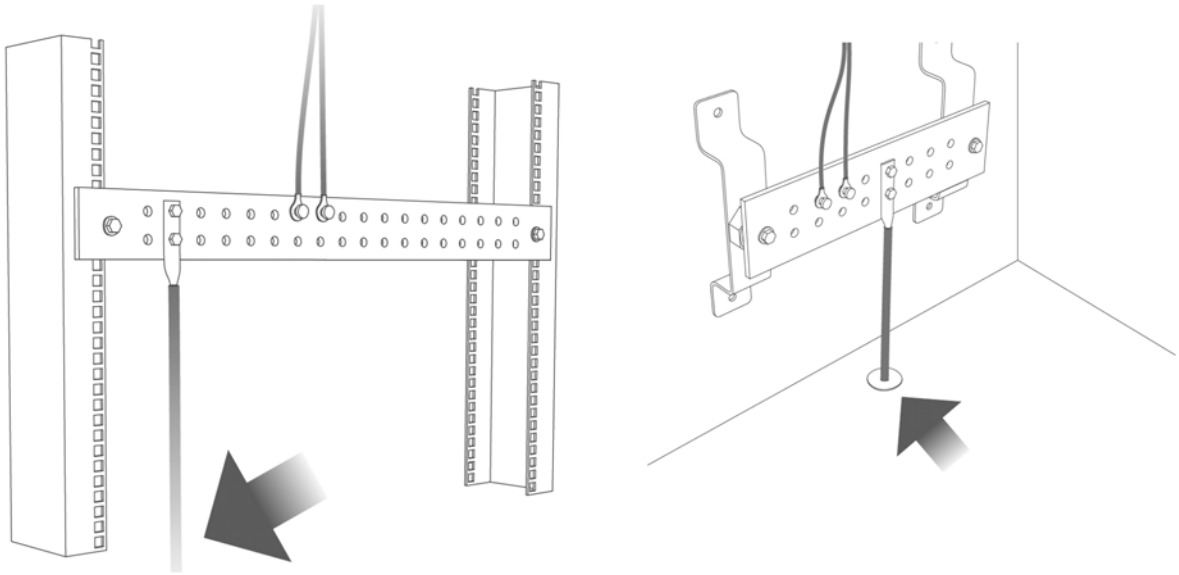
Figure 29 Connecting to the Building's Main Grounding Electrode

If you are uncertain that suitable grounding is available, contact the appropriate electrical inspection authority or an electrician.

This device must be grounded. Do this before you make other connections.

3.2.2 AC Power Connection

Note: Make sure you are using the correct power source as shown on the panel and that no objects obstruct the airflow of the fans (located on the side of the unit).

GS1350-6HP: Connect the supplied power adapter to the power receptacle on the rear panel. Then use the included power cord to connect the power adapter to an appropriate power source. Set the power switch to the ON position.

GS1350-12HP/18HP/26HP: To connect power to the Switch, insert the female end of the supplied power cord to the AC power receptacle on the rear panel. Connect the other end of the power cord to an appropriate power outlet.

3.2.3 Power Connection

Note: Make sure you are using the correct power source and that no objects obstruct the airflow of the fans.

The Switch uses two power supply modules, one of which is redundant, so if one power module fails the system can operate on the remaining module.

Rear Panel Power Connection

Connect one end of the supplied power cord or power adapter to the power receptacle on the back of the Switch and the other end to the appropriate power source.

Connecting the Power

Use the following procedures to connect the Switch to a power source after you have installed it in a rack.

Note: Use the included power cord for the AC power connection.

- 1 Connect the female end of the power cord to the AC power socket.
- 2 Connect the other end of the cord to a power outlet.

Disconnecting the Power

The power input connectors can be disconnected from the power source individually.

- 1 Disconnect the power cord from the power outlet.
- 2 Disconnect the power cord from the AC power socket.

3.3 LEDs

After you connect the power to the Switch, view the LEDs to ensure proper functioning of the Switch and as an aid in troubleshooting.

Table 7 LED Descriptions

LED	COLOR	STATUS	DESCRIPTION
PWR	Green	On	The Switch is receiving power from the power module in the power slot.
		Blinking	The Switch is returning to the last-saved custom default configuration settings.
	Amber	On	The Switch is returning to its factory default configuration settings.
		Off	The Switch is not receiving power from the power module in the power slot.
SYS	Green	On	The Switch is on and functioning properly.
		Blinking	The Switch is rebooting and performing self-diagnostic tests.
	Red	On	The Switch is functioning abnormally.
		Off	The power is off or the Switch is not ready or malfunctioning.

Table 7 LED Descriptions (continued)

LED	COLOR	STATUS	DESCRIPTION	
CLOUD	Green	On	The Switch has successfully connected to the NCC (Nebula Control Center).	
		Blinking	The Switch cannot connect to the NCC because it is not registered.	
	Amber	On	The Switch is registered at NCC but cannot connect to the NCC. Please check the Internet connection of the Switch.	
		Blinking	The Switch is not registered at NCC and cannot connect to the NCC. Please check the Internet connection of the Switch and register the Switch at NCC.	
		Off	The Switch is operating in standalone mode. Nebula Control Center Discovery is disabled in SYSTEM > Cloud Management in the Switch's Web Configurator.	
LOCATOR	Blue	On	The Switch is uploading firmware. While the Switch is doing this, do NOT turn off the power.	
		Blinking	Shows the actual location of the Switch between several devices in a rack. The default timer is 30 minutes when you are configuring the Switch.	
		Off	The locator is not functioning or malfunctioning.	
PoE Usage MAX Bar1 is the bar at the bottom; bar 5 is the bar at the top.	Green (Bar1 – Bar3)	On	Each bar represents 20 percent of PoE Power consumption. Bar 1: PoE power usage is below 20 percent of the power supplied budget. Bar 2: PoE power usage is below 40 percent of the power supplied budget, but over 20 percent of the power supplied budget. Bar 3: PoE power usage is below 60 percent of the power supplied budget, but over 40 percent of the power supplied budget.	
		Yellow (Bar4)	On	PoE power usage is below 80 percent of the power supplied budget, but over 60 percent of the power supplied budget.
		Red (Bar5)	On	PoE power usage is more than 80 percent of the power supplied budget.
	Blinking		Less than 5 percent of the power supplied budget remains. 5 percent is the default value.	
		Off	PoE power usage is 0 percent of the power supplied budget.	
Ethernet Ports and PoE				
LNK/ACT 1 – 5 (GS1350-6HP) 1 – 8 (GS1350-12HP) 1 – 16 (GS1350-18HP) 1 – 24 (GS1350-26HP)	Green	Blinking	The Switch is transmitting or receiving to or from a 1000 Mbps Ethernet network.	
		On	The link to a 1000 Mbps Ethernet network is up.	
	Amber	Blinking	The Switch is transmitting or receiving to or from a 10 Mbps or a 100 Mbps Ethernet network.	
		On	The link to a 10 Mbps or a 100 Mbps Ethernet network is up.	
		Off	The link to an Ethernet network is down.	

Table 7 LED Descriptions (continued)

LED	COLOR	STATUS	DESCRIPTION
PoE Mode 1 – 5 (GS1350-6HP) 1 – 8 (GS1350-12HP) 1 – 16 (GS1350-18HP) 1 – 24 (GS1350-26HP)	Green	On	Power supplied to all PoE Ethernet ports meets the IEEE 802.3at/bt standard.
	Amber	On	Power supplied to all PoE Ethernet ports meets the IEEE 802.3af standard.
		Off	There is no power supplied.
Dual Personality Interface			
Ethernet Ports 17 – 18 (GS1350-18HP) 25 – 26 (GS1350-26HP)	Green	Blinking	The Switch is transmitting or receiving to or from a 1000 Mbps Ethernet network.
		On	The link to a 1000 Mbps Ethernet network is up.
	Amber	Blinking	The Switch is transmitting or receiving to or from a 10 Mbps or a 100 Mbps Ethernet network.
		On	The link to a 10 Mbps or a 100 Mbps Ethernet network is up.
	Off	The link to an Ethernet network is down.	
SFP Slots 17 – 18 (GS1350-18HP) 25 – 26 (GS1350-26HP)	Green	On	The uplink port is linking at 1000 Mbps.
		Blinking	The Switch is transmitting or receiving data 1000 Mbps.
	Amber	On	The uplink port is linking at 100 Mbps.
		Blinking	The Switch is transmitting or receiving data 100 Mbps.
	Off	There is no link or port, the uplink port is shut down.	
10/100/1000Base-T Ethernet Ports			
9 – 10 (GS1350-12HP)	Green	Blinking	The Switch is transmitting or receiving to or from a 1000 Mbps Ethernet network.
		On	The link to a 1000 Mbps Ethernet network is up.
	Amber	Blinking	The Switch is transmitting or receiving to or from a 10 Mbps or a 100 Mbps Ethernet network.
		On	The link to a 10 Mbps or a 100 Mbps Ethernet network is up.
	Off	The link to an Ethernet network is down.	
1G SFP Slots			
6 (GS1350-6HP) 11 – 12 (GS1350-12HP)	Green	On	The uplink port is linking at 1000 Mbps.
		Blinking	The Switch is transmitting or receiving data 1000 Mbps.
	Amber	On	The uplink port is linking at 100 Mbps.
		Blinking	The Switch is transmitting or receiving data 100 Mbps.
	Off	There is no link or port, the uplink port is shut down.	

PART II

Technical Reference

CHAPTER 4

Web Configurator

4.1 Overview

This section introduces the configuration and functions of the Web Configurator.

The Web Configurator is an HTML-based management interface that allows easy system setup and management through a web browser. Use a web browser that supports HTML5, such as Microsoft Edge, Mozilla Firefox, or Google Chrome. The recommended minimum screen resolution is 1024 by 768 pixels.

In order to use the Web Configurator you need to allow:

- Web browser pop-up windows on your computer.
- JavaScript (enabled by default).
- Java permissions (enabled by default).

Note: In Cloud mode, the settings you configure in the Web Configurator will apply to the Switch but will not appear in the Nebula settings. The settings you configure in Nebula will overwrite the Web Configurator settings. It is the latest settings that will apply to the Switch.

Note: To avoid inconsistency, we recommend you use Nebula to configure the Switch and only use the Web Configurator for troubleshooting.

4.2 System Login

- 1 Start your web browser.
- 2 The Switch is a DHCP client by default. Type "https://DHCP-assigned IP" in the **Location** or **Address** field. Press [ENTER].

Note: You can always use the domain name "setup.zyxel" to access the Web Configurator whether the Switch is using a DHCP-assigned IP or static IP address. This requires your computer to be directly connected to the Switch. Make sure your computer can connect to a DNS server through the Switch.

If the Switch is not connected to a DHCP server, type "https://" and the static IP address of the Switch (for example, the default management IP address is 192.168.1.1 through an in-band port) in the **Location** or **Address** field. Press [ENTER]. Your computer must be in the same subnet in order to access this website address.

Also, you can use the ZON Utility to check your Switch's IP address. See [Section 4.3 on page 56](#) for more information on the ZON utility.

- 3 If a “Your connection is not private” screen appears, click **Advanced** and **Proceed to DHCP-assigned IP (unsafe)** to go to the **Login** screen. This screen appears as the Zyxel Device uses a certificate for the HTTPS connection. See [Section 59.2 on page 338](#) for information on using an HTTPS certificate verified by a third party to create secure HTTPS connections between your computer and the Switch.

Note: If you see this warning page, it indicates that your browser has failed to verify the Secure Sockets Layer (SSL) certificate, which opens an encrypted connection. You can ignore this message and proceed to the login IP address.

Figure 30 Unsafe Login Warning

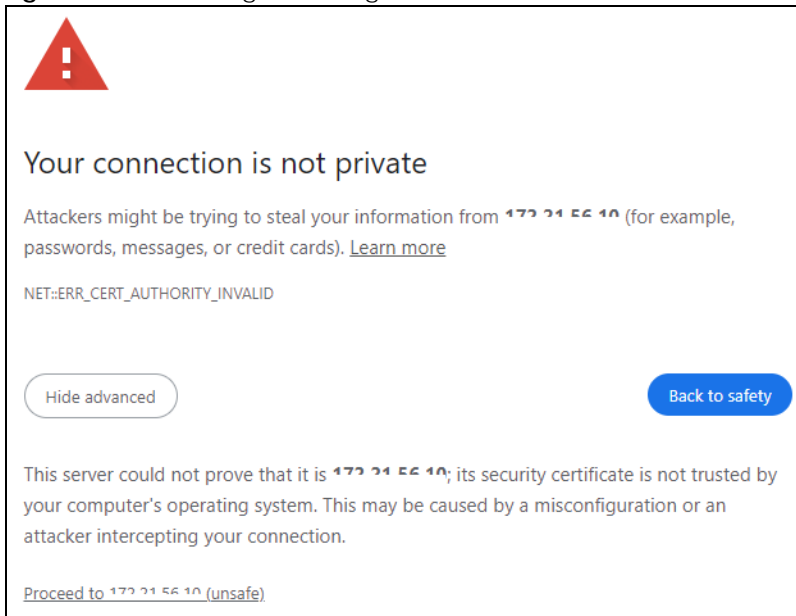

The **Login** screen appears.

Figure 31 Web Configurator: Login (Standalone mode)

GS1350-26HP

Enter User Name/Password and click Login.

admin

.....

Login

Manage Your Network with the Freedom of Cloud.

Visit Nebula

nebul

Figure 32 Web Configurator: Login (Cloud Mode)

GS1350-26HP

The Switch is being managed by Nebula.
Please use [the local credential password on NCC](#) to login.

User Name

Password

Login

Warning: Change configuration may cause inconsistency between local Web GUI & NCC.

Visit Nebula for Your Network Management.

Go Now

nebul

- In Standalone mode, click the **Visit Nebula** button if you want to open the Zyxel Nebula Control Center (NCC) login page in a new tab or window. In Cloud mode, click the **Go Now** button. The NCC is a cloud-based network management system that allows you to remotely manage and monitor the Switch. See [Section 1.1.2 on page 23](#) for information on changing your Switch to Nebula Cloud management.

Figure 33 Visit Nebula

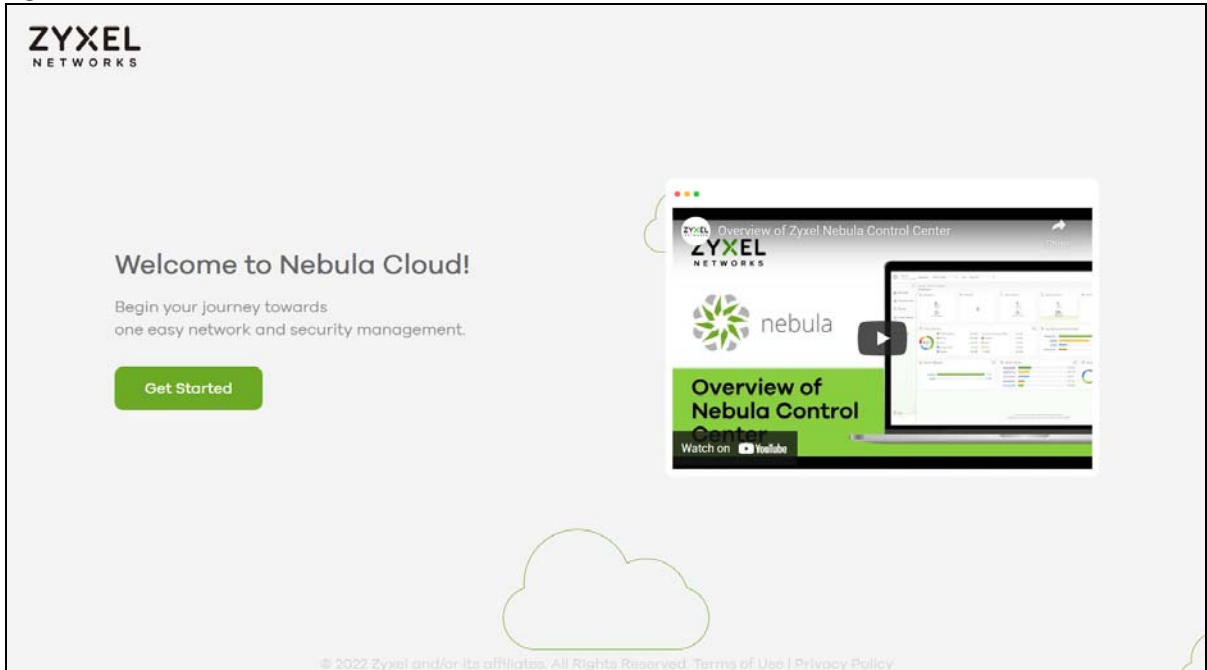

- 5 Alternatively, click **Login** to log into the Web Configurator to manage the Switch directly. In Standalone mode, the default user name is **admin** and associated default password is **1234**. In Cloud mode, use the **Local credentials: password** to login. The **Local credentials: Password** can be found in **Site-wide > Configure > Site settings > Device configuration** in the NCC portal. See the NCC User's Guide for more information.

In Standalone mode, the change password screen appears the first time you log in using the default password.

Note: The allowed string length is 1 to 32 for the new password and should not contain [?], [|], ['], ["], [,] or [space].

Figure 34 Change Password Screen (Standalone Mode)

- 6 After setting the new password, close and restart your web browser. Enter the 'https://DHCP-assigned IP' in the URL field and press [ENTER]. When the login screen appears, enter the user name (default: 'admin') and new password.

Figure 35 Password Changed Screen (Standalone Mode)

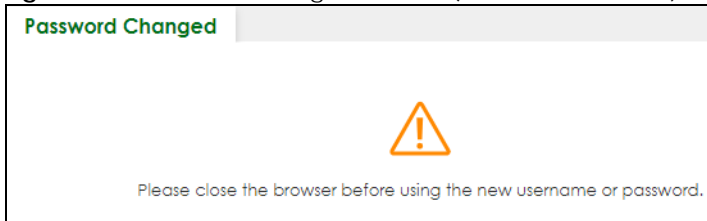

When in Standalone mode, the **Select Mode** screen appears.

Figure 36 Select Mode

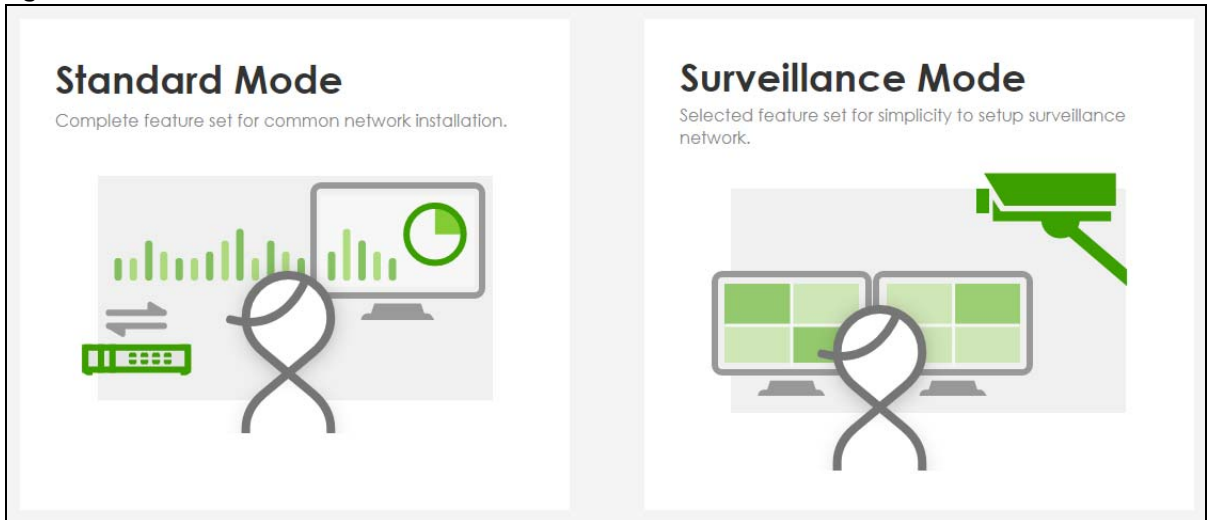

- 7 Select the Web Configurator in **Standard Mode** that has a complete set of configuration for network installation. Or select the Web Configurator in **Surveillance Mode** that has a set of menus specifically designed for users who are mostly using the Switch for configuring and managing PoE devices like IP cameras.
- 8 In Standalone mode, the **Setup Wizard** screen will appear after selecting the mode. You can use the **Setup Wizard** screen to configure the Switch's IP, login password, SNMP community, link aggregation, and so on. See [Section 4.4 on page 60](#) for more information on the **Setup Wizard** screen. When you finish configuring the settings, you can click the **Apply & Save** button to make the settings take effect, and save your configuration into the Switch's non-volatile memory at once. Check the screens to see if the settings are applied.

Once you click the **Finish** button, the settings configured in the **Setup Wizard** screen will overwrite the existing settings.

Otherwise, click the **Exit** button. You can select the **Ignore this wizard next time** checkbox and click **Apply & Save** if you do not want the **Setup Wizard** screen to appear the next time you log in. If you want to open the **Setup Wizard** screen later, click the **Wizard** icon in the upper right hand corner of the Web Configurator.

Figure 37 Web Configurator: Wizard

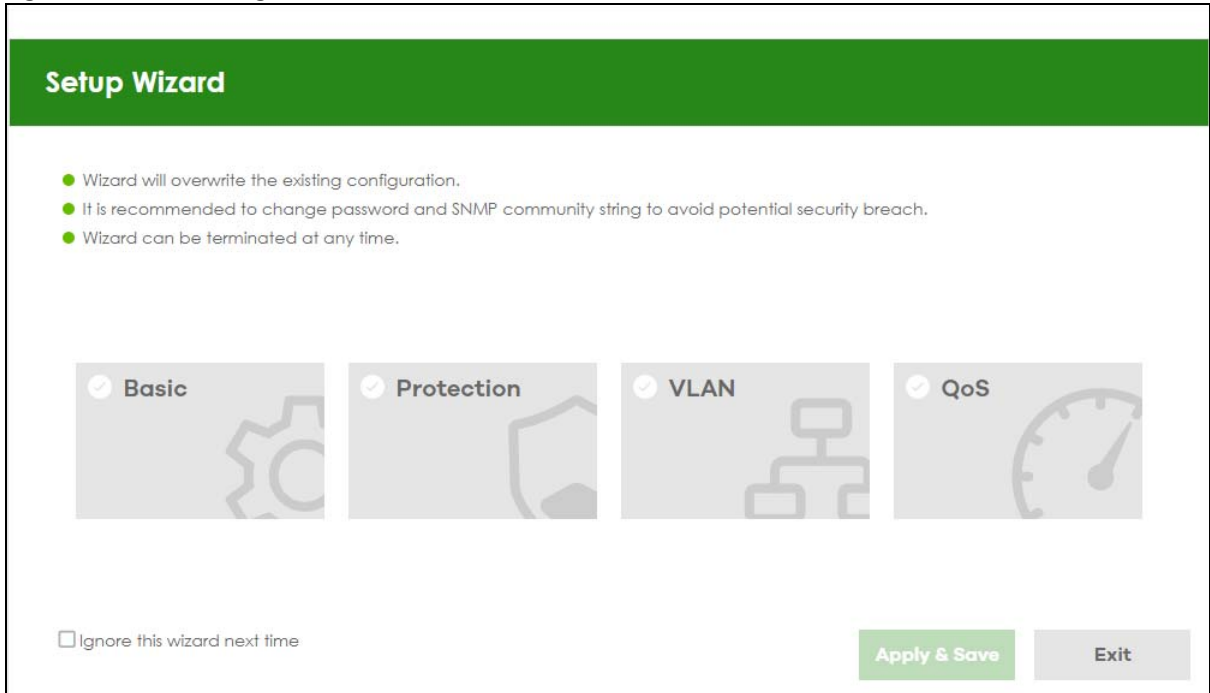

- 9 If you did not change the default SNMP community values and enabled **SNMP** in **SECURITY > Access Control > Service Access Control**, a warning screen displays each time you log into the Web Configurator. Click **SNMP** to open a screen where you can change the SNMP community string, see [Section 24.2 on page 148](#) for more information. Otherwise, click **Ignore** to close it.

SNMP Setting

Figure 38 Web Configurator: Warning

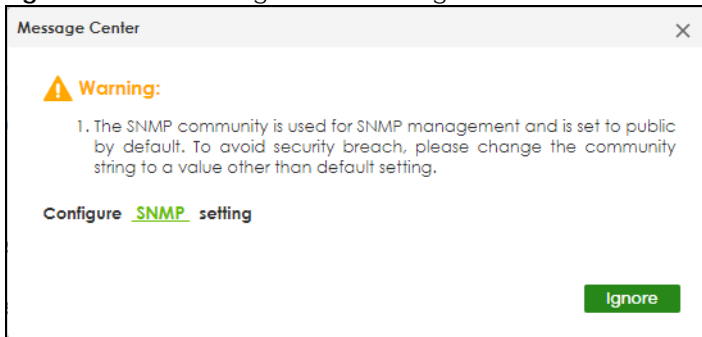

Figure 39 SYSTEM > SNMP

SNMP SNMP User SNMP Trap Group SNMP Trap Port

General Setting

Version: v2c ▾

Get Community: public

Set Community: public

Trap Community: public

Trap Destination

Index	Version	IP	Port	Username
1	v2c ▾	0.0.0.0	162	
2	v2c ▾	0.0.0.0	162	
3	v2c ▾	0.0.0.0	162	
4	v2c ▾	0.0.0.0	162	

Apply Cancel

4.3 Zyxel One Network (ZON) Utility

ZON Utility is a program designed to help you deploy and manage a network more efficiently. It detects devices automatically and allows you to do basic settings on devices in the network without having to be near it.

The ZON Utility issues requests through Zyxel Discovery Protocol (ZDP) and in response to the query, the device responds back with basic information including IP address, firmware version, location, system and model name in the same broadcast domain. The information is then displayed in the ZON Utility screen and you can perform tasks like basic configuration of the devices and batch firmware upgrade in it. You can download the ZON Utility at <https://www.zyxel.com/global/en/form/zon-utility-download> and unzip it first before installing it in a computer (Windows operating system).

4.3.1 Requirements

Before installing the ZON Utility in your computer, please make sure it meets the requirements listed below.

Operating System

At the time of writing, the ZON Utility is compatible with:

- Windows 7 (both 32-bit / 64-bit versions)
- Windows 8 (both 32-bit / 64-bit versions)
- Windows 8.1 (both 32-bit / 64-bit versions)

- Windows 10 (both 32-bit / 64-bit versions)
- Windows 11 (64-bit versions)

Hardware

Here are the minimum hardware requirements to use the ZON Utility on your computer.

- Core i3 processor
- 2 GB RAM
- 100 MB free hard disk
- WXGA (Wide XGA 1280 by 800)

4.3.2 Run the ZON Utility

- 1 Double-click the ZON Utility to run it.
- 2 Select a network adapter to which your supported devices are connected.

Figure 40 Network Adapter

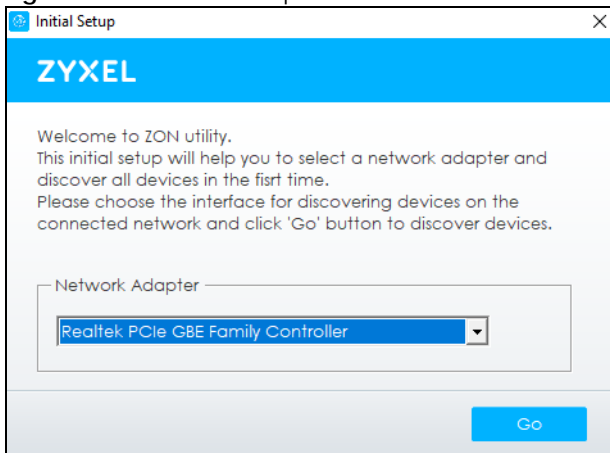

- 3 Click the **Go** button for the ZON Utility to discover all supported devices in your network.

Figure 41 Discovery

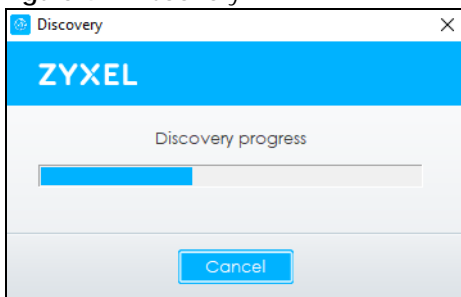

- 4 The ZON Utility screen shows the devices discovered.

Figure 42 ZON Utility Screen

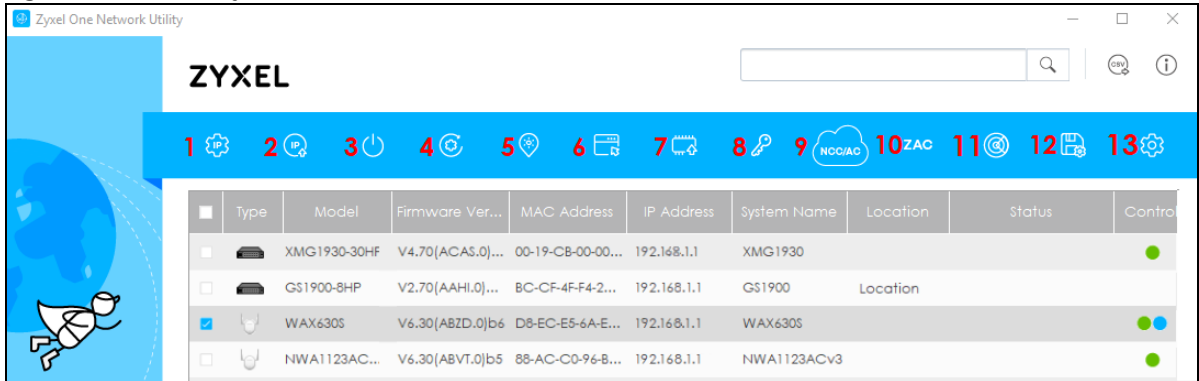

- 5 Select a device and then use the icons to perform actions. Some functions may not be available for your devices.

Note: You must know the selected device admin password before taking actions on the device using the ZON Utility icons.

Figure 43 Password Prompt

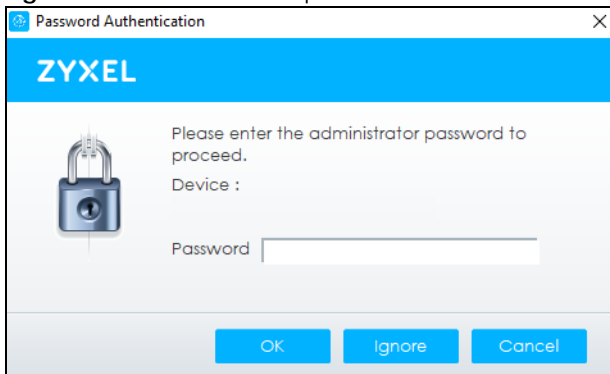

The following table describes the icons numbered from left to right in the ZON Utility screen.

Table 8 ZON Utility Icons

ICON	DESCRIPTION
1 IP Configuration	Change the selected device's IP address.
2 Renew IP Address	Update a DHCP-assigned dynamic IP address.
3 Reboot Device	Use this icon to restart the selected devices. This may be useful when troubleshooting or upgrading new firmware.
4 Reset Configuration to Default	Use this icon to reload the factory-default configuration file. This means that you will lose all previous configurations.
5 Locator LED	Use this icon to locate the selected device by causing its Locator LED to blink.
6 Web GUI	Use this to access the selected device Web Configurator from your browser. You will need a user name and password to log in.
7 Firmware Upgrade	Use this icon to upgrade new firmware to selected devices of the same model. Make sure you have downloaded the firmware from the Zyxel website to your computer and unzipped it in advance.
8 Change Password	Use this icon to change the admin password of the selected device. You must know the current admin password before changing to a new one.

Table 8 ZON Utility Icons (continued)

ICON	DESCRIPTION
9 Configure NCC Discovery	You must have Internet access to use this feature. Use this icon to enable or disable the Nebula Control Center (NCC) discovery feature on the selected device. If it is enabled, the selected device will try to connect to the NCC. Once the selected device is connected to and has registered in the NCC, it will go into the Nebula cloud management mode.
10 ZAC	Use this icon to run the Zyxel AP Configurator of the selected AP.
11 Clear and Rescan	Use this icon to clear the list and discover all devices on the connected network again.
12 Save Configuration	Use this icon to save configuration changes to permanent memory on a selected device.
13 Settings	Use this icon to select a network adapter for the computer on which the ZON utility is installed, and the utility language.

The following table describes the fields in the ZON Utility main screen.

Table 9 ZON Utility Fields

LABEL	DESCRIPTION
Type	This field displays an icon of the kind of device discovered.
Model	This field displays the model name of the discovered device.
Firmware Version	This field displays the firmware version of the discovered device.
MAC Address	This field displays the MAC address of the discovered device.
IP Address	This field displays the IP address of an internal interface on the discovered device that first received a ZDP discovery request from the ZON Utility.
System Name	This field displays the system name of the discovered device.
Location	This field displays where the discovered device is.
Status	This field displays whether changes to the discovered device have been done successfully. As the Switch does not support IP Configuration , Renew IP address and Flash Locator LED , this field displays "Update failed", "Not support Renew IP address" and "Not support Flash Locator LED" respectively.
Controller Discovery	This field displays if the discovered device supports the Nebula Control Center (NCC) discovery feature. If it is enabled, the selected device will try to connect to the NCC. Once the selected device is connected to and has registered in the NCC, it will go into the Nebula cloud management mode.
Serial Number	Enter the admin password of the discovered device to display its serial number.
Hardware Version	This field displays the hardware version of the discovered device.
IPv6 Address	This field displays the IPv6 address on the discovered device that first received a ZDP discovery request from the ZON Utility.

If you want to check the supported models and firmware versions, you can click the **Show information about ZON** icon in the upper right of the screen. Then select the **Supported model and firmware version** link. If your device is not listed here, see the device release notes for ZON Utility support. The release notes are in the firmware zip file on the Zyxel web site.

Figure 44 ZON Utility Screen

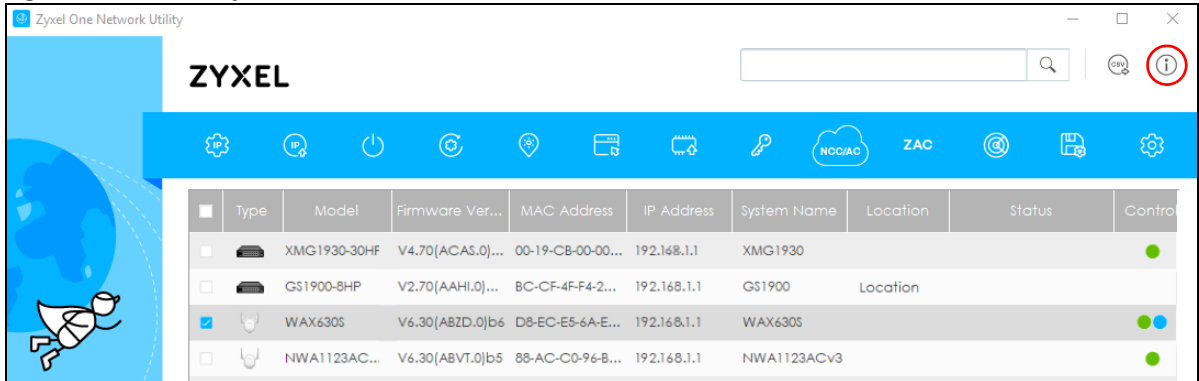

4.4 Wizard

The **Setup Wizard** contains the following parts:

- **Basic** – to configure the Switch IP address, DNS server, system password, SNMP community and link aggregation (trunking).
- **Protection** – to enable loop guard and broadcast storm control on the Switch and its ports.
- **VLAN** – to create a static VLAN, assign ports to the VLAN and set the ports to tag or untag outgoing frames.
- **QoS** – to determine a port's IEEE 802.1p priority level for QoS.

Note: When in Cloud mode, do NOT use the Wizard to configure the Switch.

Figure 45 Setup Wizard

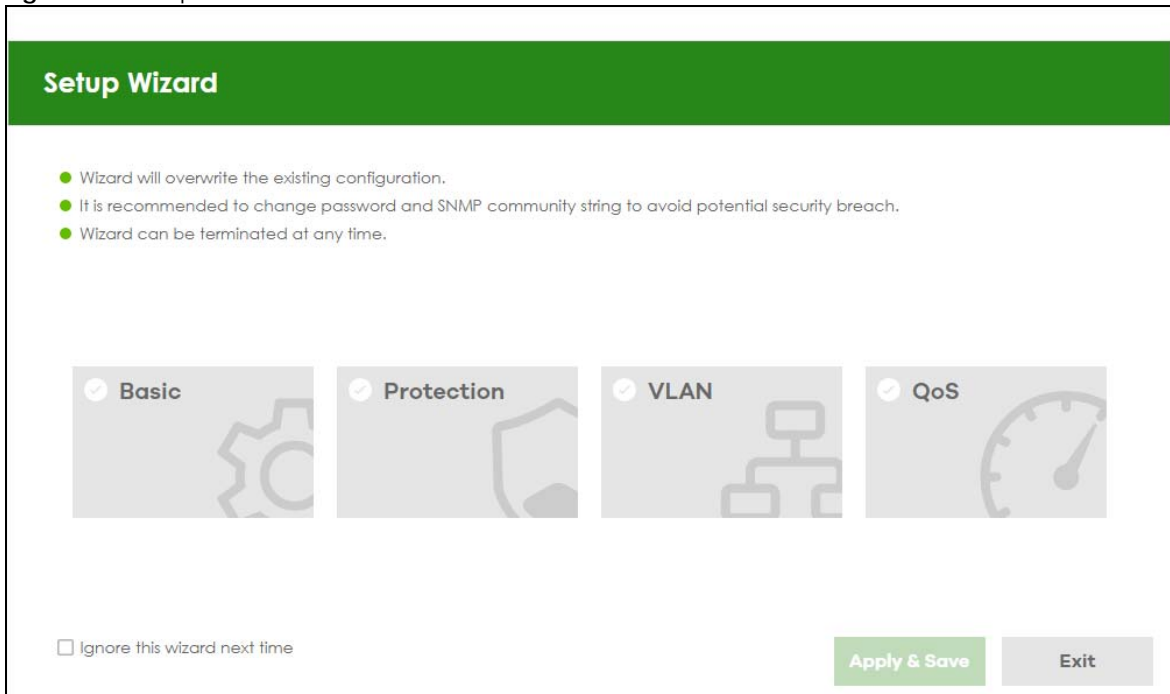

4.4.1 Basic

In **Basic**, you can set up IP/DNS, set up your password, SNMP community, link aggregation, and view finished results.

In order to set up your IP/DNS, please do the following. Click **Wizard > Basic > Step 1 IP** to access this screen.

Figure 46 Wizard > Basic > Step 1 IP

The screenshot shows the 'Setup IP' configuration screen. At the top, there is a green progress bar with four steps: 1 IP (selected), 2 Password, 3 Link Aggregation, and 4 Summary. Below the progress bar, the 'Setup IP' section contains several input fields: Host Name (GS1350), IP Interface (Static IP Address and DHCP Client), VID (1), IP Address (172.21.56.10), IP Subnet Mask (255.255.252.0), Default Gateway (172.21.59.254), and DNS Server (172.21.10.1). At the bottom right, there are 'Next' and 'Cancel' buttons.

Each field is described in the following table.

Table 10 Wizard > Basic > Step 1 IP

LABEL	DESCRIPTION
Host Name	This field displays a host name. Enter a string to set a new host name. The host name should not contain [?], [], ['], ["], or [,].
IP Interface	Select DHCP Client if the Switch is connected to a router with the DHCP server enabled. You then need to check the router for the IP address assigned to the Switch in order to access the Switch's Web Configurator again. Select Static IP Address when the Switch is NOT connected to a router or you want to assign it a fixed IP address.
VID	This field displays the VLAN ID.
IP Address	The Switch needs an IP address for it to be managed over the network.
IP Subnet Mask	The subnet mask specifies the network number portion of an IP address.
Default Gateway	Type the IP address of the default outgoing gateway in dotted decimal notation, for example 192.168.1.254.
DNS Server	DNS (Domain Name System) is for mapping a domain name to its corresponding IP address and so forth. Enter a domain name server IP address in order to be able to use a domain name instead of an IP address.

Table 10 Wizard > Basic > Step 1 IP

LABEL	DESCRIPTION
Next	Click Next to show the next screen.
Cancel	Click Cancel to exit this screen without saving.

After clicking **Next**, the **Password** screen appears.

Figure 47 Wizard > Basic > Step 2 Password

Note: The input string of any field in this screen should not contain [?], [|], ['], ["], or [,]. In the **Password** fields, [space] is also not allowed.

Each field is described in the following table.

Table 11 Wizard > Basic > Step 2 Password

LABEL	DESCRIPTION
Administrator's Password	
Current password	Type the existing system password (1234 is the default password when shipped).
New password	Enter your new system password. Up to 32 printable ASCII characters are allowed for the new password.
Confirm password	Retype your new system password for confirmation.
SNMP	
SNMP	Select Enabled to let the Switch act as an SNMP agent, which allows a manager station to manage and monitor the Switch through the network. Select Disabled to turn this feature off.

Table 11 Wizard > Basic > Step 2 Password (continued)

LABEL	DESCRIPTION
Version	Select the SNMP version for the Switch. The SNMP version on the Switch must match the version on the SNMP manager. Choose SNMP version 2c (v2c), SNMP version 3 (v3) or both (v3v2c). Note: SNMP version 2c is backwards compatible with SNMP version 1.
Get Community	Enter the Get Community string, which is the password for the incoming Get- and GetNextrequests from the management station. The Get Community string is only used by SNMP managers using SNMP version 2c or lower.
Set Community	Enter the Set Community string, which is the password for the incoming Set- requests from the management station. The Set Community string is only used by SNMP managers using SNMP version 2c or lower.
Trap Community	Enter the Trap Community string, which is the password sent with each trap to the SNMP manager. The Trap Community string is only used by SNMP managers using SNMP version 2c or lower.
Previous	Click Previous to show the previous screen.
Next	Click Next to show the next screen.
Cancel	Click Cancel to exit this screen without saving.

After clicking **Next**, the **Link Aggregation** screen appears.

Figure 48 Wizard > Basic > Step 3 Link Aggregation

The screenshot displays the 'Link Aggregation' configuration screen. At the top, a green progress bar indicates the current step is '3 Link Aggregation'. Below the progress bar, the screen is titled 'Link Aggregation'. On the left side, there is a grid of 26 ports, each represented by a green icon and a label (port1 through port26). A legend at the bottom indicates that a green icon represents 'Unselected' and a green square represents 'Selected'. In the center, there is a dropdown menu set to 'T1' and two arrows (right and left) for moving ports. On the right side, there are five columns labeled T1 through T5, each with a 'Static' dropdown menu. At the bottom, there are three buttons: 'Previous', 'Next', and 'Cancel'.

Each field is described in the following table.

Table 12 Wizard > Basic > Step 3 Link Aggregation

LABEL	DESCRIPTION
Link Aggregation	
T1-Tx	Click the arrows to add or delete icons located on the left to desired preference. Select Static if the ports are configured as static members of a trunk group. Select LACP if the ports are configured to join a trunk group through LACP.
Previous	Click Previous to show the previous screen.
Next	Click Next to show the next screen.
Cancel	Click Cancel to exit this screen without saving.

After clicking **Next**, the **Summary** screen appears.

Figure 49 Wizard > Basic > Step 4 Summary

Each field is described in the following table.

Table 13 Wizard > Basic > Step 4 Summary

LABEL	DESCRIPTION
Setup IP	
Host Name	This field displays a host name.
IP Interface	This field displays whether the WAN interface is using a DHCP IP address or a static IP address.
VID	This field displays the VLAN ID.
IP Address	The Switch needs an IP address for it to be managed over the network.
IP Subnet Mask	The subnet mask specifies the network number portion of an IP address.

Table 13 Wizard > Basic > Step 4 Summary (continued)

LABEL	DESCRIPTION
Default Gateway	Type the IP address of the default outgoing gateway in dotted decimal notation, for example 192.168.1.254.
DNS Server	DNS (Domain Name System) is for mapping a domain name to its corresponding IP address and vice versa. Enter a domain name server IP address in order to be able to use a domain name instead of an IP address.
Change administrator's password and activate SNMP	
New Password	This field displays asterisks when a new password has been created.
SNMP	This field displays whether the Switch acts as an SNMP agent.
Version	This field displays the SNMP version for the Switch.
Get Community	This field displays the Get Community string.
Set Community	This field displays the Set Community string.
Trap Community	This field displays the Trap Community string.
Link Aggregation	
Group	This field displays the group number.
Type	This field displays Static or LACP of this group.
Member	This field displays the members of this group.
Previous	Click Previous to show the previous screen.
Finish	Review the information and click Finish to create the task.
Cancel	Click Cancel to exit this screen without saving.

4.4.2 Protection

In **Protection**, you can set up loop guard and broadcast storm control.

In order to set up loop guard, please do the following. Click **Wizard > Protection > Step 1 Loop Guard** to access this screen.

Figure 50 Wizard > Protection > Step 1 Loop Guard

Each field is described in the following table.

Table 14 Wizard > Protection > Step 1 Loop Guard

LABEL	DESCRIPTION
Loop Guard	
Select all ports	Select all ports to enable the loop guard feature on all ports. You can select a port by clicking it.
Next	Click Next to show the next screen.
Cancel	Click Cancel to exit this screen without saving.

After clicking **Next**, the **Broadcast Storm Control** screen appears.

Figure 51 Wizard > Protection > Step 2 Broadcast Storm Control

Each field is described in the following table.

Table 15 Wizard > Protection > Step 2 Broadcast Storm Control

LABEL	DESCRIPTION
Broadcast Storm Control	
Select all ports	Select all ports to apply settings on all ports. You can select a port by clicking it.
Broadcast pkt/s	Specify how many broadcast packets the port receives per second.
Previous	Click Previous to show the previous screen.
Next	Click Next to show the next screen.
Cancel	Click Cancel to exit this screen without saving.

After clicking **Next**, the **Summary** screen appears.

Figure 52 Wizard > Protection > Step 3 Summary

1 Loop Guard **2** Broadcast Storm Control **3** Summary
STEP

Summary

Loop Guard

2	4	6	8	10	12	14	16	18	20	22	24	26
<input type="checkbox"/>	<input type="checkbox"/>	<input type="checkbox"/>	<input type="checkbox"/>	<input type="checkbox"/>	<input type="checkbox"/>	<input type="checkbox"/>	<input type="checkbox"/>	<input type="checkbox"/>	<input type="checkbox"/>	<input type="checkbox"/>	<input type="checkbox"/>	<input type="checkbox"/>
1	3	5	7	9	11	13	15	17	19	21	23	25

Unselected Selected

Broadcast Storm Control

2	4	6	8	10	12	14	16	18	20	22	24	26
<input checked="" type="checkbox"/>	<input checked="" type="checkbox"/>	<input checked="" type="checkbox"/>	<input checked="" type="checkbox"/>	<input checked="" type="checkbox"/>	<input checked="" type="checkbox"/>	<input checked="" type="checkbox"/>	<input checked="" type="checkbox"/>	<input checked="" type="checkbox"/>	<input checked="" type="checkbox"/>	<input checked="" type="checkbox"/>	<input checked="" type="checkbox"/>	<input checked="" type="checkbox"/>
1000	1000	1000	1000	1000	1000	1000	1000	1000	1000	1000	1000	1000
1	3	5	7	9	11	13	15	17	19	21	23	25
1000	1000	1000	1000	1000	1000	1000	1000	1000	1000	1000	1000	1000

Unselected Selected

Previous **Finish** Cancel

Each field is described in the following table.

Table 16 Wizard > Protection > Step 3 Summary

LABEL	DESCRIPTION
Summary	
Loop Guard	If the loop guard feature is enabled on a port, the Switch will prevent loops on this port.
Broadcast Storm Control	If the broadcast storm control feature is enabled on a port, the number of broadcast packets the Switch receives per second will be limited on this port.
Previous	Click Previous to show the previous screen.
Finish	Review the information and click Finish to create the task.
Cancel	Click Cancel to exit this screen without saving.

4.4.3 VLAN

In **VLAN**, you can create VLAN, and tag VLAN settings.

Click **Wizard > VLAN > VLAN Setting** to access this screen.

Figure 53 Wizard > VLAN > VLAN Setting

Each field is described in the following table.

Table 17 Wizard > VLAN > VLAN Setting

LABEL	DESCRIPTION
VLAN Setting	
Default VLAN 1 / Access Untagged port	After you create a VLAN and select the VLAN ID from the drop-down list box, select ports and use the right arrow to add them as the untagged ports to a VLAN group.
VLAN member port	
VLAN	Type a number between 2 and 4094 to create a VLAN.
Trunk Tagged port	Select ports and use the downward arrow to add them as the tagged ports to the VLAN groups you created.
Finish	Review the information and click Finish to create the task.
Cancel	Click Cancel to exit this screen without saving.

4.4.4 QoS

In **QoS**, you can create QoS settings.

In order to create QoS settings, please do the following. Click **Wizard > QoS > QoS Setting** to access this screen.

Figure 54 Wizard > QoS > QoS Setting

Each field is described in the following table.

Table 18 Wizard > QoS > QoS Setting

LABEL	DESCRIPTION
QoS Setting	
Select all ports	Select all ports to apply settings on all ports. You can select a port by clicking it.
High	Select ports and click the High button, so they will have high priority. The port's IEEE 802.1p priority level will be set to 5. Use the PORT > Port Setup screen to adjust the value.
Medium	Select ports and click the Medium button and, so they will have medium priority. The port's IEEE 802.1p priority level will be set to 3. Use the PORT > Port Setup screen to adjust the value.
Low	Select ports and click the Low button, so they will have low priority. The port's IEEE 802.1p priority level will be set to 1. Use the PORT > Port Setup screen to adjust the value.
Finish	Review the information and click Finish to create the task.
Cancel	Click Cancel to exit this screen without saving.

4.5 Web Configurator Layout

The **DASHBOARD** screen is the first screen that displays when you access the Web Configurator.

This guide uses GS1350-26HP screens as an example. The screens may vary slightly for different models.

The following figure shows the navigating components of a Web Configurator screen.

Figure 55 Web Configurator Layout (Standalone Mode)

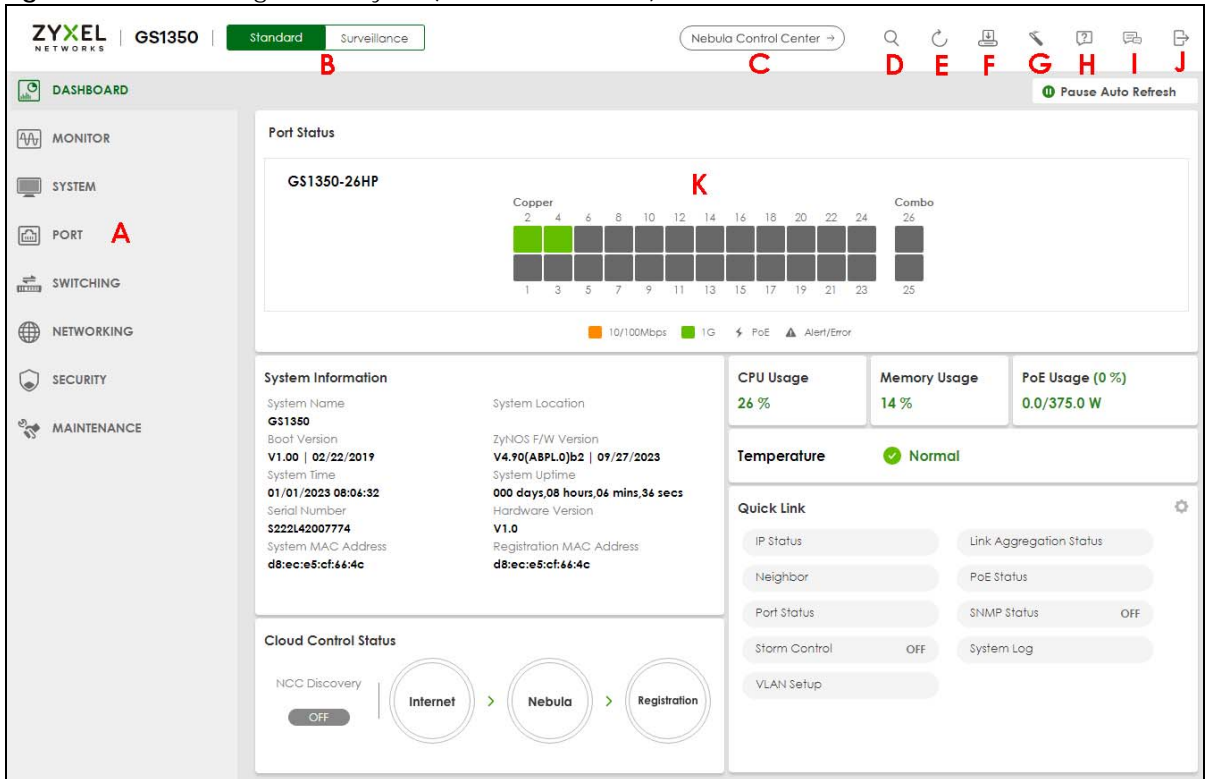
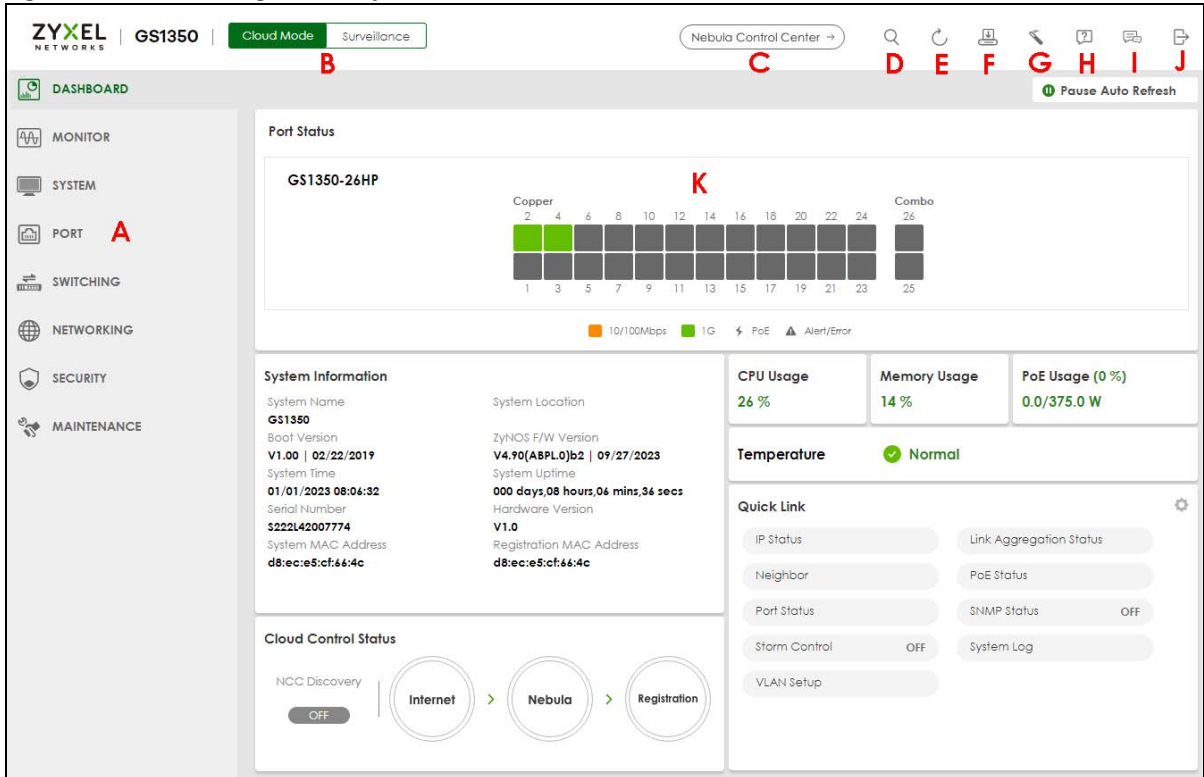

Figure 56 Web Configurator Layout (Cloud Mode)



A – Click the menu items to open sub-menu links, and then click on a sub-menu link to open the screen in the main window.

B, C, D, E, F, G, H, I, J, K – These are quick links which allow you to perform certain tasks no matter which screen you are currently working in.

B – In Standalone mode, click this icon to switch between the Web Configurator’s **Standard** or **Surveillance** mode.

In Cloud mode, click this icon to switch between the Web Configurator’s **Cloud** or **Surveillance** mode.

C – Click this icon to go to the NCC (Nebula Control Center) portal website.

D – Click this icon to search for specific configurations or status you are looking for. Enter the keywords and click the result link. This will direct you to the specific configuration or status page.

E – Click this icon to update the information in the screen you are currently viewing.

F – Click this icon to save your configuration into the Switch’s non-volatile memory. Non-volatile memory is the configuration of your Switch that stays the same even if the Switch’s power is turned off.

G – Click this icon to display the **Setup Wizard** that contains the **Basic, Protection, VLAN, and QoS** setup screens.

H – Click this icon to display web help pages. The help pages provide descriptions for all of the configuration screens.

I – Click this icon to go to the Zyxel Community Biz Forum.

J – Click this icon to log out of the Web Configurator.

K – This displays the Nebula Cloud Control Status. The ON/OFF switch displays if **NCC Discovery** is enabled. If a status circle turns Orange, it means the Switch is unable to connect to NCC. Hover the mouse over the status circle to check the diagnostic message. You can also click the ON/OFF switch to go to the **SYSTEM > Cloud Management** screen and check the diagnostic messages. See [Section Table 34 on page 120](#) for more information.

In the navigation panel, click a main link to reveal a list of sub-menu links.

The following table describes the links in the navigation panel. The navigation panel varies depending on the product model you use.

Table 19 Navigation Panel Links

LINK	DESCRIPTION
DASHBOARD	This link takes you to the main dashboard screen that displays general system and device information.
MONITOR	
ARP Table	This link takes you to a screen that displays the current ARP table of the Switch. You can view the IP and MAC address mapping, VLAN ID, ARP aging time, and ARP entry type of a device attached to a port.
IPv6 Neighbor Table	This link takes you to a screen where you can view the Switch's IPv6 neighbor table.
MAC Table	This link takes you to a screen where you can view the MAC address and VLAN ID of a device attach to a port. You can also view what kind of MAC address it is.
Neighbor	This link takes you to a screen where you can view neighbor devices (including non-Zyxel devices) connected to the Switch.
Path MTU Table	This link takes you to a screen where you can view the IPv6 path MTU information on the Switch.
Port Status	This link takes you to a screen where you can view the port statistics.
System Information	This link takes you to a screen that displays general system information.
System Log	This link takes you to a screen where you can view the system log including fail log and system status.
SYSTEM	
Cloud Management	This link takes you to a screen where you can enable or disable the Nebula Control Center (NCC) Discovery feature and view the NCC connection status. If Nebula Control Center (NCC) Discovery is enabled, you can have the Switch search for the NCC (Nebula Control Center). The screen also displays a QR code containing the Switch's serial number and MAC address for handy registration of the Switch at NCC.
General Setup	This link takes you to a screen where you can configure general identification information about the Switch.
Interface Setup	This link takes you to a screen where you can configure settings for individual interface type and ID.
IP Setup	This link takes you to a screen where you can configure the DHCP client, and a static IP address (IP address and subnet mask).
IPv6	Click the link to unfold the following sub-link menu.
IPv6 Status	This link takes you to a screen where you can view the IPv6 table and DNS server.
IPv6 Global Setup	This link takes you to a screen where you can configure the global IPv6 settings.
IPv6 Interface Setup	This link takes you to a screen where you can view and configure IPv6 interfaces.

Table 19 Navigation Panel Links (continued)

LINK	DESCRIPTION
IPv6 Addressing	This link takes you to a screen where you can view and configure IPv6 link-local and global addresses.
IPv6 Neighbor Discovery	This link takes you to a screen where you can view and configure neighbor discovery settings on each interface.
IPv6 Neighbor Setup	configure static IPv6 neighbor entries in the Switch's IPv6 neighbor table.
DHCPv6 Client Setup	This link takes you to a screen where you can configure the Switch's DHCP settings when it is acting as a DHCPv6 client.
Logins	This link takes you to a screen where you can change the system login password, as well as configure up to four login details.
SNMP	This link takes you to screens where you can specify the SNMP version and community (password) values, configure where to send SNMP traps from the Switch, enable loopguard/errdisable/poe/linkup/linkdown/lldp/transceiver-ddm/storm-control on the Switch, specify the types of SNMP traps that should be sent to each SNMP manager, and add/edit user information.
Switch Setup	This link takes you to a screen where you can set up global Switch parameters such as VLAN type.
Syslog Setup	This link takes you to a screen where you can configure the Switch's system logging settings and configure a list of external syslog servers.
Time Range	This link takes you to a screen where you can configure time range for time-oriented features like Classifier.
PORT	
Auto PD Recovery	This link takes you to a screen where you can enable and configure Auto PD Recovery on the Switch.
Green Ethernet	This link takes you to a screen where you can configure the Switch to reduce port power consumption.
Link Aggregation	This link takes you to a screen where you can logically aggregate physical links to form one logical, higher-bandwidth link.
LLDP	Click the link to unfold the following sub-link menu.
LLDP	This link takes you to screens where you can view LLDP information and configure LLDP and TLV settings.
LLDP MED	This link takes you to screens where you can configure LLDP-MED parameters.
PoE Setup	For PoE models. This link takes you to a screen where you can set priorities, PoE power-up settings and schedule so that the Switch is able to reserve and allocate power to certain PDs.
Port Setup	This link takes you to a screen where you can configure settings for individual Switch ports.
SWITCHING	
Loop Guard	This link takes you to a screen where you can configure protection against network loops that occur on the edge of your network.
Mirroring	Click the link to unfold the following sub-link menu.
Mirroring	This link take you to a screen where you can copy traffic from one port or ports to another port in order to examine the traffic from the first port without interference.
Multicast	Click the link to unfold the following sub-link menu.
IPv4 Multicast	This link takes you to screen where you can configure various IPv4 multicast features, IGMP snooping, filtering and create multicast VLANs.
Static Multicast Forwarding By MAC	This link takes you to a screen where you can configure static multicast MAC addresses for port(s). These static multicast MAC addresses do not age out.
ONVIF	This link takes you to a screen where you can configure a specific VLAN to run ONVIF.
QoS	Click the link to unfold the following sub-link menu.

Table 19 Navigation Panel Links (continued)

LINK	DESCRIPTION
Diffserv	This link takes you to screens where you can enable DiffServ, configure marking rules and set DSCP-to-IEEE802.1p mappings.
Queuing Method	This link takes you to a screen where you can set priorities for the queues of the Switch. This distributes bandwidth across the different traffic queues.
Priority Queue	This link takes you to a screen where you can set priority tags for different traffic types and specify the priority levels.
Bandwidth Control	This link takes you to a screen where you can cap the maximum bandwidth allowed on a port.
Spanning Tree Protocol	Click the link to unfold the following sub-link menu.
Spanning Tree Protocol Status	This link takes you to a screen where you can view the STP status in the different STP modes (RSTP, MRSTP or MSTP) you can configure on the Switch.
Spanning Tree Setup	This link takes you to a screen where you can activate one of the STP modes (RSTP, MRSTP or MSTP) on the Switch.
RSTP	This link takes you to a screen where you can configure the RSTP (Rapid Spanning Tree Protocol) settings on the Switch.
MSTP	This link takes you to a screen where you can configure the MSTP (Multiple Spanning Tree Protocol) settings on the Switch.
Static MAC Filtering	This link takes you to a screen to set up static MAC filtering rules.
Static MAC Forwarding	This link takes you to a screen where you can configure static MAC addresses for a port. These static MAC addresses do not age out.
VLAN	Click the link to unfold the following sub-link menu.
VLAN Status	This link takes you to a screen where you can view and search all VLAN groups.
VLAN Setup	This link takes you to screens where you can: <ul style="list-style-type: none"> • configure port-based or 802.1Q VLAN. • view detailed port settings and status of the VLAN group. • configure and view 802.1Q VLAN parameters for the Switch. • configure the static VLAN settings on a port.
Voice VLAN Setup	This link takes you to a screen where you can set up VLANs that allow you to group voice traffic with defined priority and enable the Switch port to carry the voice traffic separately from data traffic to ensure the sound quality does NOT deteriorate.
MAC Based VLAN Setup	This link takes you to a screen where you can set up VLANs that allow you to group untagged packets into logical VLANs based on the source MAC address of the packet. This eliminates the need to reconfigure the Switch when you change ports. The Switch will forward the packets based on the source MAC address you set up previously.
Vendor ID Based VLAN Setup	This link takes you to screens where you can set up VLANs that allow you to group untagged packets into logical VLANs based on the source MAC address of the packet. You can specify a mask for the MAC address to create a MAC address filter and enter a weight to set the VLAN rule's priority.
NETWORKING	
ARP Setup	Click the link to unfold the following sub-link menu.
ARP Learning	This link takes you to a screen where you can configure ARP learning mode on a per-port basis.
DHCP	Click the link to unfold the following sub-link menu.
DHCPv4 Relay	This link takes you to screens where you can view DHCPv4 relay status, mode, and configure DHCPv4 relay settings.

Table 19 Navigation Panel Links (continued)

LINK	DESCRIPTION
DHCPv6 Relay	This link takes you to a screen where you can enable and configure DHCPv6 relay.
Static Routing	Click the link to unfold the following sub-link menu.
IPv4 Static Route	This link takes you to a screen where you can configure IPv4 static routes. A static route defines how the Switch should forward traffic by destination IP address and subnet mask.
SECURITY	
AAA	Click the link to unfold the following sub-link menu.
RADIUS Server Setup	This link takes you to a screen where you can configure your RADIUS (Remote Authentication Dial-In User Service) server settings for authentication.
AAA Setup	This link takes you to a screen where you can configure authentication, authorization and accounting services through external RADIUS servers.
Access Control	Click the link to unfold the following sub-link menu.
Service Access Control	This link takes you to a screen where you can decide what services you may use to access the Switch.
Remote Management	This link takes you to a screen where you can specify a group of one or more "trusted computers" from which an administrator may use a service to manage the Switch.
Account Security	This link takes you to a screen where you can configure account security settings on the Switch.
Storm Control	This link takes you to a screen to set up broadcast filters.
Errdisable	This link takes you to screens where you can view errdisable status and configure errdisable settings in CPU protection, errdisable detect, and errdisable recovery.
DHCP Snooping	This link takes you to screens where you can view DHCP snooping database details and configure DHCP snooping settings on ports or VLANs. You can use DHCP snooping to filter unauthorized DHCP packets on the network and to build the binding table dynamically.
Port Security	This link takes you to a screen where you can activate MAC address learning and set the maximum number of MAC addresses to learn on a port.
MAINTENANCE	
Certificates	The link takes you to a screen where you can import the Switch's CA-signed certificates.
Cluster Management	This link takes you to a screen where you can configure clustering management and view its status.
Configuration	Click the link to unfold the following sub-link menu.
Restore Configuration	This link takes you to a screen where you can upload a stored device configuration file.
Backup Configuration	This link takes you to a screen where you can save your Switch's configurations (settings) for later use.
Erase Running-Configuration	This link takes you to a screen where you can reset the configuration to the Zyxel default configuration settings.
Save Configuration	This link takes you to a screen where you can save the current configuration (settings) to a specific configuration file on the Switch.
Configure Clone	This link takes you to a screen where you can copy the basic and advanced settings from a source port to a destination port or ports.
Diagnostic	This link takes you to a screen where you can ping IP addresses, run traceroute, test ports and show the location of the Switch.

Table 19 Navigation Panel Links (continued)

LINK	DESCRIPTION
Firmware Upgrade	This link takes you to a screen to upload firmware to your Switch.
Reboot System	This link takes you to a screen to reboot the Switch without turning the power off.
SSH Authorized Keys	This link takes you to a screen where you can authenticate secure SSH connections between a client computer and the Switch (also called the server) without needing a password to connect to the Switch.
Tech-Support	This link takes you to a screen where you can download related log reports for issue analysis. Log reports include CPU history and utilization, crash and memory.

4.5.1 Tables and Lists

The Web Configurator tables and lists provide several options for how to work with their entries.

4.5.1.1 Working with Table Entries

Tables have tool icons for working with table entries as shown next. You can select one or more entries, or select the checkbox in the heading row to select all entries. Use the tool icons to modify the selected entries.

Figure 57 Working with a Table

<input type="checkbox"/>	Index	IP Address	IP Subnet Mask	VID	Type
<input type="checkbox"/>	1	192.168.3.115	255.255.255.0	1	Static
<input type="checkbox"/>	2	172.21.40.3	255.255.252.0	1	DHCP

The following table describes the most common table icons.

Table 20 Common Table Icons

LABEL	DESCRIPTION
	Select an entry's checkbox to select a specific entry. Otherwise, select the checkbox in the table heading row to select all entries.
Add/Edit	Click this to create a new entry or edit a selected entry. A configuration screen where you can add a new entry or modify the settings of the selected entry will open. In some configuration screens, the Add/Edit button is replaced by the Edit button. This means you can only edit the existing entries in the table.
Delete	To remove entries, select the entries and click Delete .

When viewing a list, you can click on an index number to view more details about the entry. If the list has more than one page, click the arrow button to navigate to different pages of entries.

Figure 58 Working on a List

The Number of VLAN: 13

◀ < Page 1 of 2 > ▶

Index	VID	Name	Tagged Port	Untagged Port	Elapsed Time	Status
1	1	1		1-28	19:35:49	Static
2	2	2			0:01:36	Static
3	3	3			0:01:30	Static
4	4	4			0:01:22	Static
5	8	8			0:00:57	Static
6	9	9			0:00:52	Static
7	10	10			0:00:45	Static
8	11	11			0:00:40	Static
9	12	12			0:00:34	Static
10	13	13			0:00:21	Static

◀ < Page 1 of 2 > ▶

4.5.2 Change Your Password

After you log in for the first time, it is recommended you change the default administrator password. See [Section 4.2 on page 50](#) for more information. Click **SYSTEM** > **Logins** to display the next screen.

Figure 59 Change Administrator Login Password

Logins

Administrator

User Name:

Old Password:

New Password:

Retype to confirm:

 Please record your new password whenever you change it. The system will lock you out if you have forgotten your password.

Edit Logins

Login	User Name	Password	Retype to confirm	Privilege
1	<input type="text"/>	<input type="password"/>	<input type="password"/>	<input type="text"/>
2	<input type="text"/>	<input type="password"/>	<input type="password"/>	<input type="text"/>
3	<input type="text"/>	<input type="password"/>	<input type="password"/>	<input type="text"/>
4	<input type="text"/>	<input type="password"/>	<input type="password"/>	<input type="text"/>

4.6 Save Your Configuration

When you are done modifying the settings in a screen, click **Apply** to save your changes back to the run-time memory. Settings in the run-time memory are lost when the Switch's power is turned off.

Click the **Save** link in the upper right of the Web Configurator to save your configuration to non-volatile memory. Non-volatile memory refers to the Switch's storage that remains even if the Switch's power is turned off.

Note: Use the **Save** link when you are done with a configuration session.

4.7 Switch Lockout

You could block yourself (and all others) from managing the Switch if you do one of the following:

- 1 Delete the management VLAN (default is VLAN 1).
- 2 Delete all port-based VLANs with the CPU port as a member. The "CPU port" is the management port of the Switch.
- 3 Filter all traffic to the CPU port.
- 4 Disable all ports.
- 5 Misconfigure the text configuration file.
- 6 Forget the password and/or IP address.
- 7 Prevent all services from accessing the Switch.
- 8 Change a service port number but forget it.
- 9 You forgot to log out of the Switch from a computer before logging in again on another computer.

Note: Be careful not to lock yourself and others out of the Switch.

4.8 Reset the Switch

If you lock yourself (and others) from the Switch or forget the administrator password, you will need to reload the factory-default configuration file or reset the Switch back to the factory defaults.

4.8.1 Restore Button

Press the **RESTORE** button for more than 7 seconds to have the Switch automatically reboot and restore the factory default file. See [Section 3.3 on page 46](#) for more information about the LED behavior.

4.8.2 Restore Custom Default (Standalone mode only)

Press the **RESTORE** button for 3 to 7 seconds to have the Switch automatically reboot and restore the last-saved custom default file. See [Section 3.3 on page 46](#) for more information about the LED behavior.

4.8.3 Reboot the Switch

Press the **RESET** button to reboot the Switch without turning the power off. See [Section 3.3 on page 46](#) for more information about the LED behavior.

4.9 Log Out of the Web Configurator

Click **Logout** in a screen to exit the Web Configurator. You have to log in with your password again after you log out. This is recommended after you finish a management session for security reasons.

Figure 60 Logout button



4.10 Help

The Web Configurator's online help has descriptions of individual screens and some supplementary information.

Click the **Help** icon on a Web Configurator screen to view an online help description (shown as below) of that screen.

Figure 61 Online Web Help

 A screenshot of the ZyXEL Network Center online help page. The page has a left sidebar with a navigation menu and a main content area. The main content area is titled "DASHBOARD" and contains a search bar, navigation icons, and a table with two columns: "LABEL" and "DESCRIPTION".

DASHBOARD	
LABEL	DESCRIPTION
Pause Auto Refresh	The DASHBOARD screen automatically refreshes every 30 seconds. Click this to disable the auto refresh. Click Resume Auto Refresh to enable.
Port Status	This displays individual port type, status, and connection speed of the Switch. Click on a port to open the port's status panel. Use the status panel to enable/disable a port and view its basic information. For example, link speed and port utilization. In Stacking mode, this displays the port status of the slot (Switch) selected in the SLOT field.

CHAPTER 5

Initial Setup Example

5.1 Overview

This chapter shows how to set up the Switch for an example network.

The following lists the configuration steps for the initial setup:

- [Create a VLAN](#)
- [Set Port VID](#)
- [Configure Switch Management IP Address](#)

5.1.1 Create a VLAN

VLANs confine broadcast frames to the VLAN group in which the ports belongs. You can do this with port-based VLAN or tagged static VLAN with fixed port members.

In this example, you want to configure port 1 as a member of VLAN 2.

Figure 62 Initial Setup Network Example: VLAN

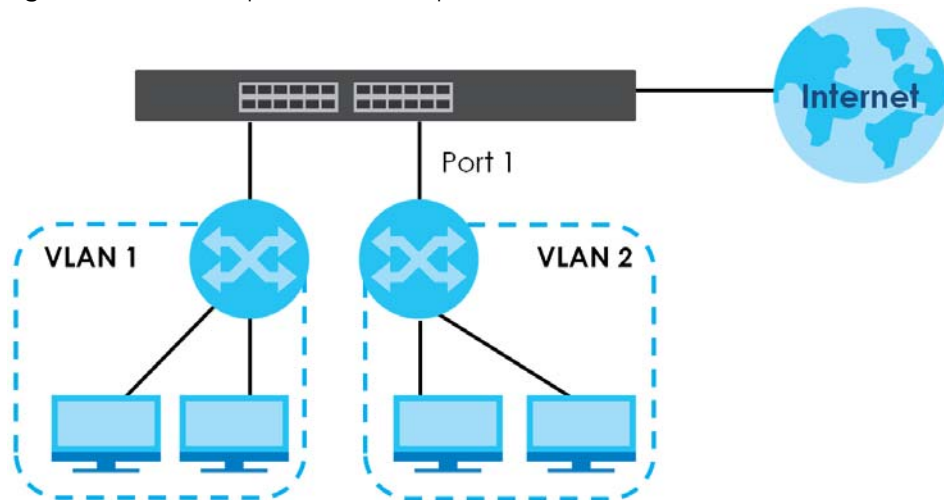

- 1 Go to the **SWITCHING > VLAN > VLAN Setup > Static VLAN** screen. Click **Add/Edit**.

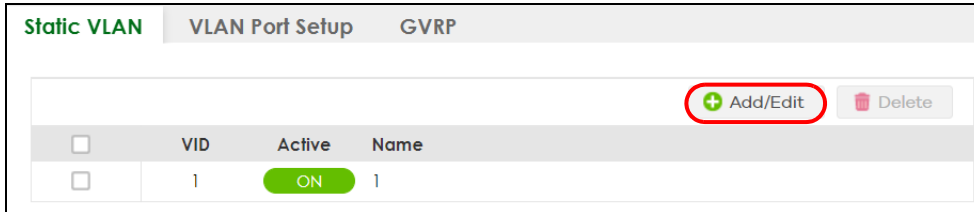

- The following screen appears. Click the switch to set this VLAN to **Active**, enter a descriptive name in the **Name** field and enter "2" in the **VLAN Group ID** field for the **VLAN2** network.

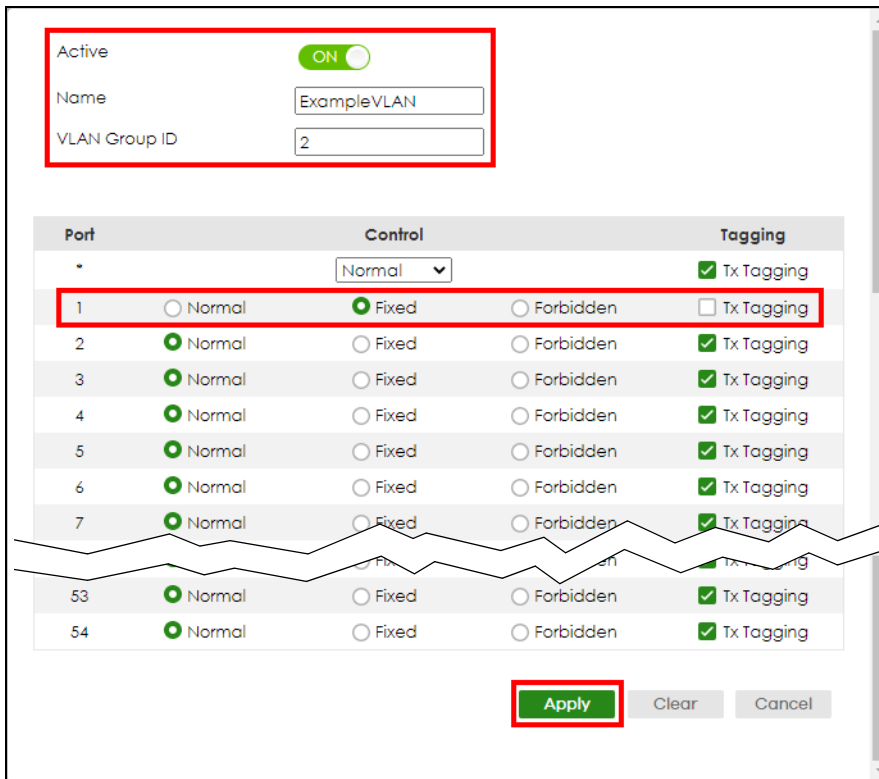

Note: The **VLAN Group ID** field in this screen and the **VID** field in the **SYSTEM > IP Setup > IP Status** screen refer to the same VLAN ID.

- Since the **VLAN2** network is connected to port 1 on the Switch, select **Fixed** to configure port 1 to be a permanent member of the VLAN only.
- To ensure that VLAN-unaware devices (such as computers and hubs) can receive frames properly, clear the **Tx Tagging** checkbox to set the Switch to remove VLAN tags before sending.
- Click **Apply** to save the settings to the run-time memory. Settings in the run-time memory are lost when the Switch's power is turned off.

5.1.2 Set Port VID

Use PVID to add a tag to incoming untagged frames received on that port so that the frames are forwarded to the VLAN group that the tag defines.

In the example network, configure 2 as the port VID on port 1 so that any untagged frames received on

that port get sent to VLAN 2.

Figure 63 Initial Setup Network Example: Port VID

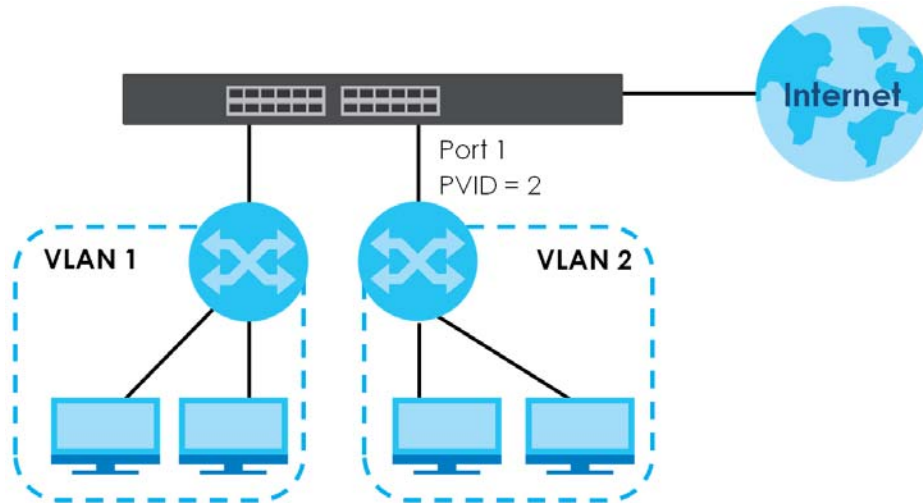

- 1 Go to the **SWITCHING > VLAN > VLAN Setup > VLAN Port Setup** screen.

Port	Ingress Check	PVID	Acceptable Frame Type	VLAN Trunking	Isolation
*	<input type="checkbox"/>		All	<input type="checkbox"/>	<input type="checkbox"/>
1	<input type="checkbox"/>	2	All	<input type="checkbox"/>	<input type="checkbox"/>
2	<input type="checkbox"/>	1	All	<input type="checkbox"/>	<input type="checkbox"/>
3	<input type="checkbox"/>	1	All	<input type="checkbox"/>	<input type="checkbox"/>
4	<input type="checkbox"/>	1	All	<input type="checkbox"/>	<input type="checkbox"/>
5	<input type="checkbox"/>	1	All	<input type="checkbox"/>	<input type="checkbox"/>
6	<input type="checkbox"/>	1	All	<input type="checkbox"/>	<input type="checkbox"/>
7	<input type="checkbox"/>	1	All	<input type="checkbox"/>	<input type="checkbox"/>

- 2 Enter 2 in the **PVID** field for port 1 and click **Apply** to save your changes back to the run-time memory. Settings in the run-time memory are lost when the Switch's power is turned off.

5.1.3 Configure Switch Management IP Address

If the Switch fails to obtain an IP address from a DHCP server, the Switch will use 192.168.1.1 as the management IP address. You can configure another IP address in a different subnet for management purposes. The following figure shows an example.

Figure 64 Initial Setup Example: Management IP Address

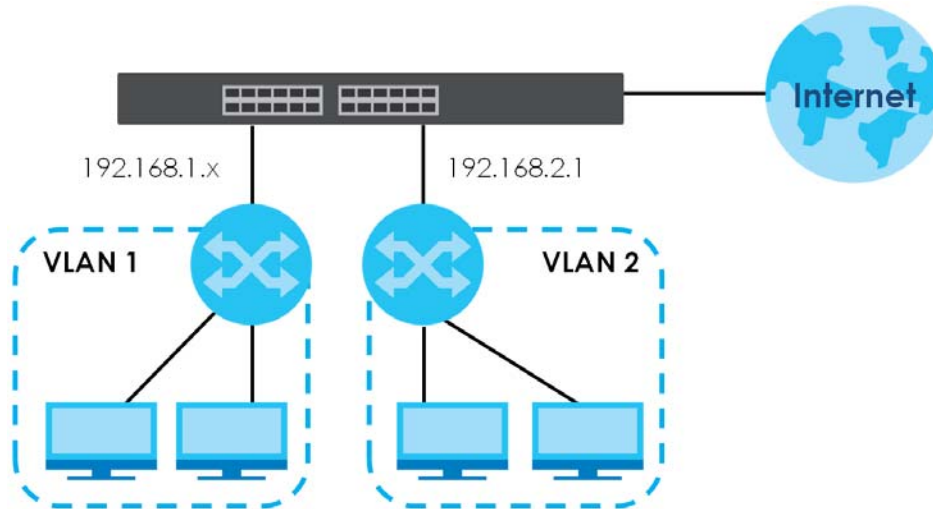

- 1 Connect your computer to any Ethernet port on the Switch. Make sure your computer is in the same subnet as the Switch.
- 2 Open your web browser and enter "setup.zyxel" or "192.168.1.1" (the default IP address) in the address bar to access the Web Configurator. See [Section 4.2 on page 50](#) for more information.

Note: You can always use the domain name "setup.zyxel" to access the Web Configurator whether the Switch is using a DHCP-assigned IP or static IP address. This requires your PC to be directly connected to the Switch.

- 3 Go to the **SYSTEM > IP Setup > IP Setup** screen. Click **Add/Edit**.

The screenshot shows the web interface for IP Setup. The 'IP Setup' tab is selected. The 'IP Setup' section contains three input fields: Default Gateway (0.0.0.0), Domain Name Server 1, and Domain Name Server 2. Below these fields are 'Apply' and 'Cancel' buttons. The 'IP Interface' section contains a table with one row of data. The 'Add/Edit' button is highlighted with a red box.

	Index	IP Address	IP Subnet Mask	VID	Type
<input type="checkbox"/>	1	172.21.40.2	255.255.252.0	1	DHCP

The following screen appears.

DHCP Client

Static IP Address

IP Address

IP Subnet Mask

VID

- 4 For the **VLAN2** network, enter 192.168.2.1 as the IP address and 255.255.255.0 as the subnet mask.
- 5 In the **VID** field, enter the ID of the VLAN group to which you want this management IP address to belong. In this example, enter VLAN ID 2. This is the same as the VLAN ID you configure in the **Static VLAN** screen.
- 6 Click **Apply** to save your changes back to the run-time memory. Settings in the run-time memory are lost when the Switch's power is turned off.

CHAPTER 6

Tutorials

6.1 Overview

This chapter provides some examples of using the Web Configurator to set up and use the Switch. The tutorials include:

- [How to Use DHCPv4 Relay on the Switch](#)

6.2 How to Use DHCPv4 Relay on the Switch

This tutorial describes how to configure your Switch to forward DHCP client requests to a specific DHCP server. The DHCP server can then assign a specific IP address based on the information in the DHCP requests.

6.2.1 DHCP Relay Tutorial Introduction

In this example, you have configured your DHCP server (192.168.2.3) and want to have it assign a specific IP address (say 172.16.1.18) to DHCP client **A** based on the system name, VLAN ID and port number in the DHCP request. Client **A** connects to the Switch's port 2 in VLAN 102.

Figure 65 Tutorial: DHCP Relay Scenario

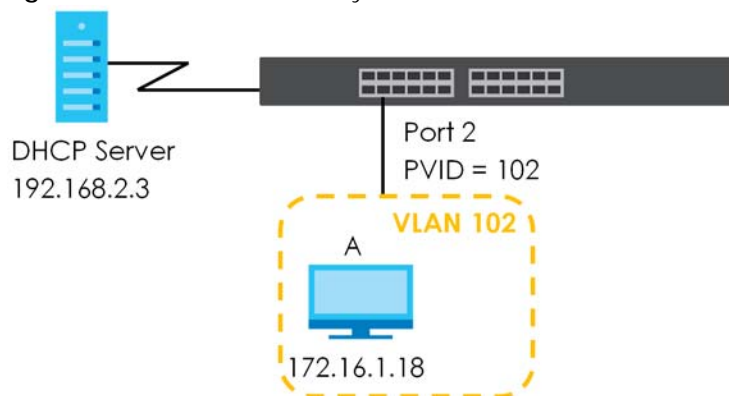

6.2.2 Create a VLAN

Follow the steps below to configure port 2 as a member of VLAN 102.

- 1 Access the Web Configurator through the Switch's management port.

- Go to **SYSTEM > Switch Setup** and set the **VLAN Type** to **802.1Q**. Click **Apply** to save the settings to the run-time memory.

Switch Setup

VLAN Type 802.1Q Port Based

MAC Address Learning

Aging Time seconds

ARP Aging Time

Aging Time seconds

Apply Cancel

- Go to **SWITCHING > VLAN > VLAN Setup > Static VLAN**. Click **Add/Edit**.

Static VLAN VLAN Port Setup GVRP

+ Add/Edit Delete

<input type="checkbox"/>	VID	Active	Name
<input type="checkbox"/>	1	ON	1

- The following screen appears. Enable the switch button to set this VLAN to **Active**. Enter a descriptive name (VLAN 102 for example) in the **Name** field and enter "102" in the **VLAN Group ID** field.

Active ON

Name

VLAN Group ID

Port	Control	Tagging
*	Normal	<input checked="" type="checkbox"/> Tx Tagging
1	<input checked="" type="radio"/> Normal <input type="radio"/> Fixed <input type="radio"/> Forbidden	<input checked="" type="checkbox"/> Tx Tagging
2	<input type="radio"/> Normal <input checked="" type="radio"/> Fixed <input type="radio"/> Forbidden	<input type="checkbox"/> Tx Tagging
3	<input checked="" type="radio"/> Normal <input type="radio"/> Fixed <input type="radio"/> Forbidden	<input checked="" type="checkbox"/> Tx Tagging
4	<input checked="" type="radio"/> Normal <input type="radio"/> Fixed <input type="radio"/> Forbidden	<input checked="" type="checkbox"/> Tx Tagging
5	<input checked="" type="radio"/> Normal <input type="radio"/> Fixed <input type="radio"/> Forbidden	<input checked="" type="checkbox"/> Tx Tagging
6	<input checked="" type="radio"/> Normal <input type="radio"/> Fixed <input type="radio"/> Forbidden	<input checked="" type="checkbox"/> Tx Tagging
7	<input checked="" type="radio"/> Normal <input type="radio"/> Fixed <input type="radio"/> Forbidden	<input checked="" type="checkbox"/> Tx Tagging
8	<input checked="" type="radio"/> Normal <input type="radio"/> Fixed <input type="radio"/> Forbidden	<input checked="" type="checkbox"/> Tx Tagging
9	<input checked="" type="radio"/> Normal <input type="radio"/> Fixed <input type="radio"/> Forbidden	<input checked="" type="checkbox"/> Tx Tagging

Apply Clear Cancel

- 5 Set port 2 to be a permanent member of this VLAN by selecting **Fixed** in the **Control** field.
- 6 Clear the **Tx Tagging** checkbox to set the Switch to remove VLAN tags before sending.
- 7 Click **Apply** to save the settings to the run-time memory. Settings in the run-time memory are lost when the Switch's power is turned off.
- 8 Go to **VLAN > VLAN Setup > VLAN Port Setup**. Enter "102" in the **PVID** field for port 2 to add a tag to incoming untagged frames received on that port so that the frames are forwarded to the VLAN group that the tag defines.

Port	Ingress Check	PVID	Acceptable Frame Type	VLAN Trunking	Isolation
*	<input type="checkbox"/>		All	<input type="checkbox"/>	<input type="checkbox"/>
1	<input type="checkbox"/>	1	All	<input type="checkbox"/>	<input type="checkbox"/>
2	<input type="checkbox"/>	102	All	<input type="checkbox"/>	<input type="checkbox"/>
3	<input type="checkbox"/>	1	All	<input type="checkbox"/>	<input type="checkbox"/>
4	<input type="checkbox"/>	1	All	<input type="checkbox"/>	<input type="checkbox"/>
5	<input type="checkbox"/>	1	All	<input type="checkbox"/>	<input type="checkbox"/>
6	<input type="checkbox"/>	1	All	<input type="checkbox"/>	<input type="checkbox"/>
7	<input type="checkbox"/>	1	All	<input type="checkbox"/>	<input type="checkbox"/>

- 9 Click **Apply** to save your changes back to the run-time memory.
- 10 Click the **Save** link in the upper right of the Web Configurator to save your configuration permanently.

6.2.3 Configure DHCPv4 Relay

Follow the steps below to enable DHCP relay on the Switch and allow the Switch to add relay agent information (such as the VLAN ID) to DHCP requests.

- 1 Click **NETWORKING > DHCP > DHCPv4 Relay > DHCP Smart Relay**. Enable the **Active** switch button.

- 2 Enter the DHCP server's IP address (192.168.2.3 in this example) in the **Remote DHCP Server 1** field.
- 3 Select **default1** or **default2** in the **Option 82 Profile** field.
- 4 Click **Apply** to save your changes back to the run-time memory.
- 5 Click the **Save** link in the upper right of the Web Configurator to save your configuration permanently.
- 6 The DHCP server can then assign a specific IP address based on the DHCP request.

6.2.4 Troubleshooting

Check client **A**'s IP address. If it did not receive the IP address 172.16.1.18, make sure:

- 1 Client **A** is connected to the Switch's port 2 in VLAN 102.
- 2 You configured the correct VLAN ID, port number and system name for DHCP relay on both the DHCP server and the Switch.
- 3 You clicked the **Save** link on the Switch to have your settings take effect.

CHAPTER 7

DASHBOARD

This chapter gives a quick introduction on the **DASHBOARD** screen.

The **DASHBOARD** screen automatically appears after you log into the Web Configurator.

7.1 New User Interface

With ZyNOS 4.80 and later, the Web Configurator's user interface is restructured. In the new **DASHBOARD** screen, you can easily monitor the system status with the following tools (see [DASHBOARD](#) for more information):

- Visualized **Port Status** section with clickable port icons that provide information of that port, an ON/OFF switch button to enable/disable the port, and a **Power Cycle** button to turn the power off to the PoE port and then back on again (see [Port Status](#)).
- Visualized **Cloud Control Status** section that displays the NCC connection status using three connection-stage circles.
- Clickable hardware status monitoring sections that directly link to the **MONITOR > System Information** screen.
- Editable **Quick Link** section which provides shortcuts to configuration screens that you might frequently use (See [Quick Links to Use](#)).
- A **Search** tool on the upper right of the screen that you can use to search for the configuration screens you want to access (see [Web Configurator Layout](#)).

The left navigation panel is also restructured into task-based UI. You can display the sub-menu in the **MONITOR**, **SYSTEM**, **PORT**, **SWITCHING**, **NETWORKING**, **SECURITY**, or the **MAINTENANCE** section by clicking their icons. See [Web Configurator Layout](#) for more information.

Find the latest release note in: [Download Library](#) on www.zyxel.com.

7.2 DASHBOARD

This screen displays general device information, system status, system resource usage, and port status.

This guide uses GS1350-26HP screens as an example. The screens may vary slightly for different models.

Click **DASHBOARD** in the navigation panel to open the following screen.

Figure 66 DASHBOARD (example PoE model)

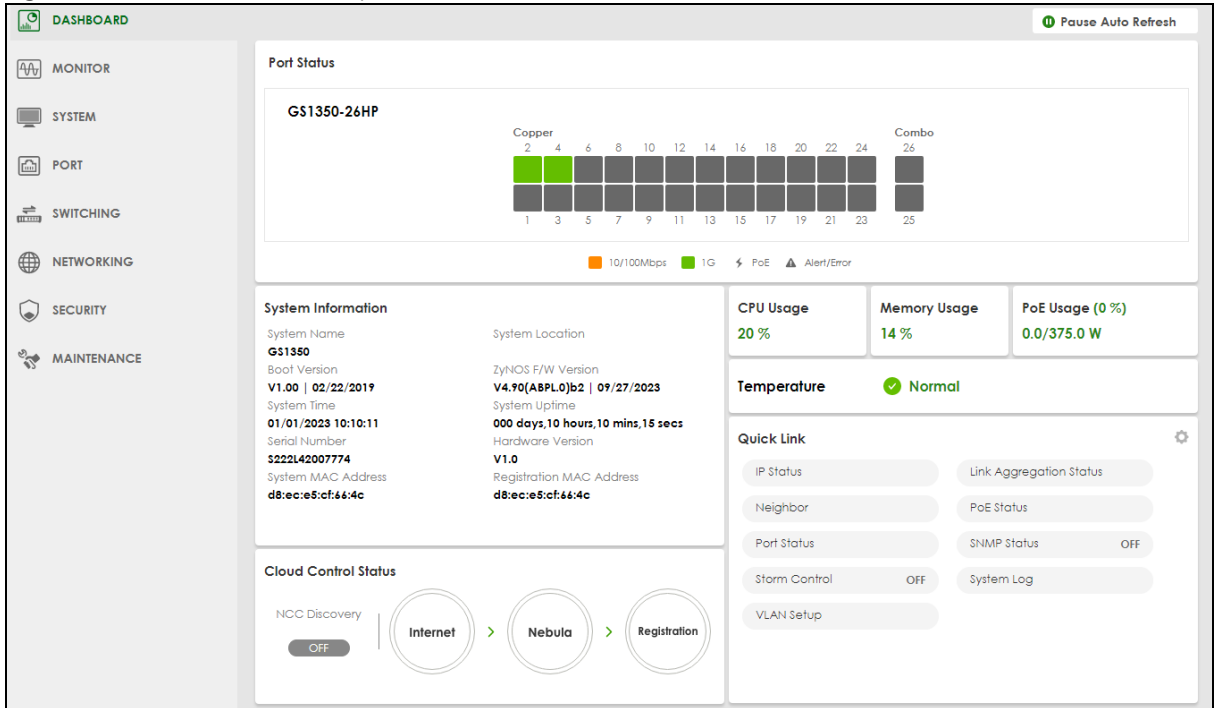

The following table describes the labels in this screen.

Table 21 DASHBOARD

LABEL	DESCRIPTION
Pause Auto Refresh	The DASHBOARD screen automatically refreshes every 30 seconds. Click this to disable the auto refresh. Click Resume Auto Refresh to enable.
Port Status	This displays individual port type, status, and connection speed of the Switch. Click on a port to open the port’s status panel. Use the status panel to enable/disable a port, power cycle a PoE port, and view its basic information. For example, link speed and port utilization. Note: The port status may vary for non-PoE and PoE models.
System Information	
System Name	This field displays the name used to identify the Switch on any network.
System Location	This field displays the geographic location name you set for the Switch.
Boot Version	This field displays the version number and date of the boot module that is currently on the Switch.
ZyNOS F/W Version	This field displays the version number and date of the firmware the Switch is currently running.
System Time	This field displays the current date and time in the UAG. The format is mm/dd/yyyy hh:mm:ss.
System Uptime	This field displays how long the Switch has been running since it last restarted or was turned on.
Serial Number	This field displays the serial number of this Switch. The serial number is used for device tracking and control.
Hardware Version	This field displays the hardware version of the Switch.

Table 21 DASHBOARD (continued)

LABEL	DESCRIPTION
System MAC Address	This field displays the MAC address of the Switch.
Registration MAC Address	This is the MAC address reserved for NCC registration. Use this MAC address to register the Switch on NCC.
Cloud Control Status	<p>This field displays:</p> <ul style="list-style-type: none"> The Switch Internet connection status. The connection status between the Switch and NCC. The Switch registration status on NCC. <p>Mouse over the circles to display detailed information.</p> <p>To pass your Switch management to NCC, first make sure your Switch is connected to the Internet. Then go to NCC and register your Switch.</p> <p>Click Cloud Control Status or the switch button to go to the SYSTEM > Cloud Management screen. You can enable/disable NCC Discovery or view the NCC connection status in the Cloud Management screen.</p> <p>1. Internet</p> <p>Green – The Switch is connected to the Internet. Orange – The Switch is not connected to the Internet.</p> <p>2. Nebula</p> <p>Green – The Switch is connected to NCC. Orange – The Switch is not connected to NCC.</p> <p>3. Registration</p> <p>Green – The Switch is registered on NCC. Gray – The Switch is not registered on NCC.</p> <p>Note: All circles will gray out if you disable Nebula Discovery.</p> <p>Note: If a circle displays orange or gray, hover the mouse over the circle to check the diagnostic message.</p>
NCC Discovery	<p>This displays if NCC discovery is enabled on the Switch. The Switch will connect to NCC and change to the NCC management mode if it:</p> <ul style="list-style-type: none"> is connected to the Internet. has been registered on NCC.
CPU Usage	<p>This displays the current CPU usage percentage.</p> <p>Click to go to the MONITOR > System Information screen to check the detailed information.</p>
Memory Usage	<p>This displays the current RAM usage percentage.</p> <p>Click to go to the MONITOR > System Information screen to check the detailed information.</p>
PoE Usage	<p>For PoE models.</p> <p>This field displays the amount of power the Switch is currently supplying to the connected PoE-enabled devices and the total power the Switch can provide to the connected PDs. It also shows the percentage of PoE power usage.</p> <p>When PoE usage reaches 100%, the Switch will shut down PDs one-by-one according to the PD priority which you configured in PORT > PoE Setup > PoE Setup.</p>

Table 21 DASHBOARD (continued)

LABEL	DESCRIPTION
Temperature	The Switch has temperature sensors that are capable of detecting and reporting if the temperature rises above the threshold. This displays the Switch's current device temperature level. Click to go to the MONITOR > System Information screen to check the detailed information.
Quick Link	This section provides shortcut links to specific configuration screens. Click the edit button to choose the quick links to show.

7.2.1 Port Status

The **Port Status** section provides visualized port status for monitoring. Each port displays a status color determined by their link speed.

Figure 67 Port Status (example PoE model)

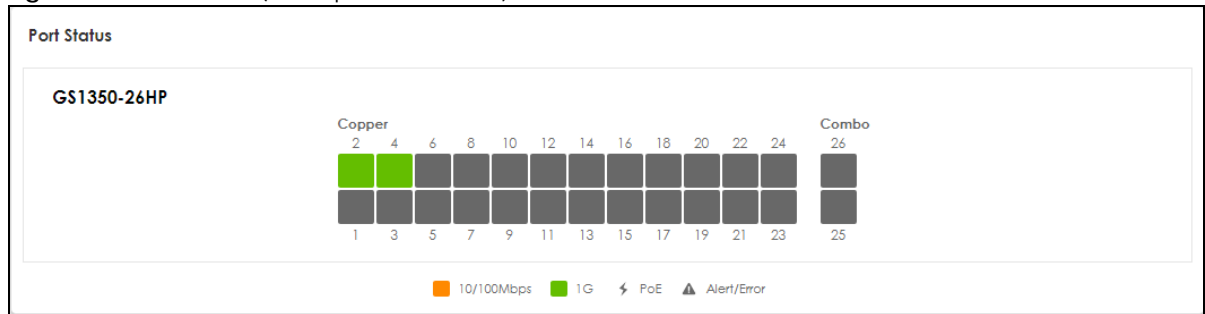

Click on a port to display a port's status pane.

Figure 68 Port details Pane (example PoE model)

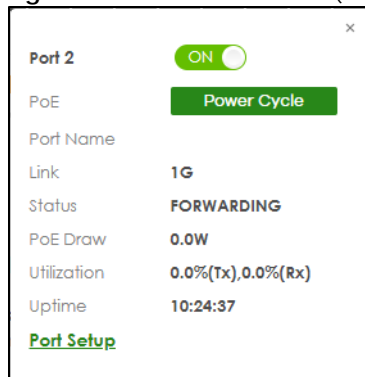

The port details pane includes the **Power Cycle** button for PoE models (turn the power off and then back on again), displays information such as link speed, status, PoE draw (for PoE models), port utilization, up time and has an ON/OFF switch button. Click the switch button to enable/disable the port. Click **Port Setup** to go to **PORT > Port Setup > Port Setup**.

7.2.2 Quick Links to Use

The quick links in the **Quick Link** section provide shortcuts to specific configuration screens. You can use the quick links to directly access the screens that you would frequently use. You can also decide which quick links to be put on the **DASHBOARD** screen using the **Edit** button.

Figure 69 Quick Links (example PoE model)

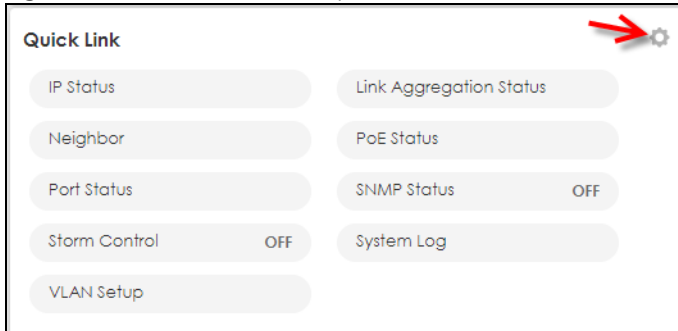

The setup panel displays after you click the **Edit** button.

Figure 70 Quick Link Selection (example PoE model)

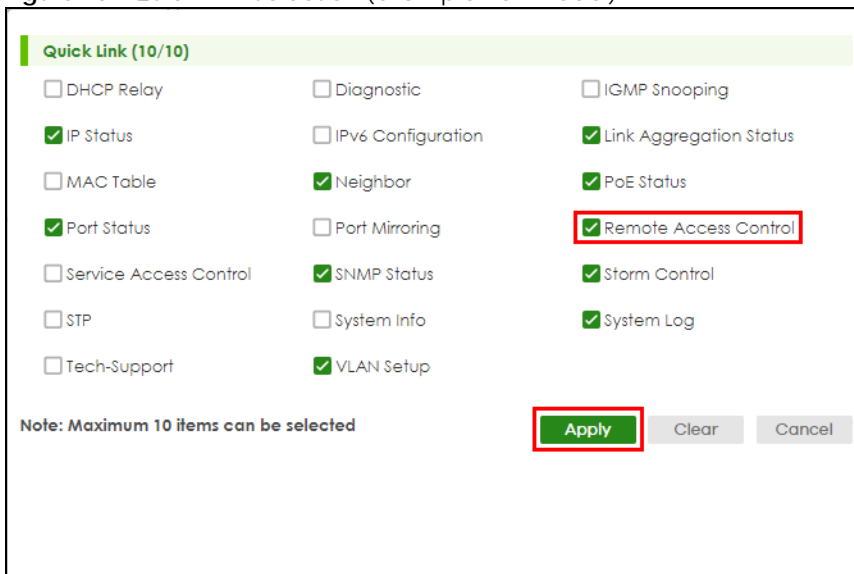

Select the quick links you want and click **Apply**. The selected quick links will be displayed in the **Quick Link** section on the **DASHBOARD** screen.

CHAPTER 8

MONITOR

The following chapters introduces the configurations of the links under the **MONITOR** navigation panel.

Quick links to chapters:

- [ARP Table](#)
- [IPv6 Neighbor Table](#)
- [MAC Table](#)
- [Neighbor](#)
- [Path MTU Table](#)
- [Port Status](#)
- [System Information](#)
- [System Log](#)

CHAPTER 9

ARP Table

9.1 ARP Table Overview

This chapter introduces the ARP Table.

Address Resolution Protocol (ARP) is a protocol for mapping an Internet Protocol address (IP address) to a physical machine address, also known as a Media Access Control or MAC address, on the local area network.

An IP (version 4) address is 32 bits long. In an Ethernet LAN, MAC addresses are 48 bits long. The ARP Table maintains an association between each MAC address and its corresponding IP address.

9.1.1 What You Can Do

Use the **ARP Table** screen ([Section 9.2 on page 96](#)) to view IP-to-MAC address mappings.

9.1.2 What You Need to Know

When an incoming packet destined for a host device on a local area network arrives at the Switch, the Switch's ARP program looks in the ARP Table and if it finds the address, it sends it to the device.

If no entry is found for the IP address, ARP broadcasts the request to all the devices on the LAN. The Switch fills in its own MAC and IP address in the sender address fields, and puts the known IP address of the target in the target IP address field. In addition, the Switch puts all ones in the target MAC field (FF.FF.FF.FF.FF.FF is the Ethernet broadcast address). The replying device (which is either the IP address of the device being sought or the router that knows the way) replaces the broadcast address with the target's MAC address, swaps the sender and target pairs, and unicasts the answer directly back to the requesting machine. ARP updates the ARP Table for future reference and then sends the packet to the MAC address that replied.

9.2 Viewing the ARP Table

Use the ARP table to view IP-to-MAC address mappings and remove specific dynamic ARP entries.

Click **MONITOR > ARP Table** in the navigation panel to open the following screen.

Figure 71 MONITOR > ARP Table

Index	IP Address	MAC Address	VID	Port	Age(s)	Type

The following table describes the labels in this screen.

Table 22 MONITOR > ARP Table

LABEL	DESCRIPTION
Condition	Specify how you want the Switch to remove ARP entries when you click Flush . Select All to remove all of the dynamic entries from the ARP table. Select IP Address and enter an IP address to remove the dynamic entries learned with the specified IP address. Select Port and enter a port number to remove the dynamic entries learned on the specified port. You can enter multiple ports separated by (no space) comma (,) or hyphen (-) for a range. For example, enter "3-5" for ports 3, 4, and 5. Enter "3,5,7" for ports 3, 5, and 7.
Flush	Click Flush to remove the ARP entries according to the condition you specified.
Cancel	Click Cancel to return the fields to the factory defaults.
Index	This is the ARP table entry number.
IP Address	This is the IP address of a device connected to a Switch port with the corresponding MAC address below.
MAC Address	This is the MAC address of the device with the corresponding IP address above.
VID	This field displays the VLAN to which the device belongs.
Port	This field displays the port to which the device connects. CPU means this IP address is the Switch's management IP address.
Age(s)	This field displays how long (in seconds) an entry can still remain in the ARP table before it ages out and needs to be relearned. This shows 0 for a static entry.
Type	This shows whether the IP address is dynamic (learned by the Switch) or static (manually configured in SYSTEM > IP Setup > IP Setup or NETWORKING > ARP Setup > Static ARP).

CHAPTER 10

IPv6 Neighbor Table

10.1 IPv6 Neighbor Table Overview

This chapter introduces the IPv6 neighbor table.

An IPv6 host is required to have a neighbor table. If there is an address to be resolved or verified, the Switch sends out a neighbor solicitation message. When the Switch receives a neighbor advertisement in response, it stores the neighbor's link-layer address in the neighbor table. You can also manually create a static IPv6 neighbor entry using the **SYSTEM > IPv6 > IPv6 Neighbor Setup** screen.

When the Switch needs to send a packet, it first consults other table to determine the next hop. Once the next hop IPv6 address is known, the Switch looks into the neighbor table to get the link-layer address and sends the packet when the neighbor is reachable. If the Switch cannot find an entry in the neighbor table or the state for the neighbor is not reachable, it starts the address resolution process. This helps reduce the number of IPv6 solicitation and advertisement messages.

10.2 Viewing the IPv6 Neighbor Table

Use this screen to view IPv6 neighbor information on the Switch. Click **MONITOR > IPv6 Neighbor Table** in the navigation panel to display the screen as shown.

Figure 72 MONITOR > IPv6 Neighbor Table

Index	Address	MAC	Status	Type	Interface
1	fa80::1:0:0000:0000:0000:0000	00:00:00:00:00:00	Invalid	Dynamic	VLAN1
2	fa80::2:0:0000:0000:0000:0000	00:00:00:00:00:00	Invalid	Dynamic	VLAN1
3	fa80::3:0:0000:0000:0000:0000	08:00:5e:0f:44:10	Reachable	Local	VLAN1

Sorting by: Address MAC Interface

The following table describes the labels in this screen.

Table 23 MONITOR > IPv6 Neighbor Table

LABEL	DESCRIPTION
Index	This field displays the index number of each entry in the table.
Address	This field displays the IPv6 address of the Switch or a neighboring device.
MAC	This field displays the MAC address of the IPv6 interface on which the IPv6 address is configured or the MAC address of the neighboring device.

Table 23 MONITOR > IPv6 Neighbor Table (continued)

LABEL	DESCRIPTION
Status	<p>This field displays whether the neighbor IPv6 interface is reachable. In IPv6, "reachable" means an IPv6 packet can be correctly forwarded to a neighbor node (host or router) and the neighbor can successfully receive and handle the packet. The available options in this field are:</p> <ul style="list-style-type: none"> • reachable (R): The interface of the neighboring device is reachable. (The Switch has received a response to the initial request.) • stale (S): The last reachable time has expired and the Switch is waiting for a response to another initial request. The field displays this also when the Switch receives an unrequested response from the neighbor's interface. • delay (D): The neighboring interface is no longer known to be reachable, and traffic has been sent to the neighbor recently. The Switch delays sending request packets for a short to give upper-layer protocols a chance to determine reachability. • probe (P): The Switch is sending request packets and waiting for the neighbor's response. • invalid (IV): The neighbor address is with an invalid IPv6 address. • unknown (?): The status of the neighboring interface cannot be determined for some reason. • incomplete (I): Address resolution is in progress and the link-layer address of the neighbor has not yet been determined. The interface of the neighboring device did not give a complete response.
Type	<p>This field displays the type of an address mapping to a neighbor interface. The available options in this field are:</p> <ul style="list-style-type: none"> • other (O): none of the following type. • local (L): A Switch interface is using the address. • dynamic (D): The IP address to MAC address can be successfully resolved using IPv6 Neighbor Discovery protocol. Is it similar as IPv4 ARP (Address Resolution protocol). • static (S): The interface address is statically configured.
Interface	<p>This field displays the ID number of the IPv6 interface on which the IPv6 address is created or through which the neighboring device can be reached.</p>
Sorting by	<p>Click one of the following buttons to display and arrange the data according to that button type. The result is then displayed in the summary table above.</p>
Address	<p>Click this button to display and arrange the data according to IPv6 address.</p>
MAC	<p>Click this button to display and arrange the data according to MAC address.</p>
Interface	<p>Click this button to display and arrange the data according to IPv6 interface.</p>

CHAPTER 11

MAC Table

11.1 MAC Table Overview

This chapter introduces the **MAC Table** screen.

The **MAC Table** screen (a MAC table is also known as a filtering database) shows how frames are forwarded or filtered across the Switch's ports. It shows what device MAC address, belonging to what VLAN group (if any) is forwarded to which ports and whether the MAC address is dynamic (learned by the Switch) or static (manually entered in the **SWITCHING > Static MAC Forwarding** screen).

11.1.1 What You Can Do

Use the **MAC Table** screen ([Section 11.2 on page 101](#)) to check whether the MAC address is dynamic or static.

11.1.2 What You Need to Know

The Switch uses the **MAC Table** to determine how to forward frames. See the following figure.

- 1 The Switch examines a received frame and learns the port on which this source MAC address came.
- 2 The Switch checks to see if the frame's destination MAC address matches a source MAC address already learned in the **MAC Table**.
 - If the Switch has already learned the port for this MAC address, then it forwards the frame to that port.
 - If the Switch has not already learned the port for this MAC address, then the frame is flooded to all ports. Too much port flooding leads to network congestion, then the Switch sends an ARP to request the MAC address. The Switch then learns the port that replies with the MAC address.
 - If the Switch has already learned the port for this MAC address, but the destination port is the same as the port it came in on, then it filters the frame.

Figure 73 MAC Table Flowchart

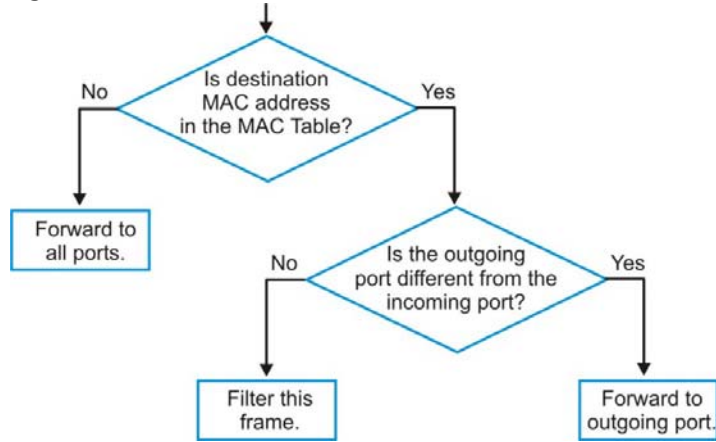

11.2 Viewing the MAC Table

Use this screen to search specific MAC addresses. You can also directly add dynamic MAC addresses into the static MAC forwarding table or MAC filtering table from the MAC table using this screen.

Click **MONITOR > MAC Table** in the navigation panel to display the following screen.

Figure 74 MONITOR > MAC Table

MAC Table

All
 Static
 MAC
 VID
 Port
 Trunk

Sort by:

Dynamic to MAC forwarding
 Dynamic to MAC filtering

Index	MAC Address	VID	Port	Type
1	00-00-5e-00-01-04	1	2	Dynamic
2	00-04-96-9e-3e-1c	1	2	Dynamic
3	00-11-22-33-44-55	1	2	Dynamic

The following table describes the labels in this screen.

Table 24 MONITOR > MAC Table

LABEL	DESCRIPTION
Condition	<p>Select one of the below search conditions and click Search to only display the data which matches the criteria you specified.</p> <p>Select All to display any entry in the MAC table of the Switch.</p> <p>Select Static to display the MAC entries manually configured on the Switch.</p> <p>Select MAC and enter a MAC address in the field provided to display a specified MAC entry.</p> <p>Select VID and enter a VLAN ID in the field provided to display the MAC entries belonging to the specified VLAN.</p> <p>Select Port and enter a port number in the field provided to display the MAC addresses which are forwarded on the specified port.</p> <p>Select Trunk and type the ID of a trunk group to display all MAC addresses learned from the ports in the trunk group.</p>
Sort by	<p>Define how the Switch displays and arranges the data in the summary table below.</p> <p>Select MAC to display and arrange the data according to MAC address.</p> <p>Select VID to display and arrange the data according to VLAN group.</p> <p>Select PORT to display and arrange the data according to port number.</p>
Type Transfer	<p>Select Dynamic to MAC forwarding and click the Transfer button to change all dynamically learned MAC address entries in the summary table below into static entries. They also display in the SWITCHING > Static MAC Forwarding screen.</p> <p>Select Dynamic to MAC filtering and click the Transfer button to change all dynamically learned MAC address entries in the summary table below into MAC filtering entries. These entries will then display only in the SWITCHING > Static MAC Filtering screen and the default filtering action is Discard source.</p>
Search	Click this to search data in the MAC table according to your input criteria.
Transfer	Click this to perform the MAC address transferring you selected in the Type Transfer field.
Cancel	Click Cancel to change the fields back to their last saved values.
Index	This is the incoming frame index number.
MAC Address	This is the MAC address of the device from which this incoming frame came.
VID	This is the VLAN group to which this frame belongs.
Port	This is the port where the above MAC address is forwarded.
Type	This shows whether the MAC address is Dynamic (learned by the Switch) or Static (manually entered in the SWITCHING > Static MAC Forwarding screen).

CHAPTER 12

Neighbor

12.1 Neighbor Overview

The **Neighbor** screen allows you to view a summary and manage the Switch's neighboring devices. It uses Layer Link Discovery Protocol (LLDP) to discover all neighbor devices connected to the Switch including non-Zyxel devices. You can use this screen to perform tasks on the neighboring devices like login, power cycle (turn the power off and then back on again), and reset to factory default settings.

This screen shows the neighboring device first recognized on an Ethernet port of the Switch. Device information is displayed in gray when the neighboring device is offline.

12.1.1 What You Can Do

Use the **Neighbor** screen ([Section 12.2 on page 103](#)) to view a summary and manage the Switch's neighbor devices.

Use the **Neighbor Details** screen ([Section 12.2.1 on page 104](#)) to view more detailed information on the Switch's neighbor devices.

12.2 Neighbor

Click **MONITOR > Neighbor** to see the following screen.

Figure 75 MONITOR > Neighbor > Neighbor

Port	Port Name	PD Health	Link	PoE Draw(W)	System Name	IPv4	IPv6	Action
1		--	Down	0.0	--			Reset Restore
2		--	1G/F	0.0	12A3_84	0.0.0.0	--	Reset Restore
3		--	Down	0.0	--			Reset Restore
4		--	1G/F	0.0	--	--	--	Reset Restore
5		--	Down	0.0	--			Reset Restore
6		--	1G/F	0.0	--	--	--	Reset Restore
7		--	Down	0.0	--			Reset Restore
8		--	Down	0.0	--			Reset Restore
9		--	Down	0.0	--			Reset Restore

The following table describes the fields in the above screen.

Table 25 MONITOR > Neighbor > Neighbor

LABEL	DESCRIPTION
Port	This shows the port of the Switch, on which the neighboring device is discovered.
Port Name	This shows the port description of the Switch.
PD Health	<p>For PoE models.</p> <p>This shows the status of auto PD recovery on this port.</p> <ul style="list-style-type: none"> Red: The Switch failed to get information from the PD connected to the port using LLDP, or the connected PD did not respond to the Switch's ping requests. Yellow: The Switch is restarting the connected PD by turning the power off and turning it on again. Green: The Switch successfully discovered the connected PD using LLDP or ping. -: Auto PD Recovery is not enabled on the Switch and the port, or the Switch does not supply power to the connected PD. <p>Note: The status will NOT be updated instantaneously after enabling or disabling the Active switch in the Port > Auto PD Recovery screen. It will wait until the configured Resume Polling Interval (sec) has lapsed.</p>
Link	This shows the speed (either 10M for 10 Mbps, 100M for 100 Mbps, 1G for 1 Gbps, or 10G for 10 Gbps) and the duplex (F for full duplex or H for half). This field displays Down if the port is not connected to any device.
PoE Draw (W)	<p>For PoE models.</p> <p>This shows the consumption that the neighboring device connected to this port draws from the Switch. This allows you to plan and use within the power budget of the Switch.</p>
System Name	This shows the system name of the neighbor device.
IPv4	This shows the IPv4 address of the neighbor device. The IPv4 address is a hyper link that you can click to log into and manage the neighbor device through its Web Configurator.
IPv6	This shows the IPv6 address of the neighbor device. The IPv6 address is a hyper link that you can click to log into and manage the neighbor device through its Web Configurator.
Action	<p>For PoE models.</p> <p>Click the Reset button to turn OFF the power of the neighbor device and turn it back ON again. A count down button (from 5 to 0) starts.</p> <p>Note: The Switch must support power sourcing (PSE) or the network device is a powered device (PD).</p> <p>Click the Restore button to restore the neighboring device to its factory default settings. A warning message "Are you sure you want to load factory default?" appears prompting you to confirm the action. After confirming the action a count down button (from 5 to 0) starts.</p> <p>Note:</p> <ul style="list-style-type: none"> The Switch must support power sourcing (PSE) or the network device is a powered device (PD). If multiple neighbor devices use the same port, the Reset button is not available. You can only reset Zyxel powered devices that support the ZON utility.

12.2.1 Neighbor Details

Use this screen to view detailed information about the neighboring devices. Device information is displayed in gray when the neighboring device is currently offline.

Up to 10 neighboring device records per Ethernet port can be retained in this screen even when the

devices are offline. When the maximum number of neighboring device records per Ethernet port is reached, new device records automatically overwrite existing offline device records, starting with the oldest existing offline device record first.

Click **MONITOR > Neighbor > Neighbor Details** to see the following screen.

Figure 76 MONITOR > Neighbor > Neighbor Details (example PoE model)

The following table describes the fields in the above screen.

Table 26 MONITOR > Neighbor > Neighbor Details

LABEL	DESCRIPTION
Search Ports...	Enter the port number to search and display the ports you specified. The result will display in the below list. You can enter multiple ports separated by comma (",") or hyphen ("-") for a range. For example, enter "3-5" for ports 3, 4, and 5. Enter "3,5,7" for ports 3, 5, and 7.
Port	This shows the port of the Switch, on which the neighboring device is discovered.
Desc.	This shows the port description of the Switch.
PD Health	For PoE models. This shows the status of auto PD recovery on this port. <ul style="list-style-type: none"> Red: The Switch failed to get information from the PD connected to the port using LLDP, or the connected PD did not respond to the Switch's ping requests. Yellow: The Switch is restarting the connected PD by turning the power off and turning it on again. Green: The Switch successfully discovered the connected PD using LLDP or ping. -: Auto PD Recovery is not enabled on the Switch and the port, or the Switch does not supply power to the connected PD.
Link Speed	This shows the speed (either 10M for 10 Mbps, 100M for 100 Mbps, 1G for 1 Gbps, 2.5G for 2.5 Gbps, 5G for 5 Gbps, or 10G for 10 Gbps) and the duplex (F for full duplex or H for half). This field displays Down if the port is not connected to any device.
PoE Draw (W)	For PoE models. This shows the consumption that the neighboring device connected to this port draws from the Switch. This allows you to plan and use within the power budget of the Switch.

Table 26 MONITOR > Neighbor > Neighbor Details (continued)

LABEL	DESCRIPTION
Reset	<p>Click this button to turn OFF the power of the neighbor device and turn it back ON again. A count down button (from 5 to 0) starts.</p> <p>Note: The Switch must support power sourcing (PSE) or the network device is a powered device (PD).</p>
Remote	
System Name	This shows the system name of the neighbor device.
Port Bridge	This shows the neighboring device's MAC address or the port number connected to the Switch.
Model	This shows the model name of the neighbor device. This field will show "-" for devices that do not support the ZON utility.
MAC	This shows the MAC address of the neighbor device.
Firmware	This shows the firmware version of the neighbor device. This field will show "-" for devices that do not support the ZON utility.
Location	This shows the geographic location of the neighbor device. This field will show "-" for devices that do not support the ZON utility.
Desc.	This shows the description of the neighbor device's port which is connected to the Switch.
IPv4	This shows the IPv4 address of the neighbor device. The IPv4 address is a hyper link that you can click to log into and manage the neighbor device through its Web Configurator.
IPv6	This shows the IPv6 address of the neighbor device. The IPv6 address is a hyper link that you can click to log into and manage the neighbor device through its Web Configurator.
Restore	<p>Click this button to restore the neighbor device to its factory default settings. A warning message "Are you sure you want to load factory default?" appears prompting you to confirm the action. After confirming the action a count down button (from 5 to 0) starts.</p> <p>Note:</p> <ul style="list-style-type: none"> • The Switch must support power sourcing (PSE) or the network device is a powered device (PD). • If multiple neighbor devices use the same port, the Reset button is not available. • You can only reset Zyxel powered devices that support the ZON utility.
Flush	Click the Flush button on the port tab to remove information about neighbors learned on a specific ports.
Flush All	Click the Flush All button to remove information about neighbors learned on all ports.

CHAPTER 13

Path MTU Table

13.1 Path MTU Overview

This chapter introduces the IPv6 Path MTU table.

The largest size (in bytes) of a packet that can be transferred over a data link is called the Maximum Transmission Unit (MTU). The Switch uses Path MTU Discovery to discover Path MTU (PMTU), that is, the minimum link MTU of all the links in a path to the destination. If the Switch receives an ICMPv6 Packet Too Big error message after sending a packet, it fragments the next packet according to the suggested MTU in the error message.

13.2 Viewing the Path MTU Table

Use this screen to view IPv6 path MTU information on the Switch. Click **MONITOR > Path MTU Table** in the navigation panel to display the screen as shown.

Figure 77 MONITOR > Path MTU Table

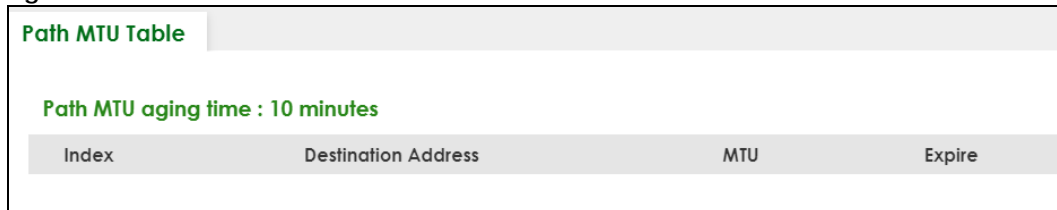

Index	Destination Address	MTU	Expire
-------	---------------------	-----	--------

The following table describes the labels in this screen.

Table 27 MONITOR > Path MTU Table

LABEL	DESCRIPTION
Path MTU aging time	This field displays how long an entry remains in the Path MTU table before it ages out and needs to be relearned.
Index	This field displays the index number of each entry in the table.
Destination Address	This field displays the destination IPv6 address of each path or entry.
MTU	This field displays the maximum transmission unit of the links in the path.
Expire	This field displays how long (in minutes) an entry can still remain in the Path MTU table before it ages out and needs to be relearned.

CHAPTER 14

Port Status

This chapter introduces the **Port Status** screens.

14.0.1 What You Can Do

Use the **Port Status** screen (Section 14.1 on page 108) to view the port status of the Switch.

Use the **DDMI** screen (Section 14.2 on page 112) to view the DDMI (Digital Diagnostics Monitoring Interface) status of the SFP transceivers on the Switch.

Use the **Port Utilization** screen (Section 14.3 on page 114) to view the current data rate and utilization percentage of each port on the Switch.

14.1 Port Status

This screen displays a port statistical summary with links to each port showing statistical details. To view the port statistics, click **MONITOR > Port Status** to display the **Port Status** screen as shown next. You can also click the **Port Status** link in the **Quick Link** section of the **DASHBOARD** screen to see the following screen.

Figure 78 MONITOR > Port Status > Port Status

Port Status											
Port	Name	Link	State	PD	LACP	TxPkts	RxPkts	Errors	Tx kB/s	Rx kB/s	Up Time
1		Down	STOP	Off	Disabled	0	0	0	0.0	0.0	0:00:00
2		1G/F	FORWARDING	Off	Disabled	200558	339071	0	0.194	2.800	1:45:03
3		Down	STOP	Off	Disabled	0	0	0	0.0	0.0	0:00:00
4		Down	STOP	Off	Disabled	0	0	0	0.0	0.0	0:00:00
5		Down	STOP	Off	Disabled	0	0	0	0.0	0.0	0:00:00
6		1G/F	FORWARDING	Off	Disabled	334799	197102	0	0.383	1.220	1:44:53
7		Down	STOP	Off	Disabled	0	0	0	0.0	0.0	0:00:00
8		Down	STOP	Off	Disabled	0	0	0	0.0	0.0	0:00:00
9		Down	STOP	Off	Disabled	0	0	0	0.0	0.0	0:00:00
10		Down	STOP	Off	Disabled	0	0	0	0.0	0.0	0:00:00

Clear the counter: All Ports Port

The following table describes the labels in this screen.

Table 28 MONITOR > Port Status > Port Status

LABEL	DESCRIPTION
Port	This identifies the Ethernet port. Click a port number to display the Port Details screen.
Name	This is the name you assigned to this port in the PORT > Port Setup screen.
Link	This field displays the speed (either 10M for 10 Mbps, 100M for 100 Mbps, or 1G for 1 Gbps) and the duplex (F for full duplex or H for half). It also shows the cable type (Copper or Fiber) for the combo ports. This field displays Down if the port is not connected to any device.
State	If STP (Spanning Tree Protocol) is enabled, this field displays the STP state of the port. If STP is disabled, this field displays FORWARDING if the link is up, otherwise, it displays STOP . When LACP (Link Aggregation Control Protocol) and STP are in blocking state, it displays BLOCKING .
PD	For PoE models only. This field displays whether or not a powered device (PD) is allowed to receive power from the Switch on this port.
LACP	This field displays whether LACP (Link Aggregation Control Protocol) has been enabled on the port.
TxPkts	This field shows the number of transmitted frames on this port.
RxPkts	This field shows the number of received frames on this port.
Errors	This field shows the number of received errors on this port.
Tx kB/s	This field shows the number of kilobytes per second transmitted on this port.
Rx kB/s	This field shows the number of kilobytes per second received on this port.
Up Time	This field shows the total amount of time in hours, minutes and seconds the port has been up.
Clear the counter	Select Port , enter a port number and then click Clear Counter to erase the recorded statistical information for that port, or select ALL Ports to clear statistics for all ports.

14.1.1 Port Details

Click an index in the **Port** column in the **MONITOR > Port Status > Port Status** screen to display individual port statistics. Use this screen to check status and detailed performance data about an individual port on the Switch.

Figure 79 MONITOR > Port Status > Port Status > Port Details

Port Status		DDMI	Port Utilization	
Port Status > Port Details				
Port Info			TX Packet	
Port NO.	2		Unicast	218648
Name			Multicast	1113
Link	1G/F		Broadcast	127
State	FORWARDING		Pause	0
LACP	Disabled		RX Packet	
TxPkts	219888		Unicast	297357
RxPkts	383699		Multicast	57130
Errors	0		Broadcast	29212
Tx kB/s	1.330		Pause	0
Tx Utilization%	0.0		TX Collision	
Rx kB/s	0.548		Single	0
Rx Utilization%	0.0		Multiple	0
Up Time	2:11:10		Excessive	0
			Late	0
Error Packet			Distribution	
RX CRC	0		64	173139
Length	0		65 to 127	84669
Runt	0		128 to 255	151095
			256 to 511	25133
			512 to 1023	11039
			1024 to 1518	158512
			Giant	0

The following table describes the labels in this screen.

Table 29 MONITOR > Port Status > Port Status > Port Details

LABEL	DESCRIPTION
Port Info	
Port NO.	This field displays the port number you are viewing.
Name	This field displays the name of the port.
Link	This field displays the speed (either 10M for 10 Mbps, 100M for 100 Mbps, or 1G for 1 Gbps) and the duplex (F for full duplex or H for half duplex). It also shows the cable type (Copper or Fiber) for the combo ports. This field displays Down if the port is not connected to any device.
State	If STP (Spanning Tree Protocol) is enabled, this field displays the STP state of the port. If STP is disabled, this field displays FORWARDING if the link is up, otherwise, it displays STOP . When LACP (Link Aggregation Control Protocol), STP, and dot1x are in blocking state, it displays BLOCKING .
LACP	This field shows if LACP is enabled on this port or not.
TxPkts	This field shows the number of transmitted frames on this port.
RxPkts	This field shows the number of received frames on this port.
Errors	This field shows the number of received errors on this port.
Tx kB/s	This field shows the number of kilobytes per second transmitted on this port.

Table 29 MONITOR > Port Status > Port Status > Port Details (continued)

LABEL	DESCRIPTION
Tx Utilization%	This field shows the percentage of actual transmitted frames on this port as a percentage of the Link speed.
Rx kB/s	This field shows the number of kilobytes per second received on this port.
Rx Utilization%	This field shows the percentage of actual received frames on this port as a percentage of the Link speed.
Up Time	This field shows the total amount of time the connection has been up.
TX Packet	
The following fields display detailed information about packets transmitted.	
Unicast	This field shows the number of good unicast packets transmitted.
Multicast	This field shows the number of good Multicast packets transmitted.
Broadcast	This field shows the number of good broadcast packets transmitted.
Pause	This field shows the number of 802.3x pause packets transmitted.
RX Packet	
The following fields display detailed information about packets received.	
Unicast	This field shows the number of good unicast packets received.
Multicast	This field shows the number of good Multicast packets received.
Broadcast	This field shows the number of good broadcast packets received.
Pause	This field shows the number of 802.3x pause packets received.
TX Collision	
The following fields display information on collisions while transmitting.	
Single	This is a count of successfully transmitted packets for which transmission is inhibited by exactly one collision.
Multiple	This is a count of successfully transmitted packets for which transmission was inhibited by more than one collision.
Excessive	This is a count of packets for which transmission failed due to excessive collisions. Excessive collision is defined as the number of maximum collisions before the retransmission count is reset.
Late	This is the number of times a late collision is detected, that is, after 512 bits of the packets have already been transmitted.
Error Packet	
The following fields display detailed information about packets received that were in error.	
RX CRC	This field shows the number of packets received with CRC (Cyclic Redundant Check) errors.
Length	This field shows the number of packets received with a length that was out of range.
Runt	This field shows the number of packets received that were too short (shorter than 64 octets), including the ones with CRC errors.
Distribution	
64	This field shows the number of packets (including bad packets) received that were 64 octets in length.
65 to 127	This field shows the number of packets (including bad packets) received that were between 65 and 127 octets in length.
128 to 255	This field shows the number of packets (including bad packets) received that were between 128 and 255 octets in length.
256 to 511	This field shows the number of packets (including bad packets) received that were between 256 and 511 octets in length.

Table 29 MONITOR > Port Status > Port Status > Port Details (continued)

LABEL	DESCRIPTION
512 to 1023	This field shows the number of packets (including bad packets) received that were between 512 and 1023 octets in length.
1024 to 1518	This field shows the number of packets (including bad packets) received that were between 1024 and 1518 octets in length.
Giant	This field shows the number of packets (including bad packets) received that were between 1519 octets and the maximum frame size. The maximum frame size varies depending on your switch model.

14.2 DDMI

The optical SFP transceiver's support for the Digital Diagnostics Monitoring Interface (DDMI) function lets you monitor the transceiver's parameters to perform component monitoring, fault isolation and failure prediction tasks. This allows proactive, preventative network maintenance to help ensure service continuity.

Use this screen to view the DDMI status of the Switch's SFP transceivers. Click **MONITOR > Port Status > DDMI** to see the following screen. Alternatively, click **DASHBOARD** from any Web Configurator screen and then the **Port Status** link in the **Quick Link** section of the **DASHBOARD** screen to display the **Port Status** screen and then click the **DDMI** link tab.

Figure 80 MONITOR > Port Status > DDMI

Port Status	DDMI	Port Utilization				
Port	Vendor	Part Number	Serial Number	Revision	Date Code	Transceiver
16	ZyXEL	SFP-1000T	S111111111111	1.0	2017-12-20	1000BASE-T

The following table describes the labels in this screen.

Table 30 MONITOR > Port Status > DDMI

LABEL	DESCRIPTION
Port	This identifies the SFP port. Click a port number to display the DDMI Details screen.
Vendor	This displays the vendor name of the optical transceiver.
Part Number	This displays the part number of the optical transceiver.
Serial Number	This displays the serial number of the optical transceiver.
Revision	This displays the revision number of the optical transceiver.
Date Code	This displays the date when the optical transceiver was manufactured.
Transceiver	This displays the type of optical transceiver installed in the SFP slot.

14.2.1 DDMI Details

Use this screen to view the real-time SFP (Small Form Factor Pluggable) transceiver information and operating parameters on the SFP port. The parameters include, for example, transmitting and receiving power, and module temperature.

Click an index in the **Port** column in the **DDMI** screen to view current transceivers' status.

Figure 81 MONITOR > Port Status > DDMI > DDMI Details

Port Status	DDMI	Port Utilization			
DDMI > DDMI Details					
Transceiver Information					
Port No	9				
Connector Type	-				
Vendor	-				
Part Number	-				
Serial Number	-				
Revision	-				
Date Code	-				
Transceiver	-				
DDMI Information					
Type	Current	High Alarm Threshold	High Warn Threshold	Low Warn Threshold	Low Alarm Threshold
Temperature(C)	-	-	-	-	-
Voltage(V)	-	-	-	-	-
TX Bias(mA)	-	-	-	-	-
TX Power(dbm)	-	-	-	-	-
RX Power(dbm)	-	-	-	-	-

The following table describes the labels in this screen.

Table 31 MONITOR > Port Status > DDMI > DDMI Details

LABEL	DESCRIPTION
Transceiver Information	
Port No	This identifies the SFP port.
Connector Type	This displays the connector type of the optical transceiver.
Vendor	This displays the vendor name of the optical transceiver.
Part Number	This displays the part number of the optical transceiver.
Serial Number	This displays the serial number of the optical transceiver.
Revision	This displays the revision number of the optical transceiver.
Date Code	This displays the date when the optical transceiver was manufactured.
Transceiver	This displays details about the type of transceiver installed in the SFP slot.
DDMI Information	
Type	This displays the DDMI parameter.
Temperature (C/F)	This displays the temperature inside the SFP transceiver in degrees Celsius or Fahrenheit.
Voltage (V)	This displays the level of voltage being supplied to the SFP transceiver.
TX Bias (mA)	This displays the milliamps (mA) being supplied to the SFP transceiver's Laser Diode Transmitter.
TX Power (dbm)	This displays the amount of power the SFP transceiver is transmitting.
RX Power (dbm)	This displays the amount of power the SFP transceiver is receiving from the fiber cable.
Current	This displays the current status for each monitored DDMI parameter.
High Alarm Threshold	This displays the high value alarm threshold for each monitored DDMI parameter. An alarm signal is reported to the Switch if the monitored DDMI parameter reaches this value.
High Warn Threshold	This displays the high value warning threshold for each monitored DDMI parameter. A warning signal is reported to the Switch if the monitored DDMI parameter reaches this value.

Table 31 MONITOR > Port Status > DDMI > DDMI Details (continued)

LABEL	DESCRIPTION
Low Warn Threshold	This displays the low value warning threshold for each monitored DDMI parameter. A warning signal is reported to the Switch if the monitored DDMI parameter reaches this value.
Low Alarm Threshold	This displays the low value alarm threshold for each monitored DDMI parameter. An alarm signal is reported to the Switch if the monitored DDMI parameter reaches this value.

14.3 Port Utilization

This screen displays the percentage of actual transmitted or received frames on a port as a percentage of the **Link** speed. To view port utilization, click **MONITOR > Port Status > Port Utilization** to see the following screen. Alternatively, click **DASHBOARD** from any Web Configurator screen and then the **Port Status** link in the **Quick Link** section of the **DASHBOARD** screen to display the **Port Status** screen and then click the **Port Utilization** link tab.

Figure 82 MONITOR > Port Status > Port Utilization

Port	Link	Tx kB/s	Tx utilization%	Rx kB/s	Rx utilization%
1	Down	0.0	0.0	0.0	0.0
2	Down	0.0	0.0	0.0	0.0
3	Down	0.0	0.0	0.0	0.0
4	1G/F	0.824	0.0	0.347	0.0
5	Down	0.0	0.0	0.0	0.0
6	Down	0.0	0.0	0.0	0.0
7	Down	0.0	0.0	0.0	0.0

The following table describes the labels in this screen.

Table 32 MONITOR > Port Status > Port Utilization

LABEL	DESCRIPTION
Port	This identifies the Ethernet port.
Link	This field displays the speed (either 10M for 10 Mbps, 100M for 100 Mbps, or 1G for 1 Gbps) and the duplex (F for full duplex). It also shows the cable type (Copper or Fiber) for the combo ports. This field displays Down if the port is not connected to any device.
Tx kB/s	This field shows the transmission speed of data sent on this port in kilobytes per second.
Tx Utilization%	This field shows the percentage of actual transmitted frames on this port as a percentage of the Link speed.
Rx kB/s	This field shows the transmission speed of data received on this port in kilobytes per second.
Rx Utilization%	This field shows the percentage of actual received frames on this port as a percentage of the Link speed.

CHAPTER 15

System Information

15.0.1 What You Can Do

Use the **System Information** screen (Section 15.1 on page 115) to view general system information and hardware status of the Switch.

15.1 System Information

In the navigation panel, click **MONITOR > System Information** to display the screen as shown. Use this screen to view general system information.

Figure 83 MONITOR > System Information

The screenshot shows the 'System Information' screen with the following sections:

- System Information:**
 - System Name: GS1350
 - Product Model: GS1350-26HP
 - ZyNOS F/W Version: V4.90(ABPL0)b2 | 09/27/2023
 - Ethernet Address: d8:ec:e5:cf:66:4c
 - CPU Utilization Current (%): 13.97
- Memory Utilization:**

Name	Total (byte)	Used (byte)	Utilization (%)
common	35381248	5129520	14
- Hardware Monitor:**

Temperature Unit: C F

Temperature (C)	Status	Current	MAX	MIN	Threshold
CPU/MAC	Normal	48.0	48.0	30.0	89.0

The following table describes the labels in this screen.

Table 33 MONITOR > System Information

LABEL	DESCRIPTION
System Information	
System Name	This displays the descriptive name of the Switch for identification purposes.
Product Model	This displays the product model of the Switch. Use this information when searching for firmware upgrade or looking for other support information in the website.
ZyNOS F/W Version	This displays the version number of the Switch 's current firmware including the date created.

Table 33 MONITOR > System Information (continued)

LABEL	DESCRIPTION
Ethernet Address	This refers to the Ethernet MAC (Media Access Control) address of the Switch.
CPU Utilization Current (%)	This displays the current percentage of CPU utilization.
Memory Utilization	
Memory utilization shows how much DRAM memory is available and in use. It also displays the current percentage of memory utilization.	
Name	This displays the name of the memory pool.
Total (byte)	This displays the total number of bytes in this memory pool.
Used (byte)	This displays the number of bytes being used in this memory pool.
Utilization (%)	This displays the percentage (%) of memory being used in this memory pool.
Hardware Monitor	
Temperature Unit	The Switch has temperature sensors that are capable of detecting and reporting if the temperature rises above the threshold. You may choose the temperature unit (Centigrade or Fahrenheit) in this field.
Temperature (C/F)	CPU / MAC refers to the location of the temperature sensor on the Switch printed circuit board.
Status	This field displays Normal for temperatures below the threshold and Error for those above.
Current	This shows the current temperature at this sensor.
MAX	This field displays the maximum temperature measured at this sensor.
MIN	This field displays the minimum temperature measured at this sensor.
Threshold	This field displays the upper temperature limit at this sensor.

CHAPTER 16

System Log

16.1 System Log Overview

A log message stores the system history information for viewing.

16.2 System Log

Click **MONITOR > System Log** in the navigation panel to open this screen. Use this screen to check current system logs.

Note: When a log reaches the maximum number of log messages, new log messages automatically overwrite existing log messages, starting with the oldest existing log message first.

Figure 84 MONITOR > System Log

The screenshot shows the 'System Log' interface. At the top, there is a title bar with 'System Log' in green. Below it is a scrollable list of log messages, each starting with a line number, a timestamp, and a description of the event. The messages include interface link speed changes, system configuration saves, authentication attempts, and system resets. At the bottom of the interface, there are three green buttons: 'Refresh', 'Clear', and 'Download'.

Line	Timestamp	Message
1	2022-02-22T02:13:36Z	WA interface: port 26 link speed and duplex mode autonegotiation
2	2022-02-22T02:13:15Z	WA interface: port 26 link speed and duplex mode autonegotiation
3	2022-02-22T02:12:59Z	WA interface: port 26 link speed and duplex mode autonegotiation
4	2022-02-22T02:11:40Z	WA interface: port 26 link speed and duplex mode autonegotiation
5	2022-02-22T02:11:24Z	WA interface: port 26 link speed and duplex mode autonegotiation
6	2022-02-22T02:09:59Z	IN system: Save system configuration 1 successfully
7	2022-02-22T02:09:56Z	IN system: Save system configuration
8	2022-02-22T02:09:44Z	IN authentication: HTTP(s) user admin login [IP address = 192.168.1.100]
9	2022-02-22T02:09:33Z	WA interface: port 26 link speed and duplex mode autonegotiation
10	2022-02-22T02:09:17Z	WA interface: port 26 link speed and duplex mode autonegotiation
11	2022-02-22T02:07:58Z	WA interface: port 26 link speed and duplex mode autonegotiation
12	2022-02-22T02:07:42Z	WA interface: port 26 link speed and duplex mode autonegotiation
13	2022-02-22T02:07:27Z	WA interface: port 26 link speed and duplex mode autonegotiation
14	2022-02-22T02:07:11Z	WA interface: port 26 link speed and duplex mode autonegotiation
15	2022-02-22T02:05:21Z	WA interface: port 26 link speed and duplex mode autonegotiation
16	2022-02-22T02:05:04Z	WA interface: port 26 link speed and duplex mode autonegotiation
17	2022-02-22T02:04:16Z	WA interface: port 26 link speed and duplex mode autonegotiation
18	2022-02-22T02:04:00Z	WA interface: port 26 link speed and duplex mode autonegotiation
19	2022-02-22T02:02:42Z	WA interface: port 26 link speed and duplex mode autonegotiation
20	2022-02-22T02:02:25Z	IN authentication: HTTP(s) user admin login [IP address = 192.168.1.100]
21	2022-02-22T02:02:10Z	NO system: Gets the time and date from a time server successfully
22	2022-02-22T02:01:54Z	IN authentication: HTTP(s) user admin login [IP address = 192.168.1.100]
23	2022-02-22T02:01:07Z	DE interface: Port 28 link up 2.5G/F
24	2022-02-22T02:00:50Z	DE interface: Port 24 link up 2.5G/F
25	2022-02-22T01:59:31Z	DE interface: Port 18 link up 1G/F
26	2022-02-22T01:59:15Z	NO system: System warm start
27	2022-02-22T01:59:00Z	IN system: Image 1 F/W version V4.80 (ABML.0)0208datecode 02/02/2022
28	2022-02-22T01:58:43Z	NO system: System has reset due to a management command

The summary table shows the time the log message was recorded and the reason the log message was generated. Click **Refresh** to update this screen. Click **Clear** to clear the whole log, regardless of what is currently displayed on the screen. Click **Download** to save the log to your computer.

CHAPTER 17

SYSTEM

The following chapters introduces the configurations of the links under the **SYSTEM** navigation panel.

Quick links to chapters:

- [Cloud Management](#)
- [General Setup](#)
- [Interface Setup](#)
- [IP Setup](#)
- [IPv6](#)
- [Logins](#)
- [SNMP](#)
- [Switch Setup](#)
- [Syslog Setup](#)
- [Time Range](#)

CHAPTER 18

Cloud Management

18.1 Cloud Management Overview

The Zyxel Nebula Control Center (NCC) is a cloud-based network management system that allows you to remotely manage and monitor Zyxel Nebula APs, Ethernet switches and security gateways.

The Switch is managed and provisioned automatically by the NCC (Nebula Control Center) when:

- It is connected to the Internet.
- The **Nebula Control Center (NCC) Discovery** feature is enabled.
- It has been registered in the NCC.

18.2 Nebula Center Control Discovery

Click **SYSTEM > Cloud Management** to display this screen.

Figure 85 SYSTEM > Cloud Management

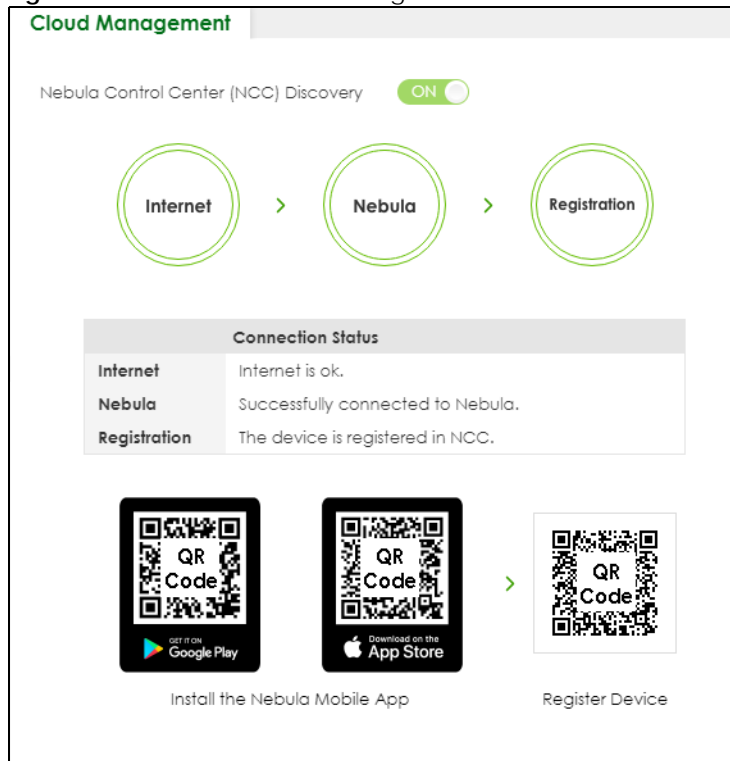

The following table describes the labels in this screen.

Table 34 SYSTEM > Cloud Management

LABEL	DESCRIPTION
Nebula Control Center (NCC) Discovery	<p>Enable the switch button to turn on Nebula Control Center (NCC) discovery on the Switch.</p> <p>This field displays:</p> <ul style="list-style-type: none"> • The Switch Internet connection status. • The connection status between the Switch and NCC. • The Switch registration status on NCC. <p>To pass your Switch management to NCC, first make sure your Switch is connected to the Internet. Then go to NCC and register your Switch.</p> <p>1. Internet</p> <p>Green – The Switch is connected to the Internet. Orange – The Switch is not connected to the Internet.</p> <p>2. Nebula</p> <p>Green – The Switch is connected to NCC. Orange – The Switch is not connected to NCC.</p> <p>3. Registration</p> <p>Green – The Switch is registered on NCC. Gray – The Switch is not registered on NCC.</p> <p>Note: All circles will gray out if you disable Nebula Discovery.</p>
Connection Status	<p>This table displays the NCC connection status information.</p> <p>Use status logs in the Internet, Nebula, and Registration fields for connection troubleshooting.</p>

Cloud Management Mode

Enable the switch button to turn on NCC discovery on the Switch. If the Switch has Internet access and has been registered on the NCC, it will automatically go into cloud management mode. Follow the steps to register your Switch on NCC:

1 Download the Nebula Mobile App

First, download the app from the Google Play store for Android devices or the App Store for iOS devices and create an organization and site.

You can scan an app store QR code to open the app installation page on the app store.

2 Scan the Device QR code

The **Register Device** QR code in this screen contains the Switch's serial number and the registration MAC address for handy NCC registration of the Switch using the Nebula Mobile app.

Follow the wizard in the Nebula Mobile app to scan the QR code to register the Switch on NCC and add the Switch into a site.

If **Nebula Control Center (NCC) Discovery** is disabled, the Switch will NOT discover the NCC and remain in Standalone mode.

CHAPTER 19

General Setup

19.1 General Setup

Use this screen to configure general settings such as the system name and time. Click **SYSTEM > General Setup** in the navigation panel to display the screen as shown.

Figure 86 SYSTEM > General Setup

Note: The input string of any field in this screen should not contain [?], [|], ['], ["], or [,].

The following table describes the labels in this screen.

Table 35 SYSTEM > General Setup

LABEL	DESCRIPTION
System Name	Choose a descriptive name for identification purposes. This name consists of up to 64 printable ASCII characters; spaces are allowed.
Location	Enter the geographic location of your Switch. You can use up to 128 printable ASCII characters; spaces are allowed.
Contact Person's Name	Enter the name of the person in charge of this Switch. You can use up to 32 printable ASCII characters; spaces are allowed.

Table 35 SYSTEM > General Setup (continued)

LABEL	DESCRIPTION
Use Time Server when Bootup	<p>Enter the time service protocol that your time server uses. Not all time servers support all protocols, so you may have to use trial and error to find a protocol that works. The main differences between them are the time format.</p> <p>When you select the Daytime (RFC-867) format, the Switch displays the day, month, year and time with no time zone adjustment. When you use this format it is recommended that you use a Daytime timeserver within your geographical time zone.</p> <p>Time (RFC-868) format displays a 4-byte integer giving the total number of seconds since 1970/1/1 at 00:00:00.</p> <p>NTP (RFC-1305) is similar to Time (RFC-868).</p> <p>None is the default value. Enter the time manually. Each time you turn on the Switch, the time and date will be reset to 2022-01-01 00:00:00.</p>
Time Server IP Address	Enter the IP address or domain name of your timeserver. The Switch searches for the timeserver for up to 60 seconds.
Time Server Sync Interval	Enter the period in minutes between each time server synchronization. The Switch checks the time server after every synchronization interval.
Current Time	This field displays the time you open this menu (or refresh the menu).
New Time (hh:mm:ss)	Enter the new time in hour, minute and second format. The new time then appears in the Current Time field after you click Apply .
Current Date	This field displays the date you open this menu.
New Date (yyyy-mm-dd)	Enter the new date in year, month and day format. The new date then appears in the Current Date field after you click Apply .
Time Zone	Select the time difference between UTC (Universal Time Coordinated, formerly known as GMT, Greenwich Mean Time) and your time zone from the drop-down list box.
Daylight Saving Time	<p>Daylight saving is a period from late spring to early fall when many countries set their clocks ahead of normal local time by one hour to give more daytime light in the evening.</p> <p>Enable the switch button if you use Daylight Saving Time.</p>
Start Date	<p>Configure the day and time when Daylight Saving Time starts if you selected Daylight Saving Time. The time is displayed in the 24 hour format. Here are a couple of examples:</p> <p>Daylight Saving Time starts in most parts of the United States on the second Sunday of March. Each time zone in the United States starts using Daylight Saving Time at 2 A.M. local time. So in the United States you would select Second, Sunday, March and 2:00.</p> <p>Daylight Saving Time starts in the European Union on the last Sunday of March. All of the time zones in the European Union start using Daylight Saving Time at the same moment (1 A.M. GMT or UTC). So in the European Union you would select Last, Sunday, March and the last field depends on your time zone. In Germany for instance, you would select 2:00 because Germany's time zone is one hour ahead of GMT or UTC (GMT+1).</p>
End Date	<p>Configure the day and time when Daylight Saving Time ends if you selected Daylight Saving Time. The time field uses the 24 hour format. Here are a couple of examples:</p> <p>Daylight Saving Time ends in the United States on the first Sunday of November. Each time zone in the United States stops using Daylight Saving Time at 2 A.M. local time. So in the United States you would select First, Sunday, November and 2:00.</p> <p>Daylight Saving Time ends in the European Union on the last Sunday of October. All of the time zones in the European Union stop using Daylight Saving Time at the same moment (1 A.M. GMT or UTC). So in the European Union you would select Last, Sunday, October and the last field depends on your time zone. In Germany for instance, you would select 2:00 because Germany's time zone is one hour ahead of GMT or UTC (GMT+1).</p>

Table 35 SYSTEM > General Setup (continued)

LABEL	DESCRIPTION
Apply	Click Apply to save your changes to the Switch's run-time memory. The Switch loses these changes if it is turned off or loses power, so use the Save link on the top navigation panel to save your changes to the non-volatile memory when you are done configuring.
Cancel	Click Cancel to begin configuring this screen afresh.

CHAPTER 20

Interface Setup

20.1 Interface Setup Overview

This chapter shows you how to create virtual interfaces for interface-based configurations. An IPv6 address is configured on a per-interface basis. The interface can be a physical interface (for example, an Ethernet port) or a virtual interface (for example, a VLAN).

20.2 Interface Setup

Use this screen to view and set IPv6 interfaces on which you can configure an IPv6 address to access and manage the Switch.

The interfaces you create here will only take effect after you configure them in the **SYSTEM > IPv6** screens.

Click **SYSTEM > Interface Setup** in the navigation panel to display the configuration screen.

Figure 87 SYSTEM > Interface Setup

<input type="checkbox"/>	Index	Interface Type	Interface ID	Interface
<input checked="" type="checkbox"/>	1	VLAN	1	VLAN1

The following table describes the labels in this screen.

Table 36 SYSTEM > Interface Setup

LABEL	DESCRIPTION
Index	This field displays the index number of an entry.
Interface Type	This field displays the type of interface.
Interface ID	This field displays the identification number of the interface.
Interface	This field displays the interface's descriptive name which is generated automatically by the Switch. The name is from a combination of the interface type and ID number.
	Select an entry's checkbox to select a specific entry. Otherwise, select the checkbox in the table heading row to select all entries.
Add/Edit	Click Add/Edit to add a new interface or edit a selected one.
Delete	Click Delete to remove the selected interfaces.

20.2.1 Add/Edit Interfaces

Click **Add/Edit**, or select an entry and click **Add/Edit** in the **SYSTEM > Interface Setup** screen to display the configuration screen.

Figure 88 SYSTEM > Interface Setup > Add/Edit

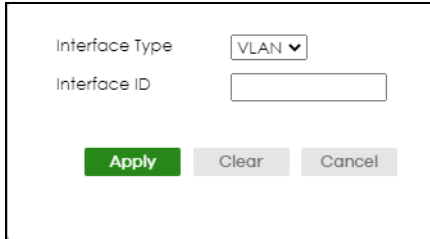

The following table describes the labels in this screen.

Table 37 SYSTEM > Interface Setup > Add/Edit

LABEL	DESCRIPTION
Interface Type	Select the type of IPv6 interface for which you want to configure. The Switch supports the VLAN interface type for IPv6 at the time of writing.
Interface ID	Specify a unique identification number (from 1 to 4094) for the interface. To have IPv6 function properly, you should configure a static VLAN with the same ID number in the SWITCHING > VLAN screens.
Apply	Click Apply to save your changes to the Switch's run-time memory. The Switch loses these changes if it is turned off or loses power, so use the Save link on the top navigation panel to save your changes to the non-volatile memory when you are done configuring.
Clear	Click Clear to clear the fields to the factory defaults.
Cancel	Click Cancel to not save the configuration you make and return to the last screen.

CHAPTER 21

IP Setup

21.1 IP Setup Overview

This chapter shows you how to configure IP settings and set up IP interfaces on the Switch using the **IP Setup** screens.

21.1.1 What You Can Do

- Use the **IP Status** screen ([Section 21.2 on page 127](#)) to view the current IP interfaces and DNS server settings on the Switch.
- Use the **IP Setup** screen ([Section 21.3 on page 129](#)) to configure the default gateway device, the default domain name server and add IP domains.
- Use the **Network Proxy Configuration** screen ([Section 21.4 on page 131](#)) to configure network proxy configurations.

21.1.2 IP Interfaces

The Switch needs an IP address for it to be managed over the network. When the Switch (in Standalone mode) fails to obtain an IP address from a DHCP server, the default static IP address 192.168.1.1 will be automatically added and used as the Switch's management IP address. The subnet mask specifies the network number portion of an IP address. The factory default subnet mask is 255.255.255.0.

On the Switch, an IP address is not bound to any physical ports. Since each IP address on the Switch must be in a separate subnet, the configured IP address is also known as IP interface (or routing domain). In addition, this allows routing between subnets based on the IP address without additional routers.

You can configure multiple routing domains on the same VLAN as long as the IP address ranges for the domains do not overlap. To change the IP address of the Switch in a routing domain, simply add a new routing domain entry with a different IP address in the same subnet.

You can configure up to 64 IP domains which are used to access and manage the Switch from the ports belonging to the pre-defined VLANs.

Note: You must configure a VLAN first. Each VLAN can have multiple management IP addresses, and you can log into the Switch through different management IP addresses simultaneously.

21.2 IP Status

Click **SYSTEM > IP Setup > IP Status** to display the screen as shown.

Figure 89 SYSTEM > IP Setup > IP Status

IP Status																								
IP Status		IP Setup		Network Proxy Configuration																				
Domain Name Server																								
<table border="1"> <thead> <tr> <th>Domain Name Server</th> <th>Source</th> </tr> </thead> <tbody> <tr> <td>172.21.10.1</td> <td>DHCPv4</td> </tr> </tbody> </table>							Domain Name Server	Source	172.21.10.1	DHCPv4														
Domain Name Server	Source																							
172.21.10.1	DHCPv4																							
IP Interface																								
<table border="1"> <thead> <tr> <th>Index</th> <th>IP Address</th> <th>IP Subnet Mask</th> <th>VID</th> <th>Type</th> <th>Action</th> </tr> </thead> <tbody> <tr> <td>1</td> <td>192.168.2.115</td> <td>255.255.255.0</td> <td>100</td> <td>Static</td> <td></td> </tr> <tr> <td>2</td> <td>172.21.40.22</td> <td>255.255.252.0</td> <td>1</td> <td>DHCP</td> <td> <input type="button" value="Renew"/> <input type="button" value="Release"/> </td> </tr> </tbody> </table>							Index	IP Address	IP Subnet Mask	VID	Type	Action	1	192.168.2.115	255.255.255.0	100	Static		2	172.21.40.22	255.255.252.0	1	DHCP	<input type="button" value="Renew"/> <input type="button" value="Release"/>
Index	IP Address	IP Subnet Mask	VID	Type	Action																			
1	192.168.2.115	255.255.255.0	100	Static																				
2	172.21.40.22	255.255.252.0	1	DHCP	<input type="button" value="Renew"/> <input type="button" value="Release"/>																			

The following table describes the labels in this screen.

Table 38 SYSTEM > IP Setup > IP Status

LABEL	DESCRIPTION
Domain Name Server	
Domain Name Server	This field displays the IP address of the DNS server.
Source	This field displays whether the DNS server address is configured manually (Static) or obtained automatically using DHCPv4 .
IP Interface	
Index	This field displays the index number of an entry.
IP Address	This field displays the IP address of the Switch in the IP domain.
IP Subnet Mask	This field displays the subnet mask of the Switch in the IP domain.
VID	This field displays the VLAN identification number of the IP domain on the Switch.
Type	This shows whether this IP address is dynamically assigned from a DHCP server (DHCP) or manually assigned (Static).
Renew	Click this to renew the dynamic IP address.
Release	Click this to release the dynamic IP address.

21.2.1 IP Status Details

Use this screen to view IP status details. Click a number in the **Index** column in the **SYSTEM > IP Setup > IP Status** screen to display the screen as shown next.

Figure 90 SYSTEM > IP Setup > IP Status > IP Status Details: Static

IP Status	IP Setup	Network Proxy Configuration
IP Status > IP Status Details		
IP Status Details		
Type	Static	
VID	100	
IP Address	192.168.2.115	
IP Subnet Mask	255.255.255.0	

The following table describes the labels in this screen.

Table 39 SYSTEM > IP Setup > IP Status > IP Status Details: Static

LABEL	DESCRIPTION
Type	This shows the IP address is manually assigned (Static).
VID	This is the VLAN identification number to which an IP routing domain belongs.
IP Address	This is the IP address of your Switch in dotted decimal notation for example 192.168.1.1.
IP Subnet Mask	This is the IP subnet mask of your Switch in dotted decimal notation for example 255.255.255.0.

Figure 91 SYSTEM > IP Setup > IP Status > IP Status Details: DHCP

IP Status	IP Setup	Network Proxy Configuration
IP Status > IP Status Details		
IP Status Details		
Type	DHCP	
VID	1	
IP Address	192.168.1.100	
IP Subnet Mask	255.255.255.0	
Lease Time	172800 seconds	
Renew Time	86400 seconds	
Rebind Time	138240 seconds	
Lease Time Start	2022-01-01 03:57:48	
Lease Time End	2022-01-03 03:57:48	
Default Gateway	192.168.1.250	
Primary DNS Server	192.168.1.254	
Secondary DNS Server	0.0.0.0	

The following table describes the labels in this screen.

Table 40 SYSTEM > IP Setup > IP Status > IP Status Details: DHCP

LABEL	DESCRIPTION
Type	This shows the IP address is dynamically assigned from a DHCP server (DHCP).
VID	This is the VLAN identification number to which an IP routing domain belongs.
IP Address	This is the IP address of your Switch in dotted decimal notation for example 192.168.1.1.
IP Subnet Mask	This is the IP subnet mask of your Switch in dotted decimal notation for example 255.255.255.0.
Lease Time	This displays the length of time in seconds that this interface can use the current dynamic IP address from the DHCP server.

Table 40 SYSTEM > IP Setup > IP Status > IP Status Details: DHCP (continued)

LABEL	DESCRIPTION
Renew Time	This displays the length of time from the lease start that the Switch will request to renew its current dynamic IP address from the DHCP server.
Rebind Time	This displays the length of time from the lease start that the Switch will request to get any dynamic IP address from the DHCP server.
Lease Time Start	This displays the date and time that the current dynamic IP address assignment from the DHCP server began. You should configure date and time in SYSTEM > General Setup .
Lease Time End	This displays the date and time that the current dynamic IP address assignment from the DHCP server will end. You should configure date and time in SYSTEM > General Setup .
Default Gateway	This displays the IP address of the default gateway assigned by the DHCP server. 0.0.0.0 means no gateway is assigned.
Primary / Secondary DNS Server	This displays the IP address of the primary and secondary DNS servers assigned by the DHCP server. 0.0.0.0 means no DNS server is assigned.

21.3 IP Setup

Use this screen to configure the default gateway device, the default domain name server and add IP domains. Click **SYSTEM > IP Setup > IP Setup** in the navigation panel to display the screen as shown.

Note: The Switch allows you to set a static IP interface in the same subnet that already has a DHCP-assigned IP interface on the Switch. The Switch will use the static IP you set and the DHCP-assigned IP will be set to 0.0.0.0.

Figure 92 SYSTEM > IP Setup > IP Setup

The screenshot shows the IP Setup configuration page. At the top, there are three tabs: IP Status, IP Setup (selected), and Network Proxy Configuration. Below the tabs, there are three main sections:

- Domain Name Server:** Two input fields for Domain Name Server 1 and Domain Name Server 2.
- Default Management IP Address:**
 - DHCP Client:
 - Option-60:
 - Class-ID: Zyxel Corporation GS2
 - Static IP Address:
 - IP Address: 172.21.40.3
 - IP Subnet Mask: 255.255.252.0
 - Default Gateway: 172.21.43.254
- VID:** Input field with value 1.

At the bottom of the form, there are 'Apply' and 'Cancel' buttons. Below the form is a table for Management IP Address with columns: Index, IP Address, IP Subnet Mask, VID, and Default Gateway. The table is currently empty. There are 'Add/Edit' and 'Delete' buttons at the top right of the table area.

The following table describes the labels in this screen.

Table 41 SYSTEM > IP Setup > IP Setup

LABEL	DESCRIPTION
Domain Name Server	
Domain Name Server 1/2	Enter a domain name server IPv4 address in order to be able to use a domain name instead of an IP address.
Default Management IP Address	
Use these fields to create or edit IP routing domains on the Switch.	
DHCP Client	Select this option if you have a DHCP server that can assign the Switch an IP address, subnet mask, a default gateway IP address and a domain name server IP address automatically.
Option-60	DHCP Option 60 is used by the Switch for identification to the DHCP server using the VCI (Vendor Class Identifier) on the DHCP server. The Switch adds it in the initial DHCP discovery message that a DHCP client broadcasts in search of an IP address. The DHCP server can assign different IP addresses or options to clients with the specific VCI or reject the request from clients without the specific VCI. Select this and enter the device identity you want the Switch to add in the DHCP discovery frames that go to the DHCP server. This allows the Switch to identify itself to the DHCP server.
Class-ID	Enter a string of up to 32 printable ASCII characters to identify this Switch to the DHCP server. For example, Zyxel-TW. The string should not contain [?], [], ['], ["], or [.].
Static IP Address	Select this option if you do not have a DHCP server or if you wish to assign static IP address information to the Switch. You need to fill in the following fields when you select this option.
IP Address	Enter the IP address of your Switch in dotted decimal notation, for example, 172.21.40.x. This is the IP address of the Switch in an IP routing domain.
IP Subnet Mask	Enter the IP subnet mask of an IP routing domain in dotted decimal notation, for example, 255.255.252.0.
Default Gateway	Enter the IP address of the default outgoing gateway in dotted decimal notation, for example 172.21.43.254.
VID	Enter the VLAN identification number to which an IP routing domain belongs.
Apply	Click Apply to save your changes to the Switch's run-time memory. The Switch loses these changes if it is turned off or loses power, so use the Save link on the top navigation panel to save your changes to the non-volatile memory when you are done configuring.
Cancel	Click Cancel to reset the fields to your previous configuration.
Management IP Address	
	Select an entry's checkbox to select a specific entry. Otherwise, select the checkbox in the table heading row to select all entries.
Index	This field displays the index number of an entry.
IP Address	This field displays IP address of the Switch in the IP domain.
IP Subnet Mask	This field displays the subnet mask of the Switch in the IP domain.
VID	This field displays the VLAN identification number of the IP domain on the Switch.
Default Gateway	This field displays the IP address of the default outgoing gateway in dotted decimal notation.
Add/Edit	Click Add/Edit to add a new management port setting or edit a selected one.
Delete	Click Delete to remove the selected entry from the summary table. Note: Deleting all IP subnets locks you out of the Switch.

21.3.1 Add/Edit IP Interfaces

Use this screen to add or edit IP interfaces. Click **Add/Edit**, or select an entry and click **Add/Edit** in the **SYSTEM > IP Setup > IP Setup** screen to display this screen.

Figure 93 SYSTEM > IP Setup > IP Setup > Add/Edit

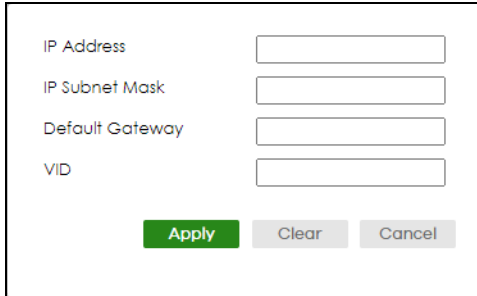

The following table describes the labels in this screen.

Table 42 SYSTEM > IP Setup > IP Setup > Add/Edit

LABEL	DESCRIPTION
IP Address	Enter the IP address of your Switch in dotted decimal notation, for example, 172.21.40.x. This is the IP address of the Switch in an IP routing domain.
IP Subnet Mask	Enter the IP subnet mask of an IP routing domain in dotted decimal notation, for example, 255.255.252.0.
Default Gateway	Enter the IP address of the default outgoing gateway in dotted decimal notation, for example 172.21.43.254.
VID	Enter the VLAN identification number to which an IP routing domain belongs.
Apply	Click Apply to save your changes to the Switch's run-time memory. The Switch loses these changes if it is turned off or loses power, so use the Save link on the top navigation panel to save your changes to the non-volatile memory when you are done configuring.
Clear	Click Clear to clear the fields to the factory defaults.
Cancel	Click Cancel to reset the fields to your previous configuration.

21.4 Network Proxy Configuration

The proxy server of an organization may prohibit communication between the Switch and NCC (Nebula Control Center) (See [Section 18.1 on page 119](#)). Use this screen to enable communication between the Switch and NCC through the proxy server.

Figure 94 Network Proxy Configuration Application

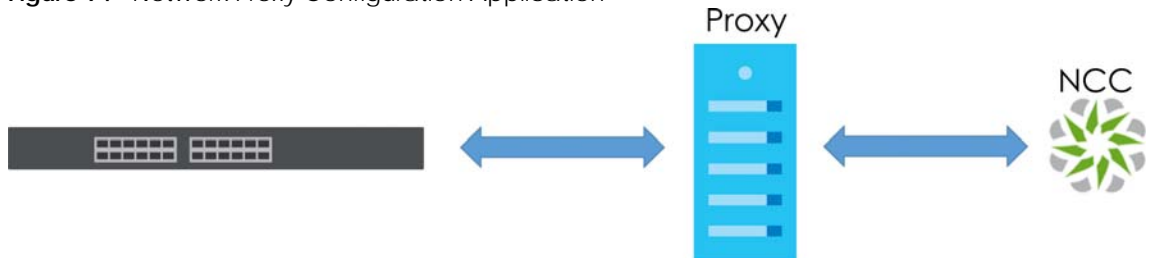

As of this writing, this setting only allows communication between the Switch and the NCC.

Figure 95 SYSTEM > IP Setup > Network Proxy Configuration

The following table describes the labels in this screen.

Table 43 SYSTEM > IP Setup > Network Proxy Configuration

LABEL	DESCRIPTION
Active	Enable the switch button to enable communication between the Switch and NCC through a proxy server.
Server	Enter the IP address (dotted decimal notation) or host name of the proxy server. When entering the host name, up to 128 alphanumeric characters are allowed for the Server except [?], [], ['], or ["].
Port	Enter the port number of the proxy server (1 – 65535).
Authentication	Enable the switch button to enable proxy server authentication using a Username and Password .
Username	Enter a login user name from the proxy server administrator. Up to 32 alphanumeric characters are allowed for the Username except [?], [], ['], or ["].
Password	Enter a login password from the proxy server administrator. Up to 32 alphanumeric characters are allowed for the Password except [?], [], ['], or ["].
Apply	Click Apply to save your changes to the Switch's run-time memory. The Switch loses these changes if it is turned off or loses power, so use the Save link on the top navigation panel to save your changes to the non-volatile memory when you are done configuring.
Cancel	Click Cancel to reset the fields to your previous configuration.

CHAPTER 22

IPv6

22.1 IPv6 Overview

This chapter introduces the **IPv6** screens.

- Use the **IPv6 Status** screen (Section 22.2 on page 133) to view the IPv6 table and DNS server information.
- Use the **IPv6 Global Setup** screen (Section 22.3 on page 136) to configure the global IPv6 settings.
- Use the **IPv6 Interface Setup** screen (Section 22.4 on page 137) to view and configure IPv6 interfaces.
- Use the **IPv6 Link-Local Address Setup** screen (Section 22.5 on page 138) to view and configure IPv6 link-local addresses.
- Use the **IPv6 Global Address Setup** screen (Section 22.6 on page 139) to view and configure IPv6 global addresses.
- Use the **IPv6 Neighbor Discovery Setup** screen (Section 22.7 on page 141) to view and configure neighbor discovery settings on each interface.
- Use the **IPv6 Neighbor Setup** screen (Section 22.8 on page 142) to configure static IPv6 neighbor entries in the Switch's IPv6 neighbor table.
- Use the **DHCPv6 Client Setup** screen (Section 22.9 on page 144) to configure the Switch's DHCP settings when it is acting as a DHCPv6 client.

22.2 IPv6 Status

Click **SYSTEM > IPv6 > IPv6 Status** in the navigation panel to display the IPv6 status screen as shown next.

Figure 96 SYSTEM > IPv6 > IPv6 Status

The screenshot shows the IPv6 Status screen with the following sections:

- IPv6 Status** (Header)
- Domain Name Server** (Section Header)
- Table with columns: Domain Name Server, Source
- IPv6 Table** (Section Header)
- Table with columns: Index, Interface, Active

Domain Name Server	Source

Index	Interface	Active
1	VLAN1	ON

The following table describes the labels in this screen.

Table 44 SYSTEM > IPv6 > IPv6 Status

LABEL	DESCRIPTION
Domain Name Server	
Domain Name Server	This field displays the IP address of the DNS server.
Source	This field displays whether the DNS server address is configured manually (Static) or obtained automatically using DHCPv6 .
IPv6 Table	
Index	This field displays the index number of an IPv6 interface. Click on an index number to view more interface details.
Interface	This is the name of the IPv6 interface you created.
Active	This field displays whether the IPv6 interface is activated or not.

22.2.1 IPv6 Interface Status Details

Use this screen to view a specific IPv6 interface status and detailed information. Click an interface index number in the **SYSTEM > IPv6 > IPv6 Status** screen. The following screen opens.

Figure 97 SYSTEM > IPv6 > IPv6 Status > IPv6 Interface Details

The screenshot shows the IPv6 Status page for interface VLAN1. At the top, there are two toggle switches: "Static IPv6 Active" (ON) and "DHCPv6 Client Active" (ON). Below these are two columns of configuration parameters. The left column includes MTU Size (1500), ICMPv6 Rate Limit Bucket Size (100), ICMPv6 Rate Limit Error Interval (1000), ND DAD Active (ON), Number of DAD Attempts (1), NS-interval (1000), ND Reachable Time (30000), Stateless Address Autoconfig (ON), Link-Local Address (fe80::be99:11ff:fe99:c60b/64 [preferred]), Global Unicast Address (ff01::1, ff02::1, ff02::1:ff99:c60b), and Joined Group Address. The right column includes Identity Association (IA Type: IA-NA, IAID: 11, T1: 0, T2: 0), State, SID, Address, Preferred Lifetime (0), Valid Lifetime (0), DNS, Domain List, and a Restart DHCPv6 Client button.

The following table describes the labels in this screen.

Table 45 SYSTEM > IPv6 > IPv6 Status > IPv6 Interface Details

LABEL	DESCRIPTION
Static IPv6 Active	
This field displays whether the IPv6 interface is activated or not.	
MTU Size	This field displays the Maximum Transmission Unit (MTU) size for IPv6 packets on this interface.
ICMPv6 Rate Limit Bucket Size	This field displays the maximum number of ICMPv6 error messages which are allowed to transmit in a given time interval. If the bucket is full, subsequent error messages are suppressed.

Table 45 SYSTEM > IPv6 > IPv6 Status > IPv6 Interface Details (continued)

LABEL	DESCRIPTION
ICMPv6 Rate Limit Error Interval	This field displays the time period (in milliseconds) during which ICMPv6 error messages of up to the bucket size can be transmitted. 0 means no limit.
ND DAD Active	This field displays whether Neighbor Discovery (ND) Duplicate Address Detection (DAD) is enabled on the interface.
Number of DAD Attempts	This field displays the number of consecutive neighbor solicitations the Switch sends for this interface.
NS-Interval (millisecond)	This field displays the time interval (in milliseconds) at which neighbor solicitations are re-sent for this interface.
ND Reachable Time (millisecond)	This field displays how long (in milliseconds) a neighbor is considered reachable for this interface.
Stateless Address Autoconfig	This field displays whether the Switch's interface can automatically generate a link-local address through stateless auto-configuration.
Link-Local Address	This field displays the Switch's link-local IP address and prefix generated by the interface. It also shows whether the IP address is preferred, which means it is a valid address and can be used as a sender or receiver address.
Global Unicast Address	This field displays the Switch's global unicast address to identify this interface.
Joined Group Address	This field displays the IPv6 multicast addresses of groups the Switch's interface joins.
DHCPv6 Client Active	
This field displays whether the Switch acts as a DHCPv6 client to get an IPv6 address from a DHCPv6 server.	
Identity Association	
An Identity Association (IA) is a collection of addresses assigned to a DHCP client, through which the server and client can manage a set of related IP addresses. Each IA must be associated with exactly one interface.	
IA Type	The IA type is the type of address in the IA. Each IA holds one type of address. IA_NA means an identity association for non-temporary addresses and IA_TA is an identity association for temporary addresses.
IAID	Each IA consists of a unique IAID and associated IP information.
T1	This field displays the DHCPv6 T1 timer. After T1, the Switch sends the DHCPv6 server a Renew message. An IA_NA option contains the T1 and T2 fields, but an IA_TA option does not. The DHCPv6 server uses T1 and T2 to control the time at which the client contacts with the server to extend the lifetimes on any addresses in the IA_NA before the lifetimes expire.
T2	This field displays the DHCPv6 T2 timer. If the time T2 is reached and the server does not respond, the Switch sends a Rebind message to any available server.
State	This field displays the state of the TA. It shows Active when the Switch obtains addresses from a DHCPv6 server and the TA is created. Renew when the TA's address lifetime expires and the Switch sends out a Renew message. Rebind when the Switch does not receive a response from the original DHCPv6 server and sends out a Rebind message to another DHCPv6 server.
SID	This field displays the DHCPv6 server's unique ID.
Address	This field displays the Switch's global address which is assigned by the DHCPv6 server.

Table 45 SYSTEM > IPv6 > IPv6 Status > IPv6 Interface Details (continued)

LABEL	DESCRIPTION
Preferred Lifetime	This field displays how long (in seconds) that the global address remains preferred.
Valid Lifetime	This field displays how long (in seconds) that the global address is valid.
DNS	This field displays the DNS server address assigned by the DHCPv6 server.
Domain List	This field displays the address record when the Switch queries the DNS server to resolve domain names.
Restart DHCPv6 Client	Click Restart to send a new DHCP request to the DHCPv6 server and update the IPv6 address and DNS information for this interface.

22.3 IPv6 Global Setup

Use this screen to configure the global IPv6 settings. Click **SYSTEM > IPv6 > IPv6 Global Setup** to display the screen as shown next.

Figure 98 SYSTEM > IPv6 > IPv6 Global Setup

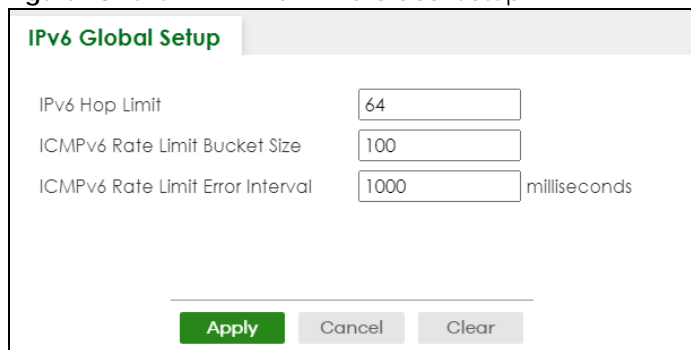

The following table describes the labels in this screen.

Table 46 SYSTEM > IPv6 > IPv6 Global Setup

LABEL	DESCRIPTION
IPv6 Hop Limit	Specify the maximum number of hops (from 1 to 255) in router advertisements. This is the maximum number of hops on which an IPv6 packet is allowed to transmit before it is discarded by an IPv6 router, which is similar to the TTL field in IPv4.
ICMPv6 Rate Limit Bucket Size	Specify the maximum number of ICMPv6 error messages (from 1 to 200) which are allowed to transmit in a given time interval. If the bucket is full, subsequent error messages are suppressed.
ICMPv6 Rate Limit Error Interval	Specify the time period (from 0 to 2147483647 milliseconds) during which ICMPv6 error messages of up to the bucket size can be transmitted. 0 means no limit.
Apply	Click Apply to save your changes to the Switch's run-time memory. The Switch loses these changes if it is turned off or loses power, so use the Save link on the top navigation panel to save your changes to the non-volatile memory when you are done configuring.
Cancel	Click Cancel to begin configuring this screen afresh.
Clear	Click Clear to reset the fields to the factory defaults.

22.4 IPv6 Interface Setup

Use this screen to view and configure an IPv6 interface you create in the **SYSTEM > Interface Setup** screen. Click **SYSTEM > IPv6 > IPv6 Interface Setup** to display the screen as shown next.

Figure 99 SYSTEM > IPv6 > IPv6 Interface Setup

Index	Interface	Active	Address Autoconfig
<input checked="" type="checkbox"/> 1	VLAN1	ON	ON

The following table describes the labels in this screen.

Table 47 SYSTEM > IPv6 > IPv6 Interface Setup

LABEL	DESCRIPTION
Index	This is the interface index number.
Interface	This is the name of the IPv6 interface you created.
Active	This field displays whether the IPv6 interface is activated or not.
Address Autoconfig	This field displays whether stateless auto-configuration is enabled on the interface.
	Select an entry's checkbox to select a specific entry.
Edit	Click Edit to edit the selected interface.

22.4.1 Edit an IPv6 Interface

Use this screen to turn on or off an IPv6 interface you create in the **SYSTEM > Interface Setup** screen. Select an entry and click **Edit** in the **SYSTEM > IPv6 > IPv6 Interface Setup** screen to display the screen as shown next.

Figure 100 SYSTEM > IPv6 > IPv6 Interface Setup > Edit

The following table describes the labels in this screen.

Table 48 SYSTEM > IPv6 > IPv6 Interface Setup > Edit

LABEL	DESCRIPTION
Interface	Select the IPv6 interface you want to configure.
Active	Enable the switch button to enable the interface.
Address Autoconfig	Select this option to allow the interface to automatically generate a link-local address through stateless auto-configuration.
Apply	Click Apply to save your changes to the Switch's run-time memory. The Switch loses these changes if it is turned off or loses power, so use the Save link on the top navigation panel to save your changes to the non-volatile memory when you are done configuring.

Table 48 SYSTEM > IPv6 > IPv6 Interface Setup > Edit (continued)

LABEL	DESCRIPTION
Clear	Click Clear to clear the fields to the factory defaults.
Cancel	Click Cancel to not save the configuration you make and return to the last screen.

22.5 IPv6 Link-Local Address Setup

A link-local address uniquely identifies a device on the local network (the LAN). It is similar to a “private IP address” in IPv4. You can have the same link-local address on multiple interfaces on a device. A link-local unicast address has a predefined prefix of fe80::/10.

Use this screen to view and configure the interface’s link-local address and default gateway. Click **SYSTEM > IPv6 > IPv6 Addressing > IPv6 Link-Local Address Setup** to display the screen as shown next.

Note: You should first create an IPv6 interface in the **SYSTEM > Interface Setup** screen.

Figure 101 SYSTEM > IPv6 > IPv6 Addressing > IPv6 Link-Local Address Setup



Index	Interface	IPv6 Link-Local Address	IPv6 Default Gateway
<input checked="" type="checkbox"/>	VLAN1		

The following table describes the labels in this screen.

Table 49 SYSTEM > IPv6 > IPv6 Addressing > IPv6 Link-Local Address Setup

LABEL	DESCRIPTION
Index	This is the interface index number.
Interface	This is the name of the IPv6 interface you created.
IPv6 Link-Local Address	This is the static IPv6 link-local address for the interface.
IPv6 Default Gateway	This is the default gateway IPv6 address for the interface.
	Select an entry’s checkbox to select a specific entry.
Edit	Click Edit to edit the selected entry.

22.5.1 Edit an IPv6 Link-Local Address

Use this screen to configure the link-local address and default gateway of an IPv6 interface you create in the **SYSTEM > Interface Setup** screen. Select an entry and click **Edit** in the **SYSTEM > IPv6 > IPv6 Addressing > IPv6 Link-Local Address Setup** screen to display this screen.

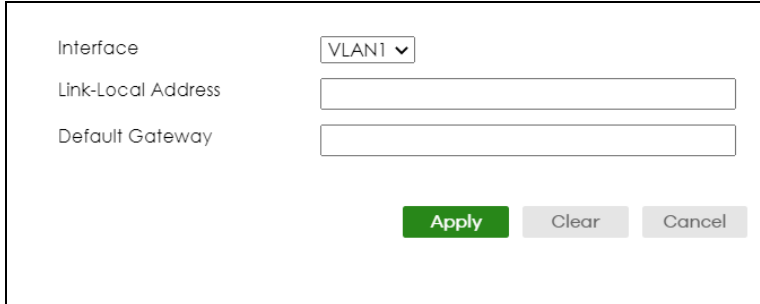
Figure 102 SYSTEM > IPv6 > IPv6 Addressing > IPv6 Link-Local Address Setup > Edit

The following table describes the labels in this screen.

Table 50 SYSTEM > IPv6 > IPv6 Addressing > IPv6 Link-Local Address Setup > Edit

LABEL	DESCRIPTION
Interface	Select the IPv6 interface you want to configure.
Link-Local Address	Manually configure a static IPv6 link-local address for the interface.
Default Gateway	Set the default gateway IPv6 address for the interface. When an interface cannot find a routing information for a frame's destination, it forwards the packet to the default gateway.
Apply	Click Apply to save your changes to the Switch's run-time memory. The Switch loses these changes if it is turned off or loses power, so use the Save link on the top navigation panel to save your changes to the non-volatile memory when you are done configuring.
Clear	Click Clear to clear the fields to the factory defaults.
Cancel	Click Cancel to not save the configuration you make and return to the last screen.

22.6 IPv6 Global Address Setup

Use this screen to view and configure the interface's IPv6 global address. Click **SYSTEM > IPv6 Addressing > IPv6 Global Address Setup** to display the screen as shown next.

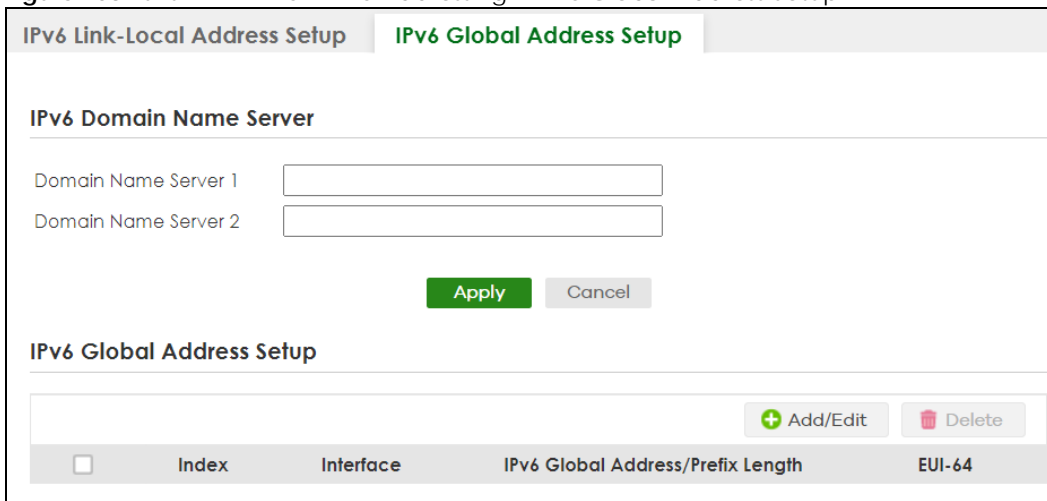
Figure 103 SYSTEM > IPv6 > IPv6 Addressing > IPv6 Global Address Setup

The following table describes the labels in this screen.

Table 51 SYSTEM > IPv6 > IPv6 Addressing > IPv6 Global Address Setup

LABEL	DESCRIPTION
IPv6 Domain Name Server	
Domain Name Server 1/2	Enter a domain name server IPv6 address in order to be able to use a domain name instead of an IP address.
Apply	Click Apply to save your changes to the Switch's run-time memory. The Switch loses these changes if it is turned off or loses power, so use the Save link on the top navigation panel to save your changes to the non-volatile memory when you are done configuring.
Cancel	Click this to reset the Domain Name Server values in this screen to their last-saved values.
IPv6 Global Address Setup	
Index	This is the interface index number.
Interface	This is the name of the IPv6 interface you created.
IPv6 Global Address/Prefix Length	This field displays the IPv6 global address and prefix length for the interface.
EUI-64	This shows whether the interface ID of the global address is generated using the EUI-64 format.
	Select an entry's checkbox to select a specific entry. Otherwise, select the checkbox in the table heading row to select all entries.
Add/Edit	Click Add/Edit to add a new entry or edit a selected one.
Delete	Click Delete to remove the selected entries.

22.6.1 Add/Edit an IPv6 Global Address

Use this screen to configure the interface's IPv6 global address. Click **Add/Edit**, or select an entry and click **Add/Edit** in the **SYSTEM > IPv6 Addressing > IPv6 Global Address Setup** screen to display this screen.

Figure 104 SYSTEM > IPv6 > IPv6 Addressing > IPv6 Global Address Setup > Add/Edit

The following table describes the labels in this screen.

Table 52 SYSTEM > IPv6 > IPv6 Addressing > IPv6 Global Address Setup > Add/Edit

LABEL	DESCRIPTION
Interface	Select the IPv6 interface you want to configure.
IPv6 Global Address	Manually configure a static IPv6 global address for the interface.
Prefix Length	Specify an IPv6 prefix length that specifies how many most significant bits (start from the left) in the address compose the network address.
EUI-64	Select this option to have the interface ID be generated automatically using the EUI-64 format.

Table 52 SYSTEM > IPv6 > IPv6 Addressing > IPv6 Global Address Setup > Add/Edit (continued)

LABEL	DESCRIPTION
Apply	Click Apply to save your changes to the Switch's run-time memory. The Switch loses these changes if it is turned off or loses power, so use the Save link on the top navigation panel to save your changes to the non-volatile memory when you are done configuring.
Clear	Click Clear to clear the fields to the factory defaults.
Cancel	Click Cancel to not save the configuration you make and return to the last screen.

22.7 IPv6 Neighbor Discovery Setup

Use this screen to configure neighbor discovery settings for each interface. Click **SYSTEM > IPv6 > IPv6 Neighbor Discovery > IPv6 Neighbor Discovery Setup** to display the screen as shown next.

Figure 105 SYSTEM > IPv6 > IPv6 Neighbor Discovery > IPv6 Neighbor Discovery Setup

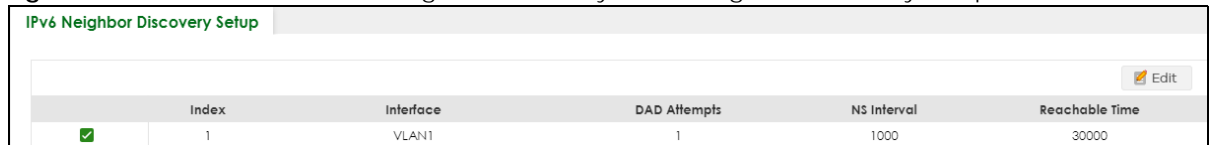

Index	Interface	DAD Attempts	NS Interval	Reachable Time
<input checked="" type="checkbox"/>	VLAN1	1	1000	30000

The following table describes the labels in this screen.

Table 53 SYSTEM > IPv6 > IPv6 Neighbor Discovery > IPv6 Neighbor Discovery Setup

LABEL	DESCRIPTION
Index	This is the interface index number.
Interface	This is the name of the IPv6 interface you created.
DAD Attempts	This field displays the number of consecutive neighbor solicitations the Switch sends for this interface.
NS Interval	This field displays the time interval (in milliseconds) at which neighbor solicitations are re-sent for this interface.
Reachable Time	This field displays how long (in milliseconds) a neighbor is considered reachable for this interface.
	Select an entry's checkbox to select a specific entry.
Edit	Click Edit to edit the selected entry.

22.7.1 Edit an IPv6 Neighbor Discovery

Use this screen to configure neighbor discovery settings for each interface. Select an entry and click **Edit** in the **SYSTEM > IPv6 > IPv6 Neighbor Discovery > IPv6 Neighbor Discovery Setup** screen to display this screen.

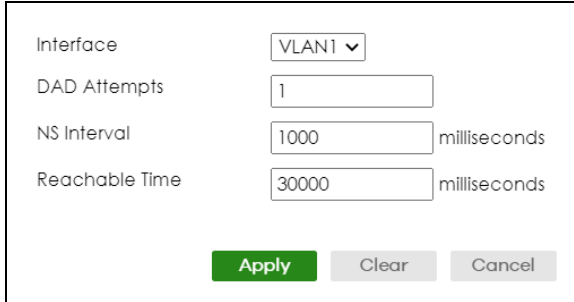
Figure 106 SYSTEM > IPv6 > IPv6 Neighbor Discovery > IPv6 Neighbor Discovery Setup > Edit

The following table describes the labels in this screen.

Table 54 SYSTEM > IPv6 > IPv6 Neighbor Discovery > IPv6 Neighbor Discovery Setup > Edit

LABEL	DESCRIPTION
Interface	Select the IPv6 interface you want to configure.
DAD Attempts	The Switch uses Duplicate Address Detection (DAD) with neighbor solicitation and advertisement messages to check whether an IPv6 address is already in use before assigning it to an interface. Specify the number of consecutive neighbor solicitations (from 0 to 600) the Switch sends for this interface. Enter 0 to turn off DAD.
NS Interval	Specify the time interval (from 1000 to 3600000 milliseconds) at which neighbor solicitations are re-sent for this interface.
Reachable Time	Specify how long (from 1000 to 3600000 milliseconds) a neighbor is considered reachable for this interface.
Apply	Click Apply to save your changes to the Switch's run-time memory. The Switch loses these changes if it is turned off or loses power, so use the Save link on the top navigation panel to save your changes to the non-volatile memory when you are done configuring.
Clear	Click Clear to clear the fields to the factory defaults.
Cancel	Click Cancel to not save the configuration you make and return to the last screen.

22.8 IPv6 Neighbor Setup

Use this screen to view and configure static IPv6 neighbor entries in the Switch's IPv6 neighbor table to store the neighbor information permanently. Click **SYSTEM > IPv6 > IPv6 Neighbor Setup** to display the screen as shown next.

Figure 107 SYSTEM > IPv6 > IPv6 Neighbor Setup

The following table describes the labels in this screen.

Table 55 SYSTEM > IPv6 > IPv6 Neighbor Setup

LABEL	DESCRIPTION
Index	This is the interface index number.
Interface	This is the name of the IPv6 interface you created.

Table 55 SYSTEM > IPv6 > IPv6 Neighbor Setup (continued)

LABEL	DESCRIPTION
Neighbor Address	This field displays the IPv6 address of the neighboring device which can be reached through the interface.
MAC	This field displays the MAC address of the neighboring device which can be reached through the interface.
	Select an entry's checkbox to select a specific entry. Otherwise, select the checkbox in the table heading row to select all entries.
Add/Edit	Click Add/Edit to add a new entry or edit a selected one.
Delete	Click Delete to remove the selected entries.

22.8.1 Add/Edit IPv6 Neighbor

Use this screen to create a static IPv6 neighbor entry. Click **Add/Edit**, or select an entry and click **Add/Edit** in the **SYSTEM > IPv6 > IPv6 Neighbor Setup** screen to display this screen.

Figure 108 SYSTEM > IPv6 > IPv6 Neighbor Setup > Add/Edit

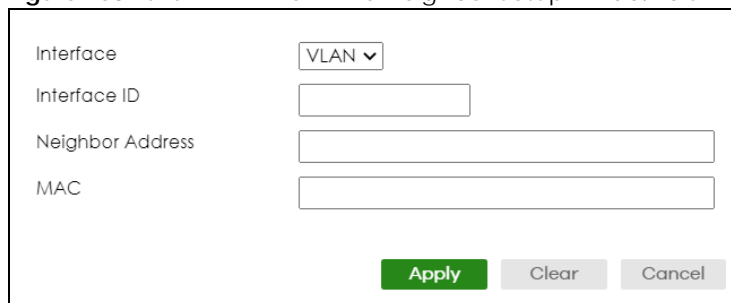

The following table describes the labels in this screen.

Table 56 SYSTEM > IPv6 > IPv6 Neighbor Setup > Add/Edit

LABEL	DESCRIPTION
Interface	Select the type of IPv6 interface for which you want to configure. The Switch supports the VLAN interface type for IPv6 at the time of writing.
Interface ID	Specify a unique identification number (from 1 to 4094) for the interface. A static IPv6 neighbor entry displays in the MONITOR > IPv6 Neighbor Table screen only when the interface ID is also created in the SYSTEM > Interface Setup screen. To have IPv6 function properly, you should configure a static VLAN with the same ID number in the SWITCHING > VLAN screens.
Neighbor Address	Specify the IPv6 address of the neighboring device which can be reached through the interface.
MAC	Specify the MAC address of the neighboring device which can be reached through the interface.
Apply	Click Apply to save your changes to the Switch's run-time memory. The Switch loses these changes if it is turned off or loses power, so use the Save link on the top navigation panel to save your changes to the non-volatile memory when you are done configuring.
Clear	Click Clear to clear the fields to the factory defaults.
Cancel	Click Cancel to not save the configuration you make and return to the last screen.

22.9 DHCPv6 Client Setup

Use this screen to configure the Switch's DHCP settings when it is acting as a DHCPv6 client. Click **SYSTEM > IPv6 > DHCPv6 Client Setup** to display the screen as shown next.

Figure 109 SYSTEM > IPv6 > DHCPv6 Client Setup

	Index	Interface	IA-NA	Rapid-Commit	DNS	Domain-List	Information Refresh Minimum
<input type="checkbox"/>	1	VLAN1	ON	OFF	OFF	OFF	86400
<input type="checkbox"/>	2	VLAN5	OFF	OFF	OFF	OFF	86400

The following table describes the labels in this screen.

Table 57 SYSTEM > IPv6 > DHCPv6 Client Setup

LABEL	DESCRIPTION
Index	This is the interface index number.
Interface	This is the name of the IPv6 interface you created.
IA-NA	This field displays whether the Switch obtains a non-temporary IP address from the DHCPv6 server.
Rapid-Commit	This field displays whether the Switch obtains information from the DHCPv6 server by a rapid two-message exchange.
DNS	This field displays whether the Switch obtains DNS server IPv6 addresses from the DHCPv6 server.
Domain-List	This field displays whether the Switch obtains a list of domain names from the DHCP server.
Information Refresh Minimum	This field displays the time interval (in seconds) at which the Switch exchanges other configuration information with a DHCPv6 server again.
	Select an entry's checkbox to select a specific entry.
Edit	Click Edit to edit the selected entry.

22.9.1 Edit DHCPv6 Client

Use this screen to configure the Switch's DHCP settings when it is acting as a DHCPv6 client. Select an entry and click **Edit** in the **SYSTEM > IPv6 > DHCPv6 Client Setup** screen to display this screen.

Figure 110 SYSTEM > IPv6 > DHCPv6 Client Setup > Edit

Interface: VLAN1

IA Type: IA-NA Rapid-Commit

Options: DNS Domain-List

Information Refresh Minimum: 86400 seconds

Buttons: Apply, Clear, Cancel

The following table describes the labels in this screen.

Table 58 SYSTEM > IPv6 > DHCPv6 Client Setup > Edit

LABEL	DESCRIPTION
Interface	Select the IPv6 interface you want to configure.
IA Type	<p>Select IA-NA to set the Switch to get a non-temporary IP address from the DHCPv6 server for this interface.</p> <p>Optionally, you can also select Rapid-Commit to have the Switch send its DHCPv6 Solicit message with a Rapid Commit option to obtain information from the DHCPv6 server by a rapid two-message exchange. The Switch discards any Reply messages that do not include a Rapid Commit option. The DHCPv6 server should also support the Rapid Commit option to have it work well.</p>
Options	Select DNS to have the Switch obtain DNS server IPv6 addresses and/or select Domain-List to have the Switch obtain a list of domain names from the DHCP server.
Information Refresh Minimum	Specify the time interval (from 600 to 4294967295 seconds) at which the Switch exchanges other configuration information with a DHCPv6 server again.
Apply	Click Apply to save your changes to the Switch's run-time memory. The Switch loses these changes if it is turned off or loses power, so use the Save link on the top navigation panel to save your changes to the non-volatile memory when you are done configuring.
Clear	Click Clear to clear the fields to the factory defaults.
Cancel	Click Cancel to not save the configuration you make and return to the last screen.

CHAPTER 23

Logins

23.1 Set Up Login Accounts

Up to five people (one administrator and four non-administrators) may access the Switch through Web Configurator at any one time.

- An administrator is someone who can both view and configure Switch changes. The user name for the Administrator is always **admin**. The default administrator password is **1234**.

Note: It is highly recommended that you change the default administrator password (**1234**).

- A non-administrator (user name is something other than **admin**) is someone who can view and/or configure Switch settings. The configuration right varies depending on the user's privilege level.

Click **SYSTEM > Logins** to view the screen as shown.

Figure 111 SYSTEM > Logins

Logins

Administrator

User Name

Old Password

New Password

Retype to confirm

⚠ Please record your new password whenever you change it. The system will lock you out if you have forgotten your password.

Edit Logins

Login	User Name	Password	Retype to confirm	Privilege
1	<input type="text"/>	<input type="text"/>	<input type="text"/>	<input type="text"/>
2	<input type="text"/>	<input type="text"/>	<input type="text"/>	<input type="text"/>
3	<input type="text"/>	<input type="text"/>	<input type="text"/>	<input type="text"/>
4	<input type="text"/>	<input type="text"/>	<input type="text"/>	<input type="text"/>

Apply **Cancel**

Note: The input string in any field of this screen should not contain [?], [|], ['], ["] or [,]. In the **Password** fields, [space] is also not allowed.

The following table describes the labels in this screen.

Table 59 SYSTEM > Logins

LABEL	DESCRIPTION
Administrator	
This is the default administrator account with the "admin" user name. You can change the default administrator user name.	
User Name	Change the default "admin" system user name (up to 32 printable ASCII characters except [?], [], ['], ["], or [,]).
Old Password	Enter the existing system password (1234 is the default password).
New Password	Enter your new system password. You can enter up to 32 printable ASCII characters.
Retype to confirm	Retype your new system password for confirmation. You can enter up to 32 printable ASCII characters.
Edit Logins	
You may configure passwords for up to four users. These users can have read-only or read/write access.	
Login	This is the index of an user account.
User Name	Set a user name (up to 32 printable ASCII characters except [?], [], ['], ["], or [,]).
Password	Enter your new system password.
Retype to confirm	Retype your new system password for confirmation.
Privilege	<p>Type the privilege level for this user. At the time of writing, users may have a privilege level of 0, 3, 13, or 14 representing different configuration rights as shown below.</p> <ul style="list-style-type: none"> • 0 – Display basic system information. • 3 – Display configuration or status. • 13 – Configure features except for login accounts, SNMP user accounts, the authentication method sequence and authorization settings, multiple logins, administrator and enable passwords, and configuration information display. • 14 – Configure login accounts, SNMP user accounts, the authentication method sequence and authorization settings, multiple logins, and administrator and enable passwords, and display configuration information. <p>Users can run command lines if the session's privilege level is greater than or equal to the command's privilege level. The session privilege initially comes from the privilege of the login account. For example, if the user has a privilege of 5, he or she can run commands that requires privilege level of 5 or less but not more.</p>
Apply	Click Apply to save your changes to the Switch's run-time memory. The Switch loses these changes if it is turned off or loses power, so use the Save link on the top navigation panel to save your changes to the non-volatile memory when you are done configuring.
Cancel	Click Cancel to begin configuring this screen afresh.

CHAPTER 24

SNMP

24.1 SNMP Overview

This chapter introduces the SNMP screens and shows you how to setup SNMP settings for management.

24.1.1 What You Can Do

- Use the **SNMP** screen ([Section 24.2 on page 148](#)) to configure general SNMP settings.
- Use the **SNMP User** screen ([Section 24.3 on page 150](#)) to create SNMP users for authentication with managers using SNMP v3 and associate them to SNMP groups.
- Use the **SNMP Trap Group** screen ([Section 24.4 on page 152](#)) to specify the types of SNMP traps that should be sent to each SNMP manager.
- Use the **SNMP Trap Port** screen ([Section 24.5 on page 153](#)) to enable/disable sending SNMP traps on a port.

24.2 Configure SNMP

Use this screen to configure your SNMP settings.

Click **SYSTEM** > **SNMP** to view the screen as shown.

Figure 112 SYSTEM > SNMP

SNMP SNMP User SNMP Trap Group SNMP Trap Port

General Setting

Version: v2c

Get Community: public

Set Community: public

Trap Community: public

Trap Destination

Index	Version	IP	Port	Username
1	v2c	0.0.0.0	162	
2	v2c	0.0.0.0	162	
3	v2c	0.0.0.0	162	
4	v2c	0.0.0.0	162	

Apply Cancel

Note: The string of any field in this screen should not contain [?], [|], ['], ["] or [,].

The following table describes the labels in this screen.

Table 60 SYSTEM > SNMP

LABEL	DESCRIPTION
General Setting	
Use this section to specify the SNMP version and community (password) values.	
Version	Select the SNMP version for the Switch. The SNMP version on the Switch must match the version on the SNMP manager. Choose SNMP version 2c (v2c), SNMP version 3 (v3) or both (v3v2c). SNMP version 2c is backwards compatible with SNMP version 1.
Get Community	Enter the Get Community string, which is the password for the incoming Get- and GetNext-requests from the management station. The Get Community string is only used by SNMP managers using SNMP version 2c or lower.
Set Community	Enter the Set Community string, which is the password for incoming Set- requests from the management station. The Set Community string is only used by SNMP managers using SNMP version 2c or lower.
Trap Community	Enter the Trap Community string, which is the password sent with each trap to the SNMP manager. The Trap Community string is only used by SNMP managers using SNMP version 2c or lower.
Trap Destination	
Use this section to configure where to send SNMP traps from the Switch.	
Index	This is the index of a trap destination.
Version	Specify the version of the SNMP trap messages.
IP	Enter the IP addresses of up to four managers to send your SNMP traps to.

Table 60 SYSTEM > SNMP (continued)

LABEL	DESCRIPTION
Port	Enter the port number upon which the manager listens for SNMP traps.
Username	Enter the user name to be sent to the SNMP manager along with the SNMP v3 trap. This user name must match an existing account on the Switch (configured in the SYSTEM > SNMP > SNMP User screen).
Apply	Click Apply to save your changes to the Switch's run-time memory. The Switch loses these changes if it is turned off or loses power, so use the Save link on the top navigation panel to save your changes to the non-volatile memory when you are done configuring.
Cancel	Click Cancel to begin configuring this screen afresh.

24.3 Configure SNMP User

Use this screen to create SNMP users for authentication with managers using SNMP v3 and associate them to SNMP groups. An SNMP user is an SNMP manager. Click **SYSTEM > SNMP > SNMP User** to view the screen as shown.

Figure 113 SYSTEM > SNMP > SNMP User

The following table describes the labels in this screen.

Table 61 SYSTEM > SNMP > SNMP User

LABEL	DESCRIPTION
Index	This is a read-only number identifying a login account on the Switch.
Username	This field displays the user name of a login account on the Switch.
Security Level	This field displays whether you want to implement authentication and/or encryption for SNMP communication with this user.
Authentication	This field displays the authentication algorithm used for SNMP communication with this user.
Privacy	This field displays the encryption method used for SNMP communication with this user.
Group	This field displays the SNMP group to which this user belongs.
	Select an entry's checkbox to select a specific entry. Otherwise, select the checkbox in the table heading row to select all entries.
Add/Edit	Click Add/Edit to add a new entry or edit a selected one.
Delete	Click Delete to remove the selected entries.

24.3.1 Add/Edit SNMP User

Use this screen to create SNMP users for authentication with managers using SNMP v3 and associate them to SNMP groups. An SNMP user is an SNMP manager. Click **Add/Edit**, or select an entry and click **Add/Edit** in the **SYSTEM > SNMP > SNMP User** screen to view the screen.

Note: Use the user name and password of the login accounts you specify in this screen to create accounts on the SNMP v3 manager.

Figure 114 SYSTEM > SNMP > SNMP User > Add/Edit

Username	<input type="text"/>		
Security Level	no auth ▾		
Authentication	MD5 ▾	Password	<input type="text"/>
Privacy	DES ▾	Password	<input type="text"/>
Group	admin ▾		
<input type="button" value="Apply"/> <input type="button" value="Clear"/> <input type="button" value="Cancel"/>			

The following table describes the labels in this screen.

Table 62 SYSTEM > SNMP > SNMP User > Add/Edit

LABEL	DESCRIPTION
Username	Specify the user name (up to 32 printable ASCII characters) of a login account on the Switch. The string should not contain [?], [], ['], ["] or [,].
Security Level	<p>Select whether you want to implement authentication and/or encryption for SNMP communication from this user. Choose:</p> <ul style="list-style-type: none"> no auth – to use the user name as the password string to send to the SNMP manager. This is equivalent to the Get, Set and Trap Community in SNMP v2c. This is the lowest security level. auth – to implement an authentication algorithm for SNMP messages sent by this user. priv – to implement authentication and encryption for SNMP messages sent by this user. This is the highest security level. <p>Note: The settings on the SNMP manager must be set at the same security level or higher than the security level settings on the Switch.</p>
Authentication	Select an authentication algorithm. MD5 (Message Digest 5) and SHA (Secure Hash Algorithm) are hash algorithms used to authenticate SNMP data. SHA authentication is generally considered stronger than MD5, but is slower.
Password	Enter the password of up to 32 printable ASCII characters (except [?], [], ['], ["], [space], or [,]) for SNMP user authentication.
Privacy	Specify the encryption method for SNMP communication from this user. You can choose one of the following: <ul style="list-style-type: none"> DES – Data Encryption Standard is a widely used (but breakable) method of data encryption. It applies a 56-bit key to each 64-bit block of data. AES – Advanced Encryption Standard is another method for data encryption that also uses a secret key. AES applies a 128-bit key to 128-bit blocks of data.
Password	Enter the password of up to 32 printable ASCII characters (except [?], [], ['], ["], [space], or [,]) for encrypting SNMP packets.
Group	<p>SNMP v3 adopts the concept of View-based Access Control Model (VACM) group. SNMP managers in one group are assigned common access rights to MIBs. Specify in which SNMP group this user is.</p> <p>admin – Members of this group can perform all types of system configuration, including the management of administrator accounts.</p> <p>read-write – Members of this group have read and write rights, meaning that the user can create and edit the MIBs on the Switch, except the user account and AAA configuration.</p> <p>read-only – Members of this group have read rights only, meaning the user can collect information from the Switch.</p>

Table 62 SYSTEM > SNMP > SNMP User > Add/Edit (continued)

LABEL	DESCRIPTION
Apply	Click Apply to save your changes to the Switch's run-time memory. The Switch loses these changes if it is turned off or loses power, so use the Save link on the top navigation panel to save your changes to the non-volatile memory when you are done configuring.
Clear	Click Clear to clear the fields to the factory defaults.
Cancel	Click Cancel to not save the configuration you make and return to the last screen.

24.4 SNMP Trap Group

Use this screen to specify the types of SNMP traps that should be sent to each SNMP manager. Click **SYSTEM > SNMP > SNMP Trap Group** to view the screen as shown.

Figure 115 SYSTEM > SNMP > SNMP Trap Group

The following table describes the labels in this screen.

Table 63 SYSTEM > SNMP > SNMP Trap Group

LABEL	DESCRIPTION
Trap Destination IP	Select one of your configured trap destination IP addresses. These are the IP addresses of the SNMP managers. You must first configure a trap destination IP address in the SYSTEM > SNMP > SNMP screen. Use the rest of the screen to select which traps the Switch sends to that SNMP manager.
Options	Select the individual SNMP traps that the Switch is to send to the SNMP station. The traps are grouped by category. Selecting a category in the heading row automatically selects all of the SNMP traps under that category. Clear the checkboxes for individual traps that you do not want the Switch to send to the SNMP station. Clearing a category's checkbox automatically clears all of the category's trap checkboxes (the Switch only sends traps from selected categories).
Apply	Click Apply to save your changes to the Switch's run-time memory. The Switch loses these changes if it is turned off or loses power, so use the Save link on the top navigation panel to save your changes to the non-volatile memory when you are done configuring.
Cancel	Click Cancel to begin configuring this screen afresh.

24.5 Enable or Disable Sending of SNMP Traps on a Port

Click **SYSTEM > SNMP > SNMP Trap Port** to view the screen as shown. Use this screen to set whether a trap received on the ports would be sent to the SNMP manager.

Figure 116 SYSTEM > SNMP > SNMP Trap Port

Port	Active
*	<input type="checkbox"/>
1	<input checked="" type="checkbox"/>
2	<input checked="" type="checkbox"/>
3	<input checked="" type="checkbox"/>
4	<input checked="" type="checkbox"/>
5	<input checked="" type="checkbox"/>
6	<input checked="" type="checkbox"/>
7	<input checked="" type="checkbox"/>

The following table describes the labels in this screen.

Table 64 SYSTEM > SNMP > SNMP Trap Port

LABEL	DESCRIPTION
Options	Select the trap type you want to configure here.
Port	This field displays a port number.
*	Settings in this row apply to all ports. Use this row only if you want to make some of the settings the same for all ports. Use this row first to set the common settings and then make adjustments on a port-by-port basis. Changes in this row are copied to all the ports as soon as you make them.
Active	Select this checkbox to enable the trap type of SNMP traps on this port. The Switch sends the related traps received on this port to the SNMP manager. Clear this checkbox to disable the sending of SNMP traps on this port.
Apply	Click Apply to save your changes to the Switch's run-time memory. The Switch loses these changes if it is turned off or loses power, so use the Save link on the top navigation panel to save your changes to the non-volatile memory when you are done configuring.
Cancel	Click Cancel to begin configuring this screen afresh.

24.6 Technical Reference

This section provides technical background information on the topics discussed in this chapter.

24.6.1 About SNMP

Simple Network Management Protocol (SNMP) is an application layer protocol used to manage and monitor TCP/IP-based devices. SNMP is used to exchange management information between the network management system (NMS) and a network element (NE). A manager station can manage and monitor the Switch through the network through SNMP version 1 (SNMPv1), SNMP version 2c or SNMP version 3. The next figure illustrates an SNMP management operation. SNMP is only available if TCP/IP is configured.

Figure 117 SNMP Management Model

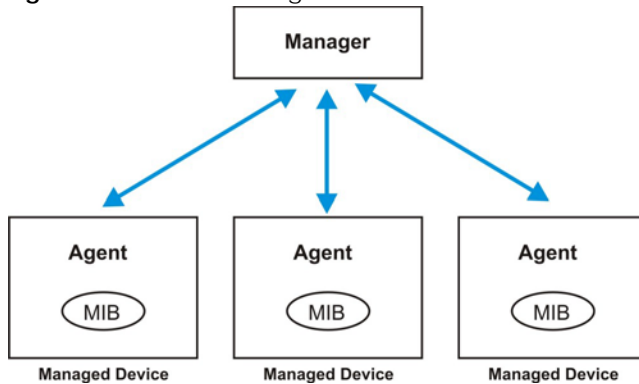

An SNMP managed network consists of two main components: agents and a manager.

An agent is a management software module that resides in a managed Switch (the Switch). An agent translates the local management information from the managed Switch into a form compatible with SNMP. The manager is the console through which network administrators perform network management functions. It executes applications that control and monitor managed devices.

The managed devices contain object variables or managed objects that define each piece of information to be collected about a Switch. Examples of variables include number of packets received, node port status, and so on. A Management Information Base (MIB) is a collection of managed objects. SNMP allows a manager and agents to communicate for the purpose of accessing these objects.

SNMP itself is a simple request or response protocol based on the manager or agent model. The manager issues a request and the agent returns responses using the following protocol operations:

Table 65 SNMP Commands

LABEL	DESCRIPTION
Get	Allows the manager to retrieve an object variable from the agent.
GetNext	Allows the manager to retrieve the next object variable from a table or list within an agent. In SNMPv1, when a manager wants to retrieve all elements of a table from an agent, it initiates a Get operation, followed by a series of GetNext operations.
Set	Allows the manager to set values for object variables within an agent.
Trap	Used by the agent to inform the manager of some events.

SNMP v3 and Security

SNMP v3 enhances security for SNMP management. SNMP managers can be required to authenticate with agents before conducting SNMP management sessions.

Security can be further enhanced by encrypting the SNMP messages sent from the managers.

Encryption protects the contents of the SNMP messages. When the contents of the SNMP messages are encrypted, only the intended recipients can read them.

Supported MIBs

A MIB is a collection of managed objects that is organized according to hierarchy. The objects define the attributes of the managed device, which includes the names, status, access rights, and data types. Each object can be addressed through an object identifier (OID). An OID that begins with "1.3.6.1.4.1.890.1.15" is a Zyxel-defined private MIB. Otherwise, it is a standard MIB OID.

MIBs let administrators collect statistics and monitor status and performance. The Switch uses both standard public (RFC-defined) MIBs for standard functionality, and private MIBs that support additional Switch functionality. Private MIBs contain Switch specific managed objects.

To view a list of standard MIBs supported by your Switch, see the product datasheet at www.zyxel.com (**Support > Download Library > Datasheet**).

To get the private MIBs supported by your Switch, download (and unzip) the correct model MIB from www.zyxel.com (**Support > Download Library > MIB File**).

SNMP Traps

The Switch sends traps to an SNMP manager when an event occurs. The following tables outline the SNMP traps by category.

Table 66 SNMP System Traps

OPTION	OBJECT LABEL	OBJECT ID	DESCRIPTION
coldstart	coldStart	1.3.6.1.6.3.1.1.5.1	This trap is sent when the Switch is turned on.
warmstart	warmStart	1.3.6.1.6.3.1.1.5.2	This trap is sent when the Switch restarts.
fanspeed	zyHwMonitorFanSpeedOutOfRange	1.3.6.1.4.1.890.1.15 .3.26.2.1	This trap is sent when the fan speed goes above or below the normal operating range.
	zyHwMonitorFANSpeedOutOfRangeRecovered	1.3.6.1.4.1.890.1.15 .3.26.2.6	This trap is sent when the fan speed is recovered from the out of range to normal operating range.
temperature	zyHwMonitorTemperatureOutOfRange	1.3.6.1.4.1.890.1.15 .3.26.2.2	This trap is sent when the temperature goes above or below the normal operating range.
	zyHwMonitorTemperatureOutOfRangeRecovered	1.3.6.1.4.1.890.1.15 .3.26.2.7	This trap is sent when the temperature is recovered from the out of range to normal operating range.
voltage	zyHwMonitorPowerSupplyVoltageOutOfRange	1.3.6.1.4.1.890.1.15 .3.26.2.3	This trap is sent when the voltage goes above or below the normal operating range.

Table 66 SNMP System Traps (continued)

OPTION	OBJECT LABEL	OBJECT ID	DESCRIPTION
reset	zySysMgmtUncontrolledSystemReset	1.3.6.1.4.1.890.1.15.3.49.2.1	This trap is sent when the Switch automatically resets.
	zySysMgmtControlledSystemReset	1.3.6.1.4.1.890.1.15.3.49.2.2	This trap is sent when the Switch resets by an administrator through a management interface.
	zySysMgmtBootImageInconsistence	1.3.6.1.4.1.890.1.15.3.49.2.3	This trap is sent when the index number of image which is loaded when the Switch starts up is different from what is specified through the CLI.
	RebootEvent	1.3.6.1.4.1.890.1.15.1.1.2	This trap is sent when the Switch reboots by an administrator through a management interface.
timesync	zyDateTimeTrapTimeServerNotReachable	1.3.6.1.4.1.890.1.15.3.82.3.1	This trap is sent when the Switch's date and time is not manually entered or the specified time server is not reachable.
	zyDateTimeTrapTimeServerNotReachableRecovered	1.3.6.1.4.1.890.1.15.3.82.3.2	This trap is sent when the Switch's real time clock is up to date.
intrusionlock	zyPortIntrusionLock	1.3.6.1.4.1.890.1.15.3.61.3.2	This trap is sent when intrusion lock occurs on a port.
loopguard	zyLoopGuardLoopDetect	1.3.6.1.4.1.890.1.15.3.45.2.1	This trap is sent when loopguard shuts down a port.
errdisable	zyErrdisableDetect	1.3.6.1.4.1.890.1.15.3.24.4.1	This trap is sent when an error is detected on a port, such as a loop occurs or the rate limit for specific control packets is exceeded.
	zyErrdisableRecovery	1.3.6.1.4.1.890.1.15.3.24.4.2	This trap is sent when the Switch ceases the action taken on a port, such as shutting down the port or discarding packets on the port, after the specified recovery interval.
	zyPoePowerPortOverload	1.3.6.1.4.1.890.1.15.3.59.4.1	This trap is sent when the port is turned off to supply power due to overloading.
	zyPoePowerPortShortCircuit	1.3.6.1.4.1.890.1.15.3.59.4.2	This trap is sent when the port is turned off to supply power due to short circuit.
	zyPoePowerPortOverSystemBudget	1.3.6.1.4.1.890.1.15.3.59.4.3	This trap is sent when the port is turned off to supply power because the requested power exceeds the total PoE power budget on the Switch.
	zyPoePowerPortOverloadRecovered	1.3.6.1.4.1.890.1.15.3.59.4.5	This trap is sent when the port is turned on to recover from an overloaded state.
	zyPoePowerPortShortCircuitRecovered	1.3.6.1.4.1.890.1.15.3.59.4.6	This trap is sent when the port is turned on to recover from a short circuit.
	zyPoePowerPortOverSystemBudgetRecovered	1.3.6.1.4.1.890.1.15.3.59.4.7	This trap is sent when the port is turned on to recover from an over system budget.
loginrecord	zyAccessControlLoginRecord	1.3.6.1.4.1.890.1.15.3.9.4.1	This trap is sent when users log in.
	zyAccessControlLogoutRecord	1.3.6.1.4.1.890.1.15.3.9.4.2	This trap is sent when users log out.
	zyAccessControlLoginFail	1.3.6.1.4.1.890.1.15.3.9.4.3	This trap is sent when users fail in login.

Table 67 SNMP Interface Traps

OPTION	OBJECT LABEL	OBJECT ID	DESCRIPTION
linkup	linkUp	1.3.6.1.6.3.1.1.5.4	This trap is sent when the Ethernet link is up.
linkdown	linkDown	1.3.6.1.6.3.1.1.5.3	This trap is sent when the Ethernet link is down.
lldp	lldpRemTablesChange	1.0.8802.1.1.2.0.0.1	The trap is sent when entries in the remote database have any updates. Link Layer Discovery Protocol (LLDP), defined as IEEE 802.1ab, enables LAN devices that support LLDP to exchange their configured settings. This helps eliminate configuration mismatch issues.
transceiver-ddm	zyTransceiverDdmiTemperatureOutOfRange	1.3.6.1.4.1.890.1.15.3.84.3.1	This trap is sent when the transceiver temperature is above or below the normal operating range.
	zyTransceiverDdmiTxPowerOutOfRange	1.3.6.1.4.1.890.1.15.3.84.3.2	This trap is sent when the transmitted optical power is above or below the normal operating range.
	zyTransceiverDdmiRxPowerOutOfRange	1.3.6.1.4.1.890.1.15.3.84.3.3	This trap is sent when the received optical power is above or below the normal operating range.
	zyTransceiverDdmiVoltageOutOfRange	1.3.6.1.4.1.890.1.15.3.84.3.4	This trap is sent when the transceiver supply voltage is above or below the normal operating range.
	zyTransceiverDdmiTxBiasOutOfRange	1.3.6.1.4.1.890.1.15.3.84.3.5	This trap is sent when the transmitter laser bias current is above or below the normal operating range.
	zyTransceiverDdmiTemperatureOutOfRangeRecovered	1.3.6.1.4.1.890.1.15.3.84.3.6	This trap is sent when the transceiver temperature is recovered from the out of normal operating range.
	zyTransceiverDdmiTxPowerOutOfRangeRecovered	1.3.6.1.4.1.890.1.15.3.84.3.7	This trap is sent when the transmitted optical power is recovered from the out of normal operating range.
	zyTransceiverDdmiRxPowerOutOfRangeRecovered	1.3.6.1.4.1.890.1.15.3.84.3.8	This trap is sent when the received optical power is recovered from the out of normal operating range.
	zyTransceiverDdmiVoltageOutOfRangeRecovered	1.3.6.1.4.1.890.1.15.3.84.3.9	This trap is sent when the transceiver supply voltage is recovered from the out of normal operating range.
	zyTransceiverDdmiTxBiasOutOfRangeRecovered	1.3.6.1.4.1.890.1.15.3.84.3.10	This trap is sent when the transmitter laser bias current is recovered from the out of normal operating range.
Storm-control	zyPortStormControlTrap	1.3.6.1.4.1.890.1.15.3.78.2.1	This trap is sent when storm control is detected on a specific port. A packet filter action has been applied on the interface.

Table 68 SNMP AAA Traps

OPTION	OBJECT LABEL	OBJECT ID	DESCRIPTION
authentication	zyRadiusServerAuthenticationServerNotReachable	1.3.6.1.4.1.890.1.15.3.71.2.1	This trap is sent when there is no response message from the RADIUS authentication server.
	zyRadiusServerAuthenticationServerNotReachableRecovered	1.3.6.1.4.1.890.1.15.3.71.2.3	This trap is sent when there is a response message from the previously unreachable RADIUS authentication server.
	zyAaaAuthenticationFailure	1.3.6.1.4.1.890.1.15.3.8.3.1	This trap is sent when authentication fails due to incorrect user name and/or password.
	authenticationFailure	1.3.6.1.6.3.1.1.5.5	This trap is sent when authentication fails due to incorrect user name and/or password.
authorization	zyAaaAuthorizationFailure	1.3.6.1.4.1.890.1.15.3.8.3.2	This trap is sent when management connection authorization failed.
accounting	zyRadiusServerAccountingServerNotReachable	1.3.6.1.4.1.890.1.15.3.71.2.2	This trap is sent when there is no response message from the RADIUS accounting server.
	zyRadiusServerAccountingServerNotReachableRecovered	1.3.6.1.4.1.890.1.15.3.71.2.4	This trap is sent when there is a response message from the previously unreachable RADIUS accounting server.

Table 69 SNMP IP Traps

OPTION	OBJECT LABEL	OBJECT ID	DESCRIPTION
ping	pingProbeFailed	1.3.6.1.2.1.80.0.1	This trap is sent when a single ping probe fails.
	pingTestFailed	1.3.6.1.2.1.80.0.2	This trap is sent when a ping test (consisting of a series of ping probes) fails.
	pingTestCompleted	1.3.6.1.2.1.80.0.3	This trap is sent when a ping test is completed.
traceroute	traceRouteTestFailed	1.3.6.1.2.1.81.0.2	This trap is sent when a traceroute test fails.
	traceRouteTestCompleted	1.3.6.1.2.1.81.0.3	This trap is sent when a traceroute test is completed.

Table 70 SNMP Switch Traps

OPTION	OBJECT LABEL	OBJECT ID	DESCRIPTION
stp	STPNewRoot	1.3.6.1.2.1.17.0.1	This trap is sent when the STP root switch changes.
	STPTopologyChange	1.3.6.1.2.1.17.0.2	This trap is sent when the STP topology changes.

Table 70 SNMP Switch Traps (continued)

OPTION	OBJECT LABEL	OBJECT ID	DESCRIPTION
mactable	zyMacForwardingTableFull	1.3.6.1.4.1.890.1.15 .3.48.2.1	This trap is sent when more than 99% of the MAC table is used.
	zyMacForwardingTableFullRecovered	1.3.6.1.4.1.890.1.15 .3.48.2.2	This trap is sent when the MAC address switching table has become normal from full.
rmon	RmonRisingAlarm	1.3.6.1.2.1.16.0.1	This trap is sent when a variable goes over the RMON "rising" threshold.
	RmonFallingAlarm	1.3.6.1.2.1.16.0.2	This trap is sent when the variable falls below the RMON "falling" threshold.

CHAPTER 25

Switch Setup

25.1 Switch Setup Overview

Use this screen to do the Switch's basic setup configuration, for example, VLAN (Virtual Local Area Network) type, enabling switching protocols, and MAC learning aging time setup.

25.1.1 Introduction to VLANs

A VLAN (Virtual Local Area Network) allows a physical network to be partitioned into multiple logical networks. Devices on a logical network belong to one group. A device can belong to more than one group. With VLAN, a device cannot directly talk to or hear from devices that are not in the same groups; the traffic must first go through a router.

In MTU (Multi-Tenant Unit) applications, VLAN is vital in providing isolation and security among the subscribers. When properly configured, VLAN prevents one subscriber from accessing the network resources of another on the same LAN, thus a user will NOT see the printers and hard disks of another user in the same building.

VLAN also increases network performance by limiting broadcasts to a smaller and more manageable logical broadcast domain. In traditional switched environments, all broadcast packets go to each and every individual port. With VLAN, all broadcasts are confined to a specific broadcast domain.

Note: VLAN is unidirectional; it only governs outgoing traffic.

25.2 Switch Setup

Click **SYSTEM** > **Switch Setup** in the navigation panel to display the screen as shown. The VLAN setup screens change depending on whether you choose **802.1Q** or **Port Based** in the **VLAN Type** field in this screen.

Figure 118 SYSTEM > Switch Setup

Switch Setup

VLAN Type 802.1Q Port Based

MAC Address Learning

Aging Time seconds

ARP Aging Time

Aging Time seconds

Apply **Cancel**

The following table describes the labels in this screen.

Table 71 SYSTEM > Switch Setup

LABEL	DESCRIPTION
VLAN Type	Choose 802.1Q or Port Based . The SWITCHING > VLAN link and its sub-links only appears when you choose 802.1Q VLAN type in this screen.
MAC Address Learning	
MAC address learning reduces outgoing traffic broadcasts. For MAC address learning to occur on a port, the port must be active.	
Aging Time	Enter a time from 10 to 1000000 seconds. This is how long all dynamically learned MAC addresses remain in the MAC address table before they age out (and must be relearned).
ARP Aging Time	
Aging Time	Enter a time from 60 to 1000000 seconds. This is how long dynamically learned ARP entries remain in the ARP table before they age out (and must be relearned). The setting here applies to ARP entries which are newly added in the ARP table after you click Apply .
Apply	Click Apply to save your changes to the Switch's run-time memory. The Switch loses these changes if it is turned off or loses power, so use the Save link on the top navigation panel to save your changes to the non-volatile memory when you are done configuring.
Cancel	Click Cancel to begin configuring this screen afresh.

CHAPTER 26

Syslog Setup

26.1 Syslog Overview

This chapter explains the **Syslog** screens.

The syslog protocol allows devices to send event notification messages across an IP network to syslog servers that collect the event messages. A syslog-enabled device can generate a syslog message and send it to a syslog server.

Syslog is defined in RFC 3164. The RFC defines the packet format, content and system log related information of syslog messages. Each syslog message has a facility and severity level. The syslog facility identifies a file in the syslog server. Refer to the documentation of your syslog program for details. The following table describes the syslog severity levels.

Table 72 Syslog Severity Levels

CODE	SEVERITY
0	Emergency: The system is unusable.
1	Alert: Action must be taken immediately.
2	Critical: The system condition is critical.
3	Error: There is an error condition on the system.
4	Warning: There is a warning condition on the system.
5	Notice: There is a normal but significant condition on the system.
6	Informational: The syslog contains an informational message.
7	Debug: The message is intended for debug-level purposes.

26.1.1 What You Can Do

Use the **Syslog Setup** screen ([Section 26.2 on page 162](#)) to configure the device's system logging settings and configure a list of external syslog servers.

26.2 Syslog Setup

The syslog feature sends logs to an external syslog server. Use this screen to configure the device's system logging settings and configure a list of external syslog servers.

Click **SYSTEM** > **Syslog Setup** in the navigation panel to display this screen.

Figure 119 SYSTEM > Syslog Setup

Syslog Setup

Active OFF

Logging Type	Active	Facility
System	<input type="checkbox"/>	local use 0 ▼
Interface	<input type="checkbox"/>	local use 0 ▼
Switch	<input type="checkbox"/>	local use 0 ▼
AAA	<input type="checkbox"/>	local use 0 ▼
IP	<input type="checkbox"/>	local use 0 ▼

Apply **Cancel**

Syslog Server Setup

+ Add/Edit **Delete**

<input type="checkbox"/>	Index	Active	IP Address	UDP Port	Log Level
--------------------------	-------	--------	------------	----------	-----------

The following table describes the labels in this screen.

Table 73 SYSTEM > Syslog Setup

LABEL	DESCRIPTION
Syslog Setup	
Active	Enable the switch button to turn on syslog (system logging) and then configure the syslog setting.
Logging Type	This column displays the names of the categories of logs that the device can generate.
Active	Select this option to set the device to generate logs for the corresponding category.
Facility	The log facility allows you to send logs to different files in the syslog server. Refer to the documentation of your syslog program for more details.
Apply	Click Apply to save your changes to the Switch's run-time memory. The Switch loses these changes if it is turned off or loses power, so use the Save link on the top navigation panel to save your changes to the non-volatile memory when you are done configuring.
Cancel	Click Cancel to begin configuring this screen afresh.
Syslog Server Setup	
Index	This is the index number of a syslog server entry.
Active	This field displays if the device is activated to send logs to the syslog server.
IP Address	This field displays the IP address of the syslog server.
UDP Port	This field displays the port of the syslog server.
Log Level	This field displays the severity level of the logs that the device is to send to this syslog server.
	Select an entry's checkbox to select a specific entry. Otherwise, select the checkbox in the table heading row to select all entries.
Add/Edit	Click Add/Edit to add a new entry or edit a selected one.
Delete	Click Delete to remove the selected entries.

26.2.1 Add/Edit a Syslog Server

Use this screen to configure an external syslog server.

Click **Add/Edit**, or select an entry and click **Add/Edit** in the **SYSTEM > Syslog Setup** screen to display this screen.

Figure 120 SYSTEM > Syslog Setup > Add/Edit

The following table describes the labels in this screen.

Table 74 SYSTEM > Syslog Setup > Add/Edit

LABEL	DESCRIPTION
Active	Enable the switch button to have the device send logs to this syslog server. Clear the checkbox if you want to create a syslog server entry but not have the device send logs to it (you can edit the entry later).
Server Address	Enter the IPv4 or IPv6 address of the syslog server.
UDP Port	The default syslog server port is 514. If your syslog server uses a different port, configure the one it uses here.
Log Level	Select the severity levels of the logs that you want the device to send to this syslog server. The lower the number, the more critical the logs are.
Apply	Click Apply to save your changes to the Switch's run-time memory. The Switch loses these changes if it is turned off or loses power, so use the Save link on the top navigation panel to save your changes to the non-volatile memory when you are done configuring.
Clear	Click Clear to clear the fields to the factory defaults.
Cancel	Click Cancel to not save the configuration you make and return to the last screen.

CHAPTER 27

Time Range

27.1 Time Range Overview

You can set up one-time and recurring schedules for time-oriented features, such as PoE and classifier. The UAG supports one-time and recurring schedules. One-time schedules are effective only once, while recurring schedules usually repeat. Both types of schedules are based on the current date and time in the Switch.

The time range can be configured in two ways – Absolute and Periodic. Absolute is a fixed time range with a start and end time. Periodic is recurrence of a time range and does not have an end time.

27.1.1 What You Can Do

Use the **Time Range** screen ([Section 27.2 on page 165](#)) to view or define a schedule on the Switch.

27.2 Configure a Time Range

Click **SYSTEM > Time Range** in the navigation panel to display the screen as shown.

Figure 121 SYSTEM > Time Range

<input type="checkbox"/>	Index	Name	Type	Range
<input type="checkbox"/>	1	schedule_4-14	Absolute	start 2022/04/14 06:05 end 2022/05/24 00:00
<input type="checkbox"/>	2	schedule_Repeat	Periodic	Monday 00:00 to Friday 17:00

The following table describes the labels in this screen.

Table 75 SYSTEM > Time Range

LABEL	DESCRIPTION
	Select an entry's checkbox to select a specific entry. Otherwise, select the checkbox in the table heading row to select all entries.
Index	This field displays the index number of the rule.
Name	This field displays the descriptive name for this rule. This is for identification purpose only. You can enter up to 32 printable ASCII characters except [?], [], ['], ["] or [,].

Table 75 SYSTEM > Time Range (continued)

LABEL	DESCRIPTION
Type	This displays the schedule type of the time range rule. Absolute An one-time schedule. One-time schedules begin on a specific start date and time and end on a specific stop date and time. One-time schedules are useful for long holidays and vacation periods. Periodic A recurring schedule. Recurring schedules begin at a specific start time and end at a specific stop time on selected days of the week (Sunday, Monday, Tuesday, Wednesday, Thursday, Friday, and Saturday). Recurring schedules are useful for defining the workday and off-work hours.
Range	This field displays the time periods to which this schedule applies.
Add/Edit	Click Add/Edit to add a new schedule rule or edit a selected one.
Delete	Click Delete to remove the selected rules.

27.2.1 Add/Edit Time Range

This screen allows you to create a new time range or edit an existing one.

To access this screen, click the **Add/Edit** button or select an entry from the list and click the **Add/Edit** button.

Figure 122 SYSTEM > Time Range > Add/Edit

The following table describes the labels in this screen.

Table 76 SYSTEM > Time Range > Add/Edit

LABEL	DESCRIPTION
Name	Enter a descriptive name for this rule for identifying purposes. The string should not contain [?], [], ['], ["] or [,].
Type	Select Absolute to create a one-time schedule. One-time schedules begin on a specific start date and time and end on a specific stop date and time. One-time schedules are useful for long holidays and vacation periods. Alternatively, select Periodic to create a recurring schedule. Recurring schedules begin at a specific start time and end at a specific stop time on selected days of the week (Sunday, Monday, Tuesday, Wednesday, Thursday, Friday, and Saturday). Recurring schedules are useful for defining the workday and off-work hours.

Table 76 SYSTEM > Time Range > Add/Edit (continued)

LABEL	DESCRIPTION
Absolute	This section is available only when you set Type to Absolute .
Start	Specify the year, month, day, hour and minute when the schedule begins.
End	Specify the year, month, day, hour and minute when the schedule ends.
Periodic	<p>This section is available only when you set Type to Periodic.</p> <p>Select the first option if you want to define a recurring schedule for a consecutive time period. You then select the day of the week, hour and minute when the schedule begins and ends respectively.</p> <p>Select the second option if you want to define a recurring schedule for multiple non-consecutive time periods. You need to select each day of the week the recurring schedule is effective. You also need to specify the hour and minute when the schedule begins and ends each day. The schedule begins and ends in the same day.</p>
Apply	Click Apply to save your changes to the Switch's run-time memory. The Switch loses these changes if it is turned off or loses power, so use the Save link on the top navigation panel to save your changes to the non-volatile memory when you are done configuring.
Clear	Click Clear to clear the fields to the factory defaults.
Cancel	Click Cancel to not save the configuration you make and return to the last screen.

CHAPTER 28

PORT

The following chapters introduces the configurations of the links under the **PORT** navigation panel.

Quick links to chapters:

- [Auto PD Recovery](#) (for PoE models only)
- [Green Ethernet](#)
- [Link Aggregation](#)
- [Link Layer Discovery Protocol \(LLDP\)](#)
- [PoE Setup](#) (for PoE models only)
- [Port Setup](#)

CHAPTER 29

Auto PD Recovery

29.1 Auto PD Recovery (for PoE models only) Overview

Things can go wrong with any network devices. A PD (for example, IP camera) may slow down or freeze and need to be restarted if it is overworked or a bug causes a memory leak. When a connected PD ceases to respond, Automatic PD Recovery allows the Switch to restart the PD by turning it off and on without the need for on-site troubleshooting.

29.1.1 What You Can Do

Use the **Auto PD Recovery** screen ([Section 29.2 on page 169](#)) to enable and configure automatic PD recovery on the Switch.

29.2 Auto PD Recovery

This screen lets you turn on automatic PD recovery on the Switch and its Ethernet ports. You can configure whether the Switch uses LLDP or ping to check the current status of a connected PD.

The ping is sent through the Switch's default management IP address to the designated port. To ping the PD, the port must share the same VLAN as the Switch's management VLAN.

Figure 123 Auto PD Recovery Application



The PD may stop responding to the Switch's detection over ping or LLDP during firmware upgrade. Disable the Auto PD Recovery function to prevent damage to the PD caused by a power cutoff during firmware upgrade.

Note: The following screens are available for the PoE models only.

To open this screen, click **PORT > Auto PD Recovery**.

Figure 124 PORT > Auto PD Recovery

Port	Active	Mode	Neighbor Name	Neighbor IP	Polling Interval (sec)	Polling Count	Action	Resume Polling Interval (sec)	PD Reboot Count
*	<input type="checkbox"/>	LLDP			20	3	Reboot-Alarm	600	1
1	<input type="checkbox"/>	LLDP			20	3	Reboot-Alarm	600	1
2	<input type="checkbox"/>	LLDP	12A3_84		20	3	Reboot-Alarm	600	1
3	<input type="checkbox"/>	LLDP			20	3	Reboot-Alarm	600	1
4	<input type="checkbox"/>	LLDP			20	3	Reboot-Alarm	600	1
5	<input type="checkbox"/>	LLDP			20	3	Reboot-Alarm	600	1
6	<input type="checkbox"/>	LLDP			20	3	Reboot-Alarm	600	1
7	<input type="checkbox"/>	LLDP			20	3	Reboot-Alarm	600	1
8	<input type="checkbox"/>	LLDP			20	3	Reboot-Alarm	600	1

The following table describes the labels in this screen.

Table 77 PORT > Auto PD Recovery

LABEL	DESCRIPTION
Active	Select this option to enable Auto PD Recovery on the Switch.
Port	This field displays the index number of a port on the Switch.
*	Settings in this row apply to all ports. Use this row only if you want to make some settings the same for all ports. Use this row first to set the common settings and then make adjustments on a port-by-port basis. Changes in this row are copied to all the ports as soon as you make them.
Active	Select Active to enable Auto PD Recovery on the ports.
Mode	Select LLDP to have the Switch passively monitor current status of the connected PD by reading LLDP packets from the PD on the port. The Switch also sends out LLDP packets to the PD to update the Switch Neighbor table on the PD. Select Ping to have the Switch ping the IP address of the connected PD to test whether the PD is reachable or not. Select ONVIF to have the Switch passively monitor current status of the connected ONVIF-compatible PD by reading ONVIF packets from the PD on the port. Note: Make sure to enable the ONVIF feature on the Switch.
Neighbor Name	If Mode is set to LLDP , the system name of the connected PD displays automatically.
Neighbor IP	If Mode is set to Ping and the PD supports LLDP, the connected PD's IPv4 or IPv6 address to which the Switch sends ping requests will display automatically. If not, enter the IP address manually.
Test	Click Test to have the Switch test the connection by sending a ping request to the IP address.
Polling Interval (sec)	Specify the number of seconds the Switch waits for a response before sending another ping request. For example, the Switch will try to detect the PD status by performing ping requests every 20 seconds.

Table 77 PORT > Auto PD Recovery (continued)

LABEL	DESCRIPTION
Polling Count	<p>Specify how many times the Switch is to resend a ping request before considering the PD unreachable.</p> <p>For example, If there is no ping reply from the PD after the Polling Interval (sec) has elapsed, Polling Count starts from 1. After Polling Count reaches 3, the PD Health status LED will turn to red in the MONITOR > Neighbor screen. The Switch will then perform your choice in the Action field.</p>
Action	<p>Set the action to take when the connected PD has stopped responding.</p> <p>Select Reboot-Alarm to have the Switch turn OFF the power of the connected PD (the connecting port is detected as link-down) and turn it back ON again to restart the PD after sending an SNMP trap and generating a log message.</p> <p>When restarting, the PD entry disappears from the Switch's LLDP table and the PD Health status LED will turn to yellow in the MONITOR > Neighbor screen.</p> <p>Select Alarm to have the Switch send an SNMP trap and generate a log message.</p>
Resume Polling Interval (sec)	Specify the number of seconds the Switch waits before monitoring the PD status again after it restarts the PD on the port.
PD Reboot Count	<p>Specify how many times the Switch attempts to restart the PD on the port.</p> <p>The PD Reboot Count will reset</p> <ul style="list-style-type: none"> • as soon as a ping is successful, • or when any modification to the Auto PD Recovery screen is applied, • or after restarting the Switch.
Resume Power Interval (sec)	Specify the number of seconds the Switch waits before supplying power to the connected PD again after it restarts the PD on the port.
Apply	Click Apply to save your changes to the Switch's run-time memory. The Switch loses these changes if it is turned off or loses power, so use the Save link on the top navigation panel to save your changes to the non-volatile memory when you are done configuring.
Cancel	Click this to reset the values in this screen to their last-saved values.

29.2.1 Activate the Automatic PD Recovery

Follow the steps below to activate the automatic PD recovery.

- 1 In the **PORT > Auto PD Recovery** screen, activate the feature.

Figure 125 Auto PD Recovery (Ping Mode)

Auto PD Recovery

Active

Port	Active	Mode	Neighbor Name	Neighbor IP	Polling Interval (sec)	Polling Count	Action	Resume Polling Interval (sec)	PD Reboot Count
*	<input type="checkbox"/>	LLDP		<input type="text"/> Test	<input type="text"/>	<input type="text"/>	Reboot-Alarm	<input type="text"/>	<input type="text"/>
1	<input checked="" type="checkbox"/>	Ping		10.214.45.49 Test	20	3	Reboot-Alarm	600	1
2	<input type="checkbox"/>	LLDP	12A3_84	<input type="text"/> Test	20	3	Reboot-Alarm	600	1
3	<input checked="" type="checkbox"/>	Ping		10.214.45.55 Test	20	3	Reboot-Alarm	600	1
4	<input type="checkbox"/>	LLDP		<input type="text"/> Test	20	3	Reboot-Alarm	600	1
5	<input type="checkbox"/>	LLDP		<input type="text"/> Test	20	3	Reboot-Alarm	600	1
6	<input type="checkbox"/>	LLDP		<input type="text"/> Test	20	3	Reboot-Alarm	600	1
7	<input type="checkbox"/>	LLDP		<input type="text"/> Test	20	3	Reboot-Alarm	600	1

Apply Cancel

Figure 126 Auto PD Recovery (LLDP Mode)

Auto PD Recovery

Active

Port	Active	Mode	Neighbor Name	Neighbor IP	Polling Interval (sec)	Polling Count	Action	Resume Polling Interval (sec)	PD Reboot Count
*	<input type="checkbox"/>	LLDP		<input type="text"/> Test	<input type="text"/>	<input type="text"/>	Reboot-Alarm	<input type="text"/>	<input type="text"/>
1	<input type="checkbox"/>	LLDP		10.214.45.49 Test	20	3	Reboot-Alarm	600	1
2	<input checked="" type="checkbox"/>	LLDP	12A3_84	<input type="text"/> Test	20	3	Reboot-Alarm	600	1
3	<input type="checkbox"/>	LLDP		10.214.45.55 Test	20	3	Reboot-Alarm	600	1
4	<input checked="" type="checkbox"/>	LLDP	12A4	<input type="text"/> Test	20	3	Reboot-Alarm	600	1
5	<input type="checkbox"/>	LLDP		<input type="text"/> Test	20	3	Reboot-Alarm	600	1
6	<input type="checkbox"/>	LLDP		<input type="text"/> Test	20	3	Reboot-Alarm	600	1
7	<input type="checkbox"/>	LLDP		<input type="text"/> Test	20	3	Reboot-Alarm	600	1

Apply Cancel

- 2 Select the desired ports in the **Active** column.
- 3 Select the **Mode**.

When you select **Ping**, the connected PD's IPv4 or IPv6 address to which the Switch sends ping requests will display automatically if the PD supports LLDP. If not, enter the IP address of the PDs in the **Neighbor IP** field.

The default setting for **Polling Interval (sec)** (20 secs) and **Polling Count** (3 times) will cause the Switch to ping the PD status every 20 seconds. If there is no ping reply from the PD, **Polling Count** starts to count from 1. Once **Polling Count** reaches 3, the Switch will cause a **Reboot-Alarm** on the PD as selected in **Action**.

When you select **LLDP**, the Switch monitors the PD status by checking incoming LLDP packets every 30 seconds from the PD (default value of transmit interval for LLDP feature).

Likewise, the Switch sends out LLDP packets to the PD every 30 seconds to update the **MONITOR > Neighbor** screen.

Once the LLDP table's counter reaches the default 120 seconds, the Switch will cause a **Reboot-Alarm** on the PD as selected in **Action**.

- 4 After sending an SNMP trap and generating a log message, the connected PD will restart (the connecting port is detected as link-down).

When restarting, the PD entry disappears from the Switch's LLDP table and the **PD Health** status LED will turn to yellow in the **MONITOR > Neighbor** screen.

The Switch will restore power to the PD based on your value for **Resume Power Interval**.

After the PD is powered on, the Switch resumes detection of the PD status by performing ping requests or checking the LLDP table based on your value for **Resume Polling Interval**.

When the **PD Reboot Count** value is reached, the Switch will no longer perform the PD recovery process. The **PD Health** status LED will turn to red in the **MONITOR > Neighbor** screen.

- 5 Click **Apply** to save your changes back to the run-time memory.
- 6 Click the **Save** link in the upper right corner of the Web Configurator to save your configuration permanently.

Note: In the event of a PD performing firmware upgrade, the PD may stop responding to ping or fail to provide LLDP packets for an extended period of time. When the Switch resets power to the PD before firmware upgrade is finished, it may permanently damage the PD or require a hard reset to recover it. **It is strongly advised to disable the Switch's Auto PD Recovery function before upgrading the PD's firmware. This will prevent damage caused by a power cutoff.**

CHAPTER 30

Green Ethernet

This chapter shows you how to configure the Switch to reduce the power consumed by switch ports.

30.1 Green Ethernet Overview

Green Ethernet reduces switch port power consumption in the following ways.

IEEE 802.3az Energy Efficient Ethernet (EEE)

If EEE is enabled, both sides of a link support EEE and there is no traffic, the port enters Low Power Idle (LPI) mode. LPI mode turns off some functions of the physical layer (becomes quiet) to save power. Periodically the port transmits a REFRESH signal to allow the link partner to keep the link alive. When there is traffic to be sent, a WAKE signal is sent to the link partner to return the link to active mode.

Auto Power Down

Auto Power Down turns off almost all functions of the port's physical layer functions when the link is down, so the port only uses power to check for a link up pulse from the link partner. After the link up pulse is detected, the port wakes up from **Auto Power Down** and operates normally.

Short Reach

Traditional Ethernet transmits all data with enough power to reach the maximum cable length. Shorter cables lose less power, so **Short Reach** saves power by adjusting the transmit power of each port according to the length of cable attached to that port.

30.2 Configure Green Ethernet

Click **PORT > Green Ethernet** in the navigation panel to display the screen as shown.

Note: EEE, Auto Power Down and Short Reach are NOT supported on an uplink port.

Figure 127 PORT > Green Ethernet

Port	EEE	Auto Power Down	Short Reach
*	<input type="checkbox"/>	<input type="checkbox"/>	<input type="checkbox"/>
1	<input type="checkbox"/>	<input type="checkbox"/>	<input type="checkbox"/>
2	<input type="checkbox"/>	<input type="checkbox"/>	<input type="checkbox"/>
3	<input type="checkbox"/>	<input type="checkbox"/>	<input type="checkbox"/>
4	<input type="checkbox"/>	<input type="checkbox"/>	<input type="checkbox"/>
5	<input type="checkbox"/>	<input type="checkbox"/>	<input type="checkbox"/>
6	<input type="checkbox"/>	<input type="checkbox"/>	<input type="checkbox"/>
7	<input type="checkbox"/>	<input type="checkbox"/>	<input type="checkbox"/>
8	<input type="checkbox"/>	<input type="checkbox"/>	<input type="checkbox"/>
9	<input type="checkbox"/>	<input type="checkbox"/>	<input type="checkbox"/>
10	<input type="checkbox"/>	<input type="checkbox"/>	<input type="checkbox"/>
11	<input type="checkbox"/>	<input type="checkbox"/>	<input type="checkbox"/>
12	<input type="checkbox"/>	<input type="checkbox"/>	<input type="checkbox"/>
13	<input type="checkbox"/>	<input type="checkbox"/>	<input type="checkbox"/>
14	<input type="checkbox"/>	<input type="checkbox"/>	<input type="checkbox"/>
15	<input type="checkbox"/>	<input type="checkbox"/>	<input type="checkbox"/>
16	<input type="checkbox"/>	<input type="checkbox"/>	<input type="checkbox"/>
17	<input type="checkbox"/>	<input type="checkbox"/>	<input type="checkbox"/>
18	<input type="checkbox"/>	<input type="checkbox"/>	<input type="checkbox"/>
19	<input type="checkbox"/>	<input type="checkbox"/>	<input type="checkbox"/>

The following table describes the labels in this screen.

Table 78 PORT > Green Ethernet

LABEL	DESCRIPTION
EEE	Enable the switch button to activate Energy Efficient Ethernet globally.
Auto Power Down	Enable the switch button to activate Auto Power Down globally.
Short Reach	Enable the switch button to activate Short Reach globally.
Port	This field displays the port number.
*	Use this row to make the setting the same for all ports. Use this row first and then make adjustments to each port if necessary. Changes in this row are copied to all the ports as soon as you make them.
EEE	Select this to activate Energy Efficient Ethernet on this port.
Auto Power Down	Select this to activate Auto Power Down on this port.
Short Reach	Select this to activate Short Reach on this port.
Apply	Click Apply to save your changes to the Switch's run-time memory. The Switch loses these changes if it is turned off or loses power, so use the Save link on the top navigation panel to save your changes to the non-volatile memory when you are done configuring.
Cancel	Click Cancel to begin configuring this screen afresh.

CHAPTER 31

Link Aggregation

31.1 Link Aggregation Overview

This chapter shows you how to logically aggregate physical links to form one logical, higher-bandwidth link.

Link aggregation (trunking) is the grouping of physical ports into one logical higher-capacity link. You may want to trunk ports if for example, it is cheaper to use multiple lower-speed links than to under-utilize a high-speed, but more costly, single-port link. However, the more ports you aggregate then the fewer available ports you have. A trunk group is one logical link containing multiple ports.

The beginning port of each trunk group must be physically connected to form a trunk group.

31.1.1 What You Can Do

- Use the **Link Aggregation Status** screen ([Section 31.2 on page 177](#)) to view ports you have configured to be in the trunk group, ports that are currently transmitting data as one logical link in the trunk group and so on.
- Use the **Link Aggregation Setting** screen ([Section 31.3 on page 179](#)) to configure static link aggregation.
- Use the **Link Aggregation Control Protocol** screen ([Section 31.4 on page 180](#)) to enable Link Aggregation Control Protocol (LACP).

31.1.2 What You Need to Know

The Switch supports both static and dynamic link aggregation.

Note: In a properly planned network, it is recommended to implement static link aggregation only. This ensures increased network stability and control over the trunk groups on your Switch.

See [Section 31.5.1 on page 182](#) for a static port trunking example.

Dynamic Link Aggregation

The Switch adheres to the IEEE 802.3ad standard for static and dynamic (LACP) port trunking.

The IEEE 802.3ad standard describes the Link Aggregation Control Protocol (LACP) for dynamically creating and managing trunk groups.

When you enable LACP link aggregation on a port, the port can automatically negotiate with the ports at the remote end of a link to establish trunk groups. LACP also allows port redundancy, that is, if an

operational port fails, then one of the “standby” ports become operational without user intervention. Please note that:

- You must connect all ports point-to-point to the same Ethernet switch and configure the ports for LACP trunking.
- LACP only works on full-duplex links.
- All ports in the same trunk group must have the same media type, speed, duplex mode and flow control settings.

Configure trunk groups or LACP before you connect the Ethernet switch to avoid causing network topology loops.

Link Aggregation ID

LACP aggregation ID consists of the following information¹:

Table 79 Link Aggregation ID: Local Switch

SYSTEM PRIORITY	MAC ADDRESS	KEY	PORT PRIORITY	PORT NUMBER
0000	00-00-00-00-00-00	0000	00	0000

Table 80 Link Aggregation ID: Peer Switch

SYSTEM PRIORITY	MAC ADDRESS	KEY	PORT PRIORITY	PORT NUMBER
0000	00-00-00-00-00-00	0000	00	0000

Algorithm Types Limitation

The maximum number of link aggregation algorithm types (**Criteria**) that can link up at the same time depends on your Switch model. See [Table 82 on page 178](#) for the list of **Criteria** that your Switch currently supports.

The following table shows the maximum number of link aggregation algorithm types that can link up at the same time.

Table 81 Link Aggregation Algorithm Types Limitation

MODEL	LINK AGGREGATION ALGORITHM TYPES (MAXIMUM)
GS1350 Series	2

For example, if your Switch has two link aggregation algorithm types that are currently online. The third link aggregation algorithm type can only go online when one of the online link aggregation algorithm type goes offline.

31.2 Link Aggregation Status

Click **PORT > Link Aggregation** in the navigation panel to display the screen as shown. See [Section 31.1 on page 176](#) for more information.

1. Port Priority and Port Number are 0 as it is the aggregator ID for the trunk group, not the individual port.

Figure 128 PORT > Link Aggregation

Link Aggregation Status		Link Aggregation Setting		Link Aggregation Control Protocol	
Group ID	Enabled Ports	Synchronized Ports	Aggregator ID	Criteria	Status
T1	-	-	-	src-dst-mac	-
T2	-	-	-	src-dst-mac	-
T3	-	-	-	src-dst-mac	-
T4	-	-	-	src-dst-mac	-
T5	-	-	-	src-dst-mac	-
T6	-	-	-	src-dst-mac	-
T7	-	-	-	src-dst-mac	-

The following table describes the labels in this screen.

Table 82 PORT > Link Aggregation

LABEL	DESCRIPTION
Group ID	This field displays the group ID to identify a trunk group, that is, one logical link containing multiple ports.
Enabled Ports	These are the ports you have configured in the Link Aggregation Setting screen to be in the trunk group. The port numbers displays only when this trunk group is activated and there is a port belonging to this group.
Synchronized Ports	These are the ports that are currently transmitting data as one logical link in this trunk group.
Aggregator ID	Link Aggregator ID consists of the following: system priority, MAC address, key, port priority and port number. The ID displays only when there is a port belonging to this trunk group and LACP is also enabled for this group.
Criteria	This shows the outgoing traffic distribution algorithm types used in this trunk group. Sending of packets are from the same source and/or to the same destination over the same link within the trunk. src-mac means the Switch distributes traffic based on the packet's source MAC address. dst-mac means the Switch distributes traffic based on the packet's destination MAC address. src-dst-mac means the Switch distributes traffic based on a combination of the packet's source and destination MAC addresses. src-ip means the Switch distributes traffic based on the packet's source IP address. dst-ip means the Switch distributes traffic based on the packet's destination IP address. src-dst-ip means the Switch distributes traffic based on a combination of the packet's source and destination IP addresses. Note: To find the number of link aggregation algorithm types that can link up at the same time, see Algorithm Types Limitation on page 177 .
Status	This field displays how these ports were added to the trunk group. It displays: <ul style="list-style-type: none"> Static – if the ports are configured as static members of a trunk group. LACP – if the ports are configured to join a trunk group through LACP.

31.3 Link Aggregation Setting

Click **PORT > Link Aggregation > Link Aggregation Setting** to display the screen shown next. See [Section 31.1 on page 176](#) for more information on link aggregation.

Figure 129 PORT > Link Aggregation > Link Aggregation Setting

Group ID	Active	Criteria
T1	<input checked="" type="checkbox"/>	src-dst-mac ▼
T2	<input type="checkbox"/>	src-dst-mac ▼
T3	<input type="checkbox"/>	src-dst-mac ▼
T4	<input type="checkbox"/>	src-dst-mac ▼
T5	<input type="checkbox"/>	src-dst-mac ▼
T6	<input type="checkbox"/>	src-dst-mac ▼
T7	<input type="checkbox"/>	src-dst-mac ▼

Port	Group
1	T1 ▼
2	None ▼
3	None ▼
4	None ▼
5	None ▼
6	None ▼
7	None ▼

The following table describes the labels in this screen.

Table 83 PORT > Link Aggregation > Link Aggregation Setting

LABEL	DESCRIPTION
	This is the only screen you need to configure to enable static link aggregation.
Group ID	The field identifies the link aggregation group, that is, one logical link containing multiple ports.
Active	Select this to activate a trunk group.

Table 83 PORT > Link Aggregation > Link Aggregation Setting (continued)

LABEL	DESCRIPTION
Criteria	<p>Select the outgoing traffic distribution type. Packets from the same source and/or to the same destination are sent over the same link within the trunk. By default, the Switch uses the src-dst-mac distribution type. If the Switch is behind a router, the packet's destination or source MAC address will be changed. In this case, set the Switch to distribute traffic based on its IP address to make sure port trunking can work properly.</p> <p>Select src-mac to distribute traffic based on the packet's source MAC address.</p> <p>Select dst-mac to distribute traffic based on the packet's destination MAC address.</p> <p>Select src-dst-mac to distribute traffic based on a combination of the packet's source and destination MAC addresses.</p> <p>Select src-ip to distribute traffic based on the packet's source IP address.</p> <p>Select dst-ip to distribute traffic based on the packet's destination IP address.</p> <p>Select src-dst-ip to distribute traffic based on a combination of the packet's source and destination IP addresses.</p>
Port	This field displays the port number.
Group	<p>Select the trunk group to which a port belongs.</p> <p>Note: When you enable the port security feature on the Switch and configure port security settings for a port, you cannot include the port in an active trunk group.</p>
Apply	Click Apply to save your changes to the Switch's run-time memory. The Switch loses these changes if it is turned off or loses power, so use the Save link on the top navigation panel to save your changes to the non-volatile memory when you are done configuring.
Cancel	Click Cancel to begin configuring this screen afresh.

31.4 Link Aggregation Control Protocol

Click **PORT > Link Aggregation > Link Aggregation Control Protocol** to display the screen shown next. See [Dynamic Link Aggregation on page 176](#) for more information on dynamic link aggregation.

Note: Do NOT configure this screen unless you want to enable dynamic link aggregation.

Figure 130 PORT > Link Aggregation > Link Aggregation Control Protocol

Status Link Aggregation Setting **Link Aggregation Control Protocol**

Active ON
 System Priority

Group ID	LACP Active
T1	<input type="checkbox"/>
T2	<input type="checkbox"/>
T3	<input type="checkbox"/>
T4	<input type="checkbox"/>
T5	<input type="checkbox"/>
T6	<input type="checkbox"/>
T7	<input type="checkbox"/>

Port	LACP Timeout
*	30 seconds
1	30 seconds
2	30 seconds
3	30 seconds
4	30 seconds
5	30 seconds
6	30 seconds
7	30 seconds

The following table describes the labels in this screen.

Table 84 PORT > Link Aggregation > Link Aggregation Control Protocol

LABEL	DESCRIPTION
Active	Enable the switch button to enable Link Aggregation Control Protocol (LACP).
System Priority	LACP system priority is a number between 1 and 65535. The switch with the lowest system priority (and lowest port number if system priority is the same) becomes the LACP "server". The LACP "server" controls the operation of LACP setup. Enter a number to set the priority of an active port using Link Aggregation Control Protocol (LACP). The smaller the number, the higher the priority level.
Use this section to enable LACP on trunks.	
Group ID	The field identifies the link aggregation group, that is, one logical link containing multiple ports.
LACP Active	Select this option to enable LACP for a trunk.
Use this section to configure LACP timeout on ports.	
Port	This field displays the port number.

Table 84 PORT > Link Aggregation > Link Aggregation Control Protocol (continued)

LABEL	DESCRIPTION
*	Settings in this row apply to all ports. Use this row only if you want to make some settings the same for all ports. Use this row first to set the common settings and then make adjustments on a port-by-port basis. Note: Changes in this row are copied to all the ports as soon as you make them.
LACP Timeout	Timeout is the time interval between the individual port exchanges of LACP packets in order to check that the peer port in the trunk group is still up. If a port does not respond after three tries, then it is deemed to be "down" and is removed from the trunk. Set a short timeout (1 second) for busy trunked links to ensure that disabled ports are removed from the trunk group as soon as possible. Select either 1 second or 30 seconds.
Apply	Click Apply to save your changes to the Switch's run-time memory. The Switch loses these changes if it is turned off or loses power, so use the Save link on the top navigation panel to save your changes to the non-volatile memory when you are done configuring.
Cancel	Click Cancel to begin configuring this screen afresh.

31.5 Technical Reference

This section provides technical background information on the topics discussed in this chapter.

31.5.1 Static Trunking Example

This example shows you how to create a static port trunk group for ports 2 – 5.

- 1 **Make your physical connections** – make sure that the ports that you want to belong to the trunk group are connected to the same destination. The following figure shows ports 2 – 5 on switch **A** connected to switch **B**.

Figure 131 Trunking Example – Physical Connections



- 2 **Configure static trunking** – Click **PORT > Link Aggregation > Link Aggregation Setting**. In this screen activate trunk group **T1**, select the traffic distribution algorithm used by this group and select the ports that should belong to this group as shown in the figure below. Click **Apply** when you are done.

Figure 132 Trunking Example – Configuration Screen

The screenshot displays the 'Link Aggregation Setting' configuration screen. It features two main tables and two buttons at the bottom.

Link Aggregation Status

Group ID	Active	Criteria
T1	<input checked="" type="checkbox"/>	src-dst-mac ▾
T2	<input type="checkbox"/>	src-dst-mac ▾
T3	<input type="checkbox"/>	src-dst-mac ▾
T4	<input type="checkbox"/>	src-dst-mac ▾
T5	<input type="checkbox"/>	src-dst-mac ▾
T6	<input type="checkbox"/>	src-dst-mac ▾
T7	<input type="checkbox"/>	src-dst-mac ▾

Port Assignment Table

Port	Group
1	None ▾
2	T1 ▾
3	T1 ▾
4	T1 ▾
5	T1 ▾
6	None ▾
7	None ▾

At the bottom of the screen, there are two buttons: **Apply** and **Cancel**.

Your trunk group 1 (T1) configuration is now complete.

CHAPTER 32

Link Layer Discovery Protocol (LLDP)

32.1 LLDP Overview

The LLDP (Link Layer Discovery Protocol) is a layer 2 protocol. It allows a network device to advertise its identity and capabilities on the local network. It also allows the device to maintain and store information from adjacent devices which are directly connected to the network device. This helps an administrator discover network changes and perform necessary network reconfiguration and management. The device information is encapsulated in the LLDPDUs (LLDP data units) in the form of TLV (Type, Length, Value). Device information carried in the received LLDPDUs is stored in the standard MIB.

The Switch supports these basic management TLVs.

- End of LLDPDU (mandatory)
- Chassis ID (mandatory)
- Port ID (mandatory)
- Time to Live (mandatory)
- Port Description (optional)
- System Name (optional)
- System Description (optional)
- System Capabilities (optional)
- Management Address (optional)

The Switch also supports the IEEE 802.1 and IEEE 802.3 organizationally-specific TLVs.

IEEE 802.1 specific TLVs:

- Port VLAN ID TLV (optional)
- Port and Protocol VLAN ID TLV (optional)

IEEE 802.3 specific TLVs:

- MAC/PHY Configuration/Status TLV (optional)
- Power via MDI TLV (optional, For PoE models only)
- Link Aggregation TLV (optional)
- Maximum Frame Size TLV (optional)

The optional TLVs are inserted between the Time To Live TLV and the End of LLDPDU TLV.

The next figure demonstrates that the network devices Switches and Routers (S and R) transmit and receive device information through LLDPDU and the network manager can query the information using Simple Network Management Protocol (SNMP).

Figure 133 LLDP Overview

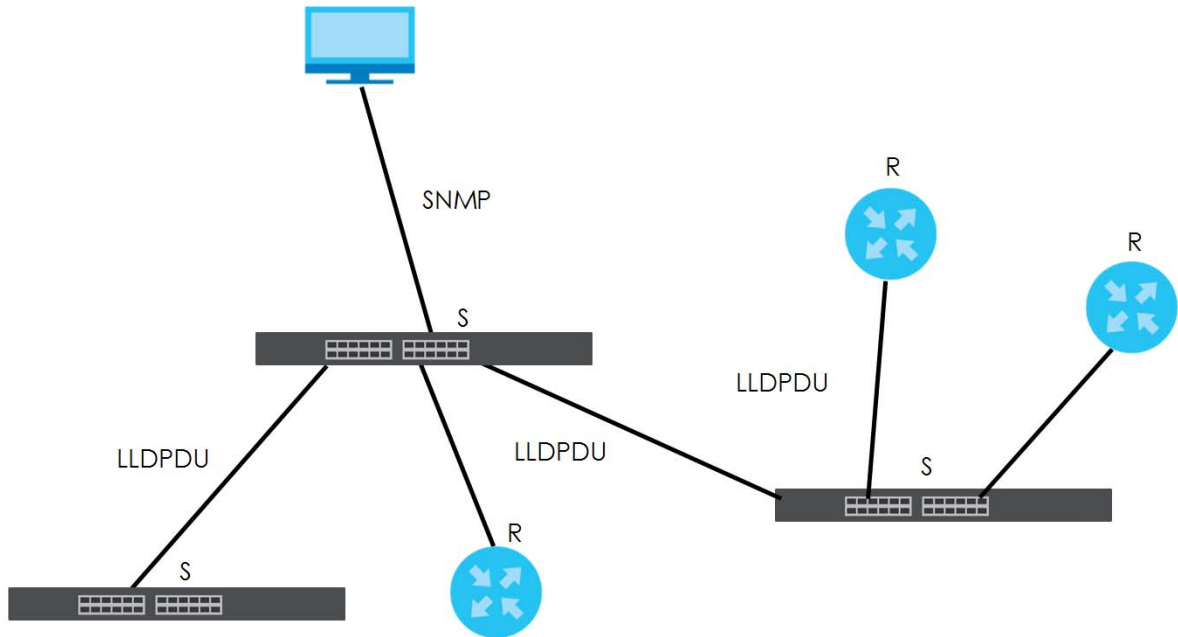

32.2 LLDP-MED Overview

LLDP-MED (Link Layer Discovery Protocol for Media Endpoint Devices) is an extension to the standard LLDP developed by the Telecommunications Industry Association (TIA) TR-41.4 subcommittee which defines the enhanced discovery capabilities, such as VoIP applications, to enable network administrators manage their network topology application more efficiently. Unlike the traditional LLDP, which has some limitations when handling multiple application devices, the LLDP-MED offers display of accurate physical topology, interoperability of devices, and easy trouble shooting for mis-configured IP addresses. There are three classes of endpoint devices that the LLDP-MED supports:

Class I: IP Communications Controllers or other communication related servers

Class II: Voice Gateways, Conference Bridges or Media Servers

Class III: IP-Phones, PC-based Softphones, End user Communication Appliances supporting IP Media

The following figure shows that with the LLDP-MED, network connectivity devices (NCD) like Switches and Routers will transmit LLDP TLV to endpoint device (ED) like IP Phone first (1), to get its device type and capabilities information, then it will receive that information in LLDP-MED TLV back from endpoint devices (2), after that the network connectivity devices will transmit LLDP-MED TLV (3) to provision the endpoint device to such that the endpoint device's network policy and location identification information is updated. Since LLDPDU updates status and configuration information periodically, network managers may check the result of provision through remote status. The remote status is updated by receiving LLDP-MED TLVs from endpoint devices.

Figure 134 LLDP-MED Overview

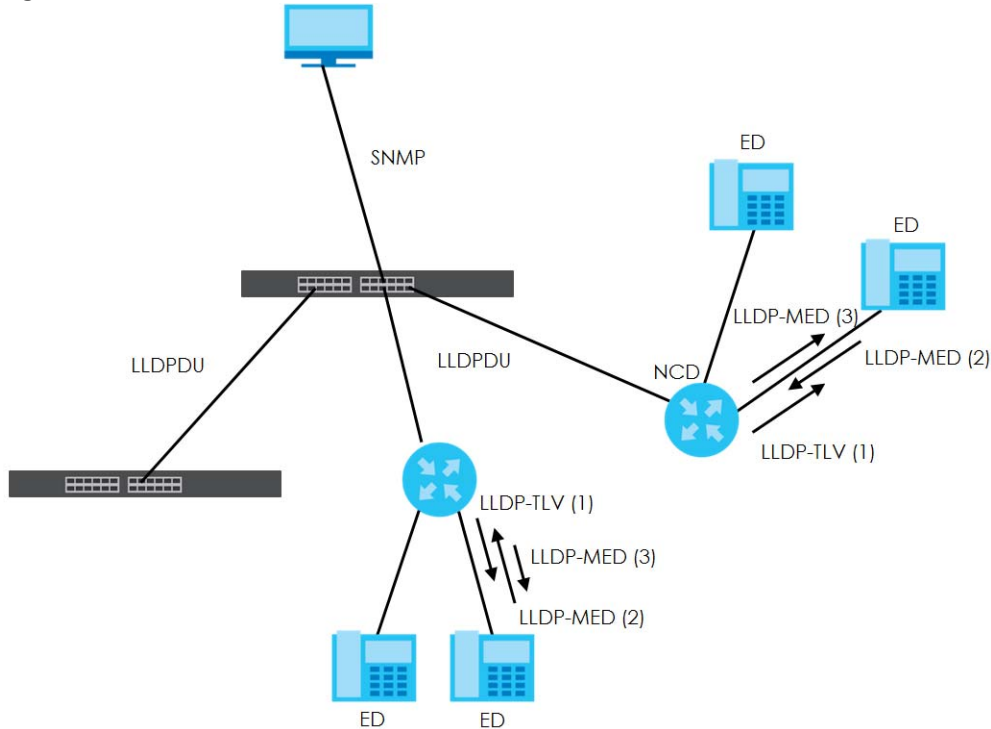

32.2.1 What You Can Do – LLDP

- Use the **LLDP Local Status** screen ([Section 32.3 on page 186](#)) to view the Switch's LLDP information.
- Use the **LLDP Remote Status** screen ([Section 32.4 on page 191](#)) to view LLDP information from the neighboring devices.
- Use the **LLDP Setup** screen ([Section 32.5 on page 196](#)) to configure LLDP on the Switch.
- Use the **Basic TLV Setting** screen ([Section 32.6 on page 198](#)) to configure basic TLV settings on each port.
- Use the **Org-specific TLV Setting** screen ([Section 32.7 on page 199](#)) to configure organization-specific TLV settings on each port.

32.2.2 What You Can Do – LLDP MED

- Use the **LLDP-MED Setup** screen ([Section 32.8 on page 200](#)) to configure LLDP-MED (Link Layer Discovery Protocol for Media Endpoint Devices) parameters.
- Use the **LLDP-MED Network Policy** screen ([Section 32.9 on page 201](#)) to configure LLDP-MED (Link Layer Discovery Protocol for Media Endpoint Devices) network policy parameters.
- Use the **LLDP-MED Location** screen ([Section 32.10 on page 202](#)) to configure LLDP-MED (Link Layer Discovery Protocol for Media Endpoint Devices) location parameters.

32.3 LLDP Local Status

This screen displays a summary of LLDP status on this Switch. Click **PORT > LLDP > LLDP > LLDP Local Status** to display the screen as shown next.

Figure 135 PORT > LLDP > LLDP > LLDP Local Status

LLDP Local Status		LLDP Remote Status	LLDP Setup	Basic TLV Setting	Org-specific TLV Setting
Basic TLV					
Chassis ID TLV			System Name TLV		
Chassis ID Subtype	mac-address		System Name	GS1350	
Chassis ID	d8:ec:e5:cf:66:4c		System Description TLV		
			System Description	V4.90(ABPL0)b2 09/27/2023	
System Capabilities TLV			Management Address TLV		
System Capabilities Supported	Bridge		Management Address Subtype	ipv4 / all-802	
System Capabilities Enabled	Bridge		Interface Number Subtype	unknown	
			Interface Number	0	
			Object Identifier	0	
LLDP Port Information					
Local Port	Port ID Subtype	Port ID	Port Description		
1	local-assigned	1			
2	local-assigned	2			
3	local-assigned	3			
4	local-assigned	4			
5	local-assigned	5			
6	local-assigned	6			
7	local-assigned	7			
8	local-assigned	8			
9	local-assigned	9			
10	local-assigned	10			
		11			

The following table describes the labels in this screen.

Table 85 PORT > LLDP > LLDP > LLDP Local Status

LABEL	DESCRIPTION
Basic TLV	
Chassis ID TLV	This displays the chassis ID of the local Switch, that is the Switch you are configuring. The chassis ID is identified by the chassis ID subtype. <ul style="list-style-type: none"> Chassis ID Subtype – This displays how the chassis of the Switch is identified. Chassis ID – This displays the chassis ID of the local Switch.
System Name TLV	System Name – This shows the host name of the Switch.
System Description TLV	System Description – This shows the firmware version of the Switch.
System Capabilities TLV	This shows the System Capabilities enabled and supported on the local Switch. <ul style="list-style-type: none"> System Capabilities Supported – Bridge System Capabilities Enabled – Bridge
Management Address TLV	The Management Address TLV identifies an address associated with the local LLDP agent that may be used to reach higher layer entities to assist discovery by network management. The TLV may also include the system interface number and an object identifier (OID) that are associated with this management address. <p>This field displays the Management Address settings on the specified ports.</p> <ul style="list-style-type: none"> Management Address Subtype – ipv4 or all-802 Interface Number Subtype – unknown Interface Number – 0 (not supported) Object Identifier – 0 (not supported)

Table 85 PORT > LLDP > LLDP > LLDP Local Status (continued)

LABEL	DESCRIPTION
LLDP Port Information This displays the local port information.	
Local Port	This displays the number of the Switch port which receives the LLDPDU from the remote device. Click a port number to view the detailed LLDP status on this port in the LLDP Local Port Status Details screen.
Port ID Subtype	This indicates how the port ID field is identified.
Port ID	This is an alpha-numeric string that contains the specific identifier for the port from which this LLDPDU was transmitted.
Port Description	This shows the port description that the Switch will advertise from this port.

32.3.1 LLDP Local Port Status Details

This screen displays detailed LLDP status for each port on this Switch. Click **PORT > LLDP > LLDP > LLDP Local Status** and then, click a port number, for example 1 in the local port column to display the screen as shown next.

Figure 136 PORT > LLDP > LLDP > LLDP Local Status > LLDP Local Port Status Details

The screenshot displays the 'LLDP Local Status' configuration page for 'Local Port: 1'. It is divided into several sections:

- Basic TLV:**
 - Port ID TLV:** Port ID Subtype: local-assigned, Port ID: 1.
 - Port Description TLV:** Port Description.
- Dot1 TLV:**
 - Port VLAN ID TLV:** Port VLAN ID: 1.
- Dot3 TLV:**
 - MAC PHY Configuration & Status TLV:** AN Supported: Yes, AN Enabled: Yes, AN Advertised Capability: Other 100baseTXFD 1000baseTFD, Oper MAU Type: 0.
 - Link Aggregation TLV:** Aggregation Capability: Yes, Aggregation Status: No, Aggregated Port ID: 0.
 - Max Frame Size TLV:** Max Frame Size: 1518.
- MED TLV:**
 - Capabilities TLV:** Network Policy: Yes, Location: Yes, Extend Power via MDI PSE: No, Extend Power via MDI PD: No, Inventory Management: No.
 - Network Policy TLV:** Voice, Voice-Signaling, Guest-Voice, Guest-Voice-Signaling, Softphone-Voice, Video-Conferencing, Streaming-Video, Video-Signaling.
- Device Type TLV:**
 - Device Type:** Network Connectivity.
 - Location Identification TLV:** Coordinate-base LCI, Civic LCI, ELIN.

The following table describes the labels in this screen.

Table 86 PORT > LLDP > LLDP > LLDP Local Status > LLDP Local Port Status Details

LABEL	DESCRIPTION
Local Port	This displays the number of the Switch's port.
Basic TLV	
These are the Basic TLV flags	
Port ID TLV	The port ID TLV identifies the specific port that transmitted the LLDP frame. <ul style="list-style-type: none"> • Port ID Subtype – This shows how the port is identified. • Port ID – This is the ID of the port.
Port Description TLV	Port Description – This displays the local port description.
Dot1 TLV	
Port VLAN ID TLV	Port VLAN ID – This displays the VLAN ID sent by the IEEE 802.1 Port VLAN ID TLV.

Table 86 PORT > LLDP > LLDP > LLDP Local Status > LLDP Local Port Status Details (continued)

LABEL	DESCRIPTION
Dot3 TLV	
MAC PHY Configuration & Status TLV	<p>The MAC/PHY Configuration/Status TLV advertises the bit-rate and duplex capability of the sending 802.3 node. It also advertises the current duplex and bit-rating of the sending node. Lastly, it advertises whether these settings were the result of auto-negotiation during link initiation or manual override.</p> <ul style="list-style-type: none"> • AN Supported – Displays if the port supports or does not support auto-negotiation. • AN Enabled – The current auto-negotiation status of the port. • AN Advertised Capability – The auto-negotiation capabilities of the port. • Oper MAU Type – The current Medium Attachment Unit (MAU) type of the port.
Link Aggregation TLV	<p>The Link Aggregation TLV indicates whether the link is capable of being aggregated, whether the link is currently in an aggregation, and if in an aggregation, the port identification of the aggregation.</p> <ul style="list-style-type: none"> • Aggregation Capability – The current aggregation capability of the port. • Aggregation Status – The current aggregation status of the port. • Aggregation Port ID – The aggregation ID of the current port.
Max Frame Size TLV	This displays the maximum supported frame size in octets.
<p>MED TLV</p> <p>LLDP Media Endpoint Discovery (MED) is an extension of LLDP that provides additional capabilities to support media endpoint devices. MED enables advertisement and discovery of network policies, device location discovery to allow creation of location databases, and information for troubleshooting.</p>	
Capabilities TLV	<p>This field displays which LLDP-MED TLV are capable to transmit on the Switch.</p> <ul style="list-style-type: none"> • Network Policy • Location • Extend Power via MDI PSE • Extend Power via MDI PD • Inventory Management
Network Policy TLV	<p>This displays a network policy for the specified application.</p> <ul style="list-style-type: none"> • Voice • Voice-Signaling • Guest-Voice • Guest-Voice-Signaling • Softphone-Voice • Video-Conferencing • Streaming-Video • Video-Signaling
Device Type TLV	<p>Device Type – This is the LLDP-MED device class.</p> <p>The Zyxel Switch device type is:</p> <ul style="list-style-type: none"> • Network Connectivity
Location Identification TLV	<p>This shows the location information of a caller by its ELIN (Emergency Location Identifier Number) or the IETF Geopriv Civic Address based Location Configuration Information (Civic Address LCI).</p> <ul style="list-style-type: none"> • Coordinate-based LCI – Latitude, longitude and altitude coordinates of the location Configuration Information (LCI) • Civic LCI – IETF Geopriv Civic Address based Location Configuration Information • ELIN – (Emergency Location Identifier Number)

32.4 LLDP Remote Status

This screen displays a summary of LLDP status for each LLDP connection to a neighboring Switch. Click **PORT > LLDP > LLDP > LLDP Remote Status** to display the screen as shown next.

Figure 137 PORT > LLDP > LLDP > LLDP Remote Status

LLDP Local Status	LLDP Remote Status	LLDP Setup	Basic TLV Setting	Org-specific TLV Setting		
Index	Local Port	Chassis ID	Port ID	Port Description	System Name	Management Address
1	18	c0:3f:c0:3f:c0:3f	c0:3f:c0:3f:c0:3f			
2	26	e4:e4:e4:e4:e4:e4	37		12A3_84	e4:e4:e4:e4:e4:e4

The following table describes the labels in this screen.

Table 87 PORT > LLDP > LLDP > LLDP Remote Status

LABEL	DESCRIPTION
Index	The index number shows the number of remote devices that are connected to the Switch. Click on an index number to view the detailed LLDP status for this remote device in the LLDP Remote Port Status Details screen.
Local Port	This is the number of the Switch's port that received LLDPDU from the remote device.
Chassis ID	This displays the chassis ID of the remote device associated with the transmitting LLDP agent. The chassis ID is identified by the chassis ID subtype. For example, the MAC address of the remote device.
Port ID	This is an alpha-numeric string that contains the specific identifier for the port from which this LLDPDU was transmitted. The port ID is identified by the port ID subtype.
Port Description	This displays a description for the port from which this LLDPDU was transmitted.
System Name	This displays the system name of the remote device.
Management Address	This displays the management address of the remote device. It could be the MAC address or IP address.

32.4.1 LLDP Remote Port Status Details

This screen displays detailed LLDP status of the remote device connected to the Switch. Click **PORT > LLDP > LLDP > LLDP Remote Status** and then click an index number, for example 1, in the **Index** column in the **LLDP Remote Status** screen to display the screen as shown next.

Figure 138 PORT > LLDP > LLDP > LLDP Remote Status > LLDP Remote Port Status Details (Basic TLV)

LLDP Local Status	LLDP Remote Status	LLDP Setup	Basic TLV Setting	Org-specific TLV Setting
LLDP Remote Status > LLDP Remote Port Status Details				
Local Port: 2				
Basic TLV				
Chassis ID TLV		Port ID TLV		
Chassis ID Subtype	mac-address	Port ID Subtype	local-assigned	
Chassis ID		Port ID	11	
Time To Live TLV		Port Description TLV		
Time To Live	120	Port Description		
System Name TLV		System Description TLV		
System Name	22A4_121	System Description V4.30(AAGF.2)_20200930 09/30/2020		
System Capabilities TLV		Management Address TLV		
System Capabilities Supported	bridge	Management Address Subtype	ALL_802	
System Capabilities Enabled	bridge	Management Address		
		Interface Number Subtype	unknown	
		Interface Number	0	
		Object Identifier		

The following table describes the labels in Basic TLV part of the screen.

Table 88 PORT > LLDP > LLDP > LLDP Remote Status > LLDP Remote Port Status Details (Basic TLV)

LABEL	DESCRIPTION
Local Port	This displays the number of the Switch's port to which the remote device is connected.
Basic TLV	
Chassis ID TLV	<ul style="list-style-type: none"> • Chassis ID Subtype – This displays how the chassis of the remote device is identified. • Chassis ID – This displays the chassis ID of the remote device. The chassis ID is identified by the chassis ID subtype.
Port ID TLV	<ul style="list-style-type: none"> • Port ID Subtype – This displays how the port of the remote device is identified. • Port ID – This displays the port ID of the remote device. The port ID is identified by the port ID subtype.
Time To Live TLV	Time To Live – This displays the time-to-live (TTL) multiplier of LLDP frames. The device information on the neighboring devices ages out and is discarded when its corresponding TTL expires. The TTL value is to multiply the TTL multiplier by the LLDP frames transmitting interval.
Port Description TLV	Port Description – This displays the remote port description.
System Name TLV	System Name – This displays the system name of the remote device.
System Description TLV	System Description – This displays the system description of the remote device.
System Capabilities TLV	This displays whether the system capabilities are enabled and supported on the remote device. <ul style="list-style-type: none"> • System Capabilities Supported • System Capabilities Enabled
Management Address TLV	This displays the management address (IPv4 and IPv6) of the remote device. <ul style="list-style-type: none"> • Management Address Subtype • Management Address • Interface Number Subtype • Interface Number • Object Identifier

Figure 139 PORT > LLDP > LLDP > LLDP Remote Status > LLDP Remote Port Status Details (Dot1 and Dot3 TLV)

Dot1 TLV	
Port VLAN ID TLV	
Port VLAN ID	2040
Vlan Name TLV	
	VLAN ID
	VLAN Name
Protocol Identity TLV	
Protocol ID	
Port-Protocol VLAN ID TLV	
	Port-Protocol VLAN ID
	Port-Protocol VLAN ID Supported
	Port-Protocol VLAN ID Enabled
Dot3 TLV	
MAC PHY Configuration & Status TLV	
AN Supported	Yes
AN Enabled	Yes
AN Advertised Capability	10baseT 10baseTFD 100baseTX 100baseTXFD 1000baseTFD
Oper MAU type	30
Max Frame Size TLV	
	Max Frame Size
Link Aggregation TLV	
	Aggregation Capability
	Aggregation Status
	Aggregated Port ID
Power Via MDI TLV	
	Port Class
	MDI Supported
	MDI Enabled
	Pair Controllable
	PSE Power Pairs
	Power Class

The following table describes the labels in the Dot1 and Dot3 parts of the screen.

Table 89 PORT > LLDP > LLDP > LLDP Remote Status > LLDP Remote Port Status Details (Dot1 and Dot3 TLV)

LABEL	DESCRIPTION
Dot1 TLV	
Port VLAN ID TLV	Port VLAN ID – This displays the VLAN ID of this port on the remote device.
Vlan Name TLV	This shows the VLAN ID and name for remote device port. <ul style="list-style-type: none"> VLAN ID VLAN Name
Protocol Identity TLV	Protocol ID – The Protocol Identity TLV allows the Switch to advertise the particular protocols that are accessible through its port.
Port-Protocol VLAN ID TLV	This displays the IEEE 802.1 Port Protocol VLAN ID TLV, which indicates whether the VLAN ID and whether it is enabled and supported on the port of remote Switch which sent the LLDPDU. <ul style="list-style-type: none"> Port-Protocol VLAN ID Port-Protocol VLAN ID Supported Port-Protocol VLAN ID Enabled
Dot3 TLV	

Table 89 PORT > LLDP > LLDP > LLDP Remote Status > LLDP Remote Port Status Details (Dot1 and Dot3 TLV) (continued)

LABEL	DESCRIPTION
MAC PHY Configuration & Status TLV	<p>The MAC/PHY Configuration/Status TLV advertises the bit-rate and duplex capability of the sending 802.3 node. It also advertises the current duplex and bit-rating of the sending node. Lastly, it advertises whether these setting were the result of auto-negotiation during link initiation or manual override.</p> <ul style="list-style-type: none"> • AN Supported – Displays if the port supports or does not support auto-negotiation. • AN Enabled – The current auto-negotiation status of the port. • AN Advertised Capability – The auto-negotiation capabilities of the port. • Oper MAU Type – The current Medium Attachment Unit (MAU) type of the port.
Max Frame Size TLV	<p>Max Frame Size – This displays the maximum supported frame size in octets.</p>
Link Aggregation TLV	<p>The Link Aggregation TLV indicates whether the link is capable of being aggregated, whether the link is currently in an aggregation, and if in an aggregation, the port identification of the aggregation.</p> <ul style="list-style-type: none"> • Aggregation Capability – The current aggregation capability of the port. • Aggregation Status – The current aggregation status of the port. • Aggregated Port ID – The aggregation ID of the current port.
Power Via MDI TLV	<p>The Power Via MDI TLV allows network management to advertise and discover the MDI power support capabilities of the sending port on the remote device.</p> <ul style="list-style-type: none"> • Port Class • MDI Supported • MDI Enabled • Pair Controllable • PSE Power Pairs • Power Class

Figure 140 PORT > LLDP > LLDP > LLDP Remote Status > LLDP Remote Port Status Details (MED TLV)

MED TLV	
Capabilities TLV Network Policy Location Extend Power via MDI PSE Extend Power via MDI PD Inventory Management	Device Type TLV Device Type Location Identification TLV Coordinate-base LCI Civic LCI ELIN
Extended Power via MDI TLV Power Type Power Source Power Priority Power Value	Network Policy TLV Voice Voice-Signaling Guest-Voice Guest-Voice-Signaling Softphone-Voice Video-Conferencing Streaming-Video Video-Signaling
Inventory TLV Hardware Revision Software Revision Firmware Revision Model Name Manufacturer Serial Number Asset ID	

The following table describes the labels in the MED TLV part of the screen.

Table 90 PORT > LLDP > LLDP > LLDP Remote Status > LLDP Remote Port Status Details (MED TLV)

LABEL	DESCRIPTION
MED TLV	LLDP Media Endpoint Discovery (MED) is an extension of LLDP that provides additional capabilities to support media endpoint devices. MED enables advertisement and discovery of network policies, device location discovery to allow creation of location databases, and information for troubleshooting.
Capabilities TLV	This displays the MED capabilities the remote port supports. <ul style="list-style-type: none"> • Network Policy • Location • Extend Power via MDI PSE • Extend Power via MDI PD • Inventory Management
Device Type TLV	LLDP-MED endpoint device classes: <ul style="list-style-type: none"> • Endpoint Class I • Endpoint Class II • Endpoint Class III • Network Connectivity

Table 90 PORT > LLDP > LLDP > LLDP Remote Status > LLDP Remote Port Status Details (MED TLV)

LABEL	DESCRIPTION
Location Identification TLV	<p>This shows the location information of a caller by its:</p> <ul style="list-style-type: none"> • Coordinate-base LCI – Latitude and longitude coordinates of the Location Configuration Information (LCI) • Civic LCI – IETF Geopriv Civic Address based Location Configuration Information • ELIN – (Emergency Location Identifier Number)
Extended Power via MDI TLV	<p>Extended Power Via MDI Discovery enables detailed power information to be advertised by Media Endpoints, such as IP phones and Network Connectivity Devices such as the Switch.</p> <ul style="list-style-type: none"> • Power Type – Whether it is currently operating from primary power or is on backup power (backup power may indicate to the Endpoint Device that it should move to a power conservation mode). • Power Source – Whether or not the Endpoint is currently operating from an external power source. • Power Priority – The Endpoint Device's power priority (which the Network Connectivity Device may use to prioritize which devices will remain in service during power shortages). • Power Value – Power requirement, in fractions of Watts, in current configuration.
Network Policy TLV	<p>This displays a network policy for the specified application.</p> <ul style="list-style-type: none"> • Voice • Voice-Signaling • Guest-Voice • Guest-Voice-Signaling • Softphone-Voice • Video-Conferencing • Streaming-Video • Video-Signaling
Inventory TLV	<p>The majority of IP Phones lack support of management protocols such as SNMP, so LLDP-MED inventory TLVs are used to provide their inventory information to the Network Connectivity Devices such as the Switch. The Inventory TLV may contain the following information.</p> <ul style="list-style-type: none"> • Hardware Revision • Software Revision • Firmware Revision • Model Name • Manufacturer • Serial Number • Asset ID

32.5 LLDP Setup

Use this screen to configure global LLDP settings on the Switch. Click **PORT > LLDP > LLDP > LLDP Setup** to display the screen as shown next.

Figure 141 PORT > LLDP > LLDP > LLDP Setup

LLDP Local Status LLDP Remote Status **LLDP Setup** Basic TLV Setting

Active ON

Transmit Interval seconds

Transmit Hold times

Transmit Delay seconds

Reinitialize Delay seconds

Port	Admin Status	Notification
*	Tx-Rx ▾	<input type="checkbox"/>
1	Tx-Rx ▾	<input type="checkbox"/>
2	Tx-Rx ▾	<input type="checkbox"/>
3	Tx-Rx ▾	<input type="checkbox"/>
4	Tx-Rx ▾	<input type="checkbox"/>
5	Tx-Rx ▾	<input type="checkbox"/>
6	Tx-Rx ▾	<input type="checkbox"/>
7	Tx-Rx ▾	<input type="checkbox"/>

The following table describes the labels in this screen.

Table 91 PORT > LLDP > LLDP > LLDP Setup

LABEL	DESCRIPTION
Active	Select to enable LLDP on the Switch. It is enabled by default.
Transmit Interval	Enter how many seconds the Switch waits before sending LLDP packets.
Transmit Hold	Enter the time-to-live (TTL) multiplier of LLDP frames. The device information on the neighboring devices ages out and is discarded when its corresponding TTL expires. The TTL value is to multiply the TTL multiplier by the LLDP packets transmitting interval.
Transmit Delay	Enter the delay (in seconds) between successive LLDPDU transmissions initiated by value or status changes in the Switch MIB.
Reinitialize Delay	Enter the number of seconds for LLDP to wait before initializing on a port.
Apply	Click Apply to save your changes to the Switch's run-time memory. The Switch loses these changes if it is turned off or loses power, so use the Save link on the top navigation panel to save your changes to the non-volatile memory when you are done configuring.
Cancel	Click Cancel to begin configuring this screen afresh.
Port	This displays the Switch's port number. * means all ports.
*	Use this row to make the setting the same for all ports. Use this row first and then make adjustments to each port if necessary. Changes in this row are copied to all the ports as soon as you make them.

Table 91 PORT > LLDP > LLDP > LLDP Setup (continued)

LABEL	DESCRIPTION
Admin Status	Select whether LLDP transmission and/or reception is allowed on this port. <ul style="list-style-type: none"> • Disable – not allowed • Tx-Only – transmit only • Rx-Only – receive only • Tx-Rx – transmit and receive
Notification	Select whether LLDP notification is enabled on this port.
Apply	Click Apply to save your changes to the Switch's run-time memory. The Switch loses these changes if it is turned off or loses power, so use the Save link on the top navigation panel to save your changes to the non-volatile memory when you are done configuring.
Cancel	Click Cancel to begin configuring this screen afresh.

32.6 Basic TLV Setting

Use this screen to configure Basic TLV settings. Click **PORT > LLDP > LLDP > Basic TLV Setting** to display the screen as shown next.

Figure 142 PORT > LLDP > LLDP > Basic TLV Setting

Port	Management Address	Port Description	System Capabilities	System Description	System Name
*	<input type="checkbox"/>	<input type="checkbox"/>	<input type="checkbox"/>	<input type="checkbox"/>	<input type="checkbox"/>
1	<input checked="" type="checkbox"/>	<input checked="" type="checkbox"/>	<input checked="" type="checkbox"/>	<input checked="" type="checkbox"/>	<input checked="" type="checkbox"/>
2	<input checked="" type="checkbox"/>	<input checked="" type="checkbox"/>	<input checked="" type="checkbox"/>	<input checked="" type="checkbox"/>	<input checked="" type="checkbox"/>
3	<input checked="" type="checkbox"/>	<input checked="" type="checkbox"/>	<input checked="" type="checkbox"/>	<input checked="" type="checkbox"/>	<input checked="" type="checkbox"/>
4	<input checked="" type="checkbox"/>	<input checked="" type="checkbox"/>	<input checked="" type="checkbox"/>	<input checked="" type="checkbox"/>	<input checked="" type="checkbox"/>
5	<input checked="" type="checkbox"/>	<input checked="" type="checkbox"/>	<input checked="" type="checkbox"/>	<input checked="" type="checkbox"/>	<input checked="" type="checkbox"/>
6	<input checked="" type="checkbox"/>	<input checked="" type="checkbox"/>	<input checked="" type="checkbox"/>	<input checked="" type="checkbox"/>	<input checked="" type="checkbox"/>
7	<input checked="" type="checkbox"/>	<input checked="" type="checkbox"/>	<input checked="" type="checkbox"/>	<input checked="" type="checkbox"/>	<input checked="" type="checkbox"/>

The following table describes the labels in this screen.

Table 92 PORT > LLDP > LLDP > Basic TLV Setting

LABEL	DESCRIPTION
Port	This displays the Switch's port number.
*	Use this row to make the setting the same for all ports. Use this row first and then make adjustments to each port if necessary. Changes in this row are copied to all the ports as soon as you make them.
Management Address	Select the checkboxes to enable or disable the sending of Management Address TLVs on the ports.
Port Description	Select the checkboxes to enable or disable the sending of Port Description TLVs on the ports.

Table 92 PORT > LLDP > LLDP > Basic TLV Setting (continued)

LABEL	DESCRIPTION
System Capabilities	Select the checkboxes to enable or to disable the sending of System Capabilities TLVs on the ports.
System Description	Select the checkboxes to enable or to disable the sending of System Description TLVs on the ports.
System Name	Select the checkboxes to enable or to disable the sending of System Name TLVs on the ports.
Apply	Click Apply to save your changes to the Switch's run-time memory. The Switch loses these changes if it is turned off or loses power, so use the Save link on the top navigation panel to save your changes to the non-volatile memory when you are done configuring.
Cancel	Click Cancel to begin configuring this screen afresh.

32.7 Org-specific TLV Setting

Use this screen to configure organization-specific TLV settings. Click **PORT > LLDP > LLDP > Org-specific TLV Setting** to display the screen as shown next.

Figure 143 PORT > LLDP > LLDP > Org-specific TLV Setting

LLDP Local Status		LLDP Remote Status		LLDP Setup		Basic TLV Setting		Org-specific TLV Setting	
Port	Dot1 TLV	Port VLAN ID	Link Aggregation	Dot3 TLV	MAC/PHY	Max Frame Size			
*	<input type="checkbox"/>	<input type="checkbox"/>	<input type="checkbox"/>	<input type="checkbox"/>	<input type="checkbox"/>	<input type="checkbox"/>			
1	<input checked="" type="checkbox"/>	<input checked="" type="checkbox"/>	<input type="checkbox"/>	<input checked="" type="checkbox"/>	<input checked="" type="checkbox"/>	<input type="checkbox"/>			
2	<input checked="" type="checkbox"/>	<input checked="" type="checkbox"/>	<input type="checkbox"/>	<input checked="" type="checkbox"/>	<input checked="" type="checkbox"/>	<input type="checkbox"/>			
3	<input checked="" type="checkbox"/>	<input checked="" type="checkbox"/>	<input type="checkbox"/>	<input checked="" type="checkbox"/>	<input checked="" type="checkbox"/>	<input type="checkbox"/>			
4	<input checked="" type="checkbox"/>	<input checked="" type="checkbox"/>	<input type="checkbox"/>	<input checked="" type="checkbox"/>	<input checked="" type="checkbox"/>	<input type="checkbox"/>			
5	<input checked="" type="checkbox"/>	<input checked="" type="checkbox"/>	<input type="checkbox"/>	<input checked="" type="checkbox"/>	<input checked="" type="checkbox"/>	<input type="checkbox"/>			
6	<input checked="" type="checkbox"/>	<input checked="" type="checkbox"/>	<input type="checkbox"/>	<input checked="" type="checkbox"/>	<input checked="" type="checkbox"/>	<input type="checkbox"/>			
7	<input checked="" type="checkbox"/>	<input checked="" type="checkbox"/>	<input type="checkbox"/>	<input checked="" type="checkbox"/>	<input checked="" type="checkbox"/>	<input type="checkbox"/>			
8	<input checked="" type="checkbox"/>	<input checked="" type="checkbox"/>	<input type="checkbox"/>	<input checked="" type="checkbox"/>	<input checked="" type="checkbox"/>	<input type="checkbox"/>			
9	<input checked="" type="checkbox"/>	<input checked="" type="checkbox"/>	<input type="checkbox"/>	<input checked="" type="checkbox"/>	<input checked="" type="checkbox"/>	<input type="checkbox"/>			
10	<input checked="" type="checkbox"/>	<input checked="" type="checkbox"/>	<input type="checkbox"/>	<input checked="" type="checkbox"/>	<input checked="" type="checkbox"/>	<input type="checkbox"/>			
11	<input checked="" type="checkbox"/>	<input checked="" type="checkbox"/>	<input type="checkbox"/>	<input checked="" type="checkbox"/>	<input checked="" type="checkbox"/>	<input type="checkbox"/>			
12	<input checked="" type="checkbox"/>	<input checked="" type="checkbox"/>	<input type="checkbox"/>	<input checked="" type="checkbox"/>	<input checked="" type="checkbox"/>	<input type="checkbox"/>			
13	<input checked="" type="checkbox"/>	<input checked="" type="checkbox"/>	<input type="checkbox"/>	<input checked="" type="checkbox"/>	<input checked="" type="checkbox"/>	<input type="checkbox"/>			
14	<input checked="" type="checkbox"/>	<input checked="" type="checkbox"/>	<input type="checkbox"/>	<input checked="" type="checkbox"/>	<input checked="" type="checkbox"/>	<input type="checkbox"/>			
15	<input checked="" type="checkbox"/>	<input checked="" type="checkbox"/>	<input type="checkbox"/>	<input checked="" type="checkbox"/>	<input checked="" type="checkbox"/>	<input type="checkbox"/>			
16	<input checked="" type="checkbox"/>	<input checked="" type="checkbox"/>	<input type="checkbox"/>	<input checked="" type="checkbox"/>	<input checked="" type="checkbox"/>	<input type="checkbox"/>			
17	<input checked="" type="checkbox"/>	<input checked="" type="checkbox"/>	<input type="checkbox"/>	<input checked="" type="checkbox"/>	<input checked="" type="checkbox"/>	<input type="checkbox"/>			
18	<input checked="" type="checkbox"/>	<input checked="" type="checkbox"/>	<input type="checkbox"/>	<input checked="" type="checkbox"/>	<input checked="" type="checkbox"/>	<input type="checkbox"/>			

The following table describes the labels in this screen.

Table 93 PORT > LLDP > LLDP > Org-specific TLV Setting

LABEL	DESCRIPTION
Port	This displays the Switch's port number.
*	Use this row to make the setting the same for all ports. Use this row first and then make adjustments to each port if necessary. Changes in this row are copied to all the ports as soon as you make them.
Dot1 TLV	

Table 93 PORT > LLDP > LLDP > Org-specific TLV Setting (continued)

LABEL	DESCRIPTION
Port VLAN ID	Select the checkboxes to enable or disable the sending of IEEE 802.1 Port VLAN ID TLVs on the ports. All checkboxes in this column are enabled by default.
Dot3 TLV	
Link Aggregation	Select the checkboxes to enable or disable the sending of IEEE 802.3 Link Aggregation TLVs on the ports.
MAC/PHY	Select the checkboxes to enable or disable the sending of IEEE 802.3 MAC/PHY Configuration/Status TLVs on the ports. All checkboxes in this column are enabled by default.
Max Frame Size	Select the checkboxes to enable or disable the sending of IEEE 802.3 Max Frame Size TLVs on the ports.
Apply	Click Apply to save your changes to the Switch's run-time memory. The Switch loses these changes if it is turned off or loses power, so use the Save link on the top navigation panel to save your changes to the non-volatile memory when you are done configuring.
Cancel	Click Cancel to begin configuring this screen afresh.

32.8 LLDP-MED Setup

Click **PORT > LLDP > LLDP MED > LLDP-MED Setup** to display the screen as shown next.

Figure 144 PORT > LLDP > LLDP MED > LLDP-MED Setup

Port	Notification	MED TLV Setting	
	Topology Change	Location	Network Policy
*	<input type="checkbox"/>	<input type="checkbox"/>	<input type="checkbox"/>
1	<input type="checkbox"/>	<input type="checkbox"/>	<input type="checkbox"/>
2	<input type="checkbox"/>	<input type="checkbox"/>	<input type="checkbox"/>
3	<input type="checkbox"/>	<input type="checkbox"/>	<input type="checkbox"/>
4	<input type="checkbox"/>	<input type="checkbox"/>	<input type="checkbox"/>
5	<input type="checkbox"/>	<input type="checkbox"/>	<input type="checkbox"/>
6	<input type="checkbox"/>	<input type="checkbox"/>	<input type="checkbox"/>
7	<input type="checkbox"/>	<input type="checkbox"/>	<input type="checkbox"/>

The following table describes the labels in this screen.

Table 94 PORT > LLDP > LLDP MED > LLDP-MED Setup

LABEL	DESCRIPTION
Port	This displays the Switch's port number. Select * to configure all ports simultaneously.
*	Use this row to make the setting the same for all ports. Use this row first and then make adjustments to each port if necessary. Changes in this row are copied to all the ports as soon as you make them.
Notification	

Table 94 PORT > LLDP > LLDP MED > LLDP-MED Setup (continued)

LABEL	DESCRIPTION
Topology Change	Select to enable LLDP-MED topology change traps on this port.
MED TLV Setting	
Location	Select to enable transmitting LLDP-MED location TLV.
Network Policy	Select to enable transmitting LLDP-MED Network Policy TLV.
Apply	Click Apply to save the changes to the Switch's run-time memory. The Switch loses these changes if it is turned off or loses power, so use the Save link on the top navigation panel to save your changes to the non-volatile memory when you are done configuring.
Cancel	Click Cancel to begin configuring this screen afresh.

32.9 LLDP-MED Network Policy

Click **PORT > LLDP > LLDP MED > LLDP-MED Network Policy** to display the screen as shown next.

Figure 145 PORT > LLDP > LLDP MED > LLDP-MED Network Policy

Index	Port	Application Type	Tag	VLAN	DSCP	Priority
<input type="checkbox"/>	1	voice	tagged	1	10	0

The following table describes the labels in this screen.

Table 95 PORT > LLDP > LLDP MED > LLDP-MED Network Policy

LABEL	DESCRIPTION
Index	This field displays the of index number of the network policy. Click an index number to edit the rule.
Port	This field displays the port number of the network policy.
Application Type	This field displays the application type of the network policy.
Tag	This field displays the Tag Status of the network policy.
VLAN	This field displays the VLAN ID of the network policy.
DSCP	This field displays the DSCP value of the network policy.
Priority	This field displays the priority value of the network policy.
	Select an entry's checkbox to select a specific entry. Otherwise, select the checkbox in the table heading row to select all entries.
Add/Edit	Click Add/Edit to add a new schedule rule or edit a selected one.
Delete	Select the rules that you want to remove, then click Delete .

32.9.1 Add/Edit LLDP-MED Network Policy

To access this screen, click the **Add/Edit** button or select an entry from the list and click the **Add/Edit** button.

Figure 146 PORT > LLDP > LLDP MED > LLDP-MED Network Policy > Add/Edit

The screenshot shows a configuration form with the following fields and values:

- Port: [Empty text box]
- Application Type: [voice] (dropdown menu)
- Tag: [tagged] (dropdown menu)
- VLAN: [Empty text box]
- DSCP: [Empty text box]
- Priority: [0] (dropdown menu)

Buttons at the bottom: **Apply** (green), Clear, and Cancel.

The following table describes the labels in this screen.

Table 96 PORT > LLDP > LLDP MED > LLDP-MED Network Policy > Add/Edit

LABEL	DESCRIPTION
Port	Enter the port number to set up the LLDP-MED network policy. You can enter multiple ports separated by (no space) comma (",") or hyphen ("-") for a range. For example, enter "3-5" for ports 3, 4, and 5. Enter "3,5,7" for ports 3, 5, and 7.
Application Type	Select the type of application used in the network policy. <ul style="list-style-type: none"> • voice • voice-signaling • guest-voice • guest-voice-signaling • softphone-voice • video-conferencing • streaming-video • video-signaling
Tag	Select to tag or untag in the network policy. <ul style="list-style-type: none"> • tagged • untagged
VLAN	Enter the VLAN ID number. It should be from 1 to 4094. For priority tagged frames, enter "0".
DSCP	Enter the DSCP value of the network policy. The value is defined from 0 through 63 with the 0 representing use of the default DSCP value.
Priority	Enter the priority value for the network policy.
Apply	Click Apply to save your changes to the Switch's run-time memory. The Switch loses these changes if it is turned off or loses power, so use the Save link on the top navigation panel to save your changes to the non-volatile memory when you are done configuring.
Clear	Click Clear to clear the fields to the factory defaults.
Cancel	Click Cancel to not save the configuration you make and return to the last screen.

32.10 LLDP-MED Location

Click **PORT > LLDP > LLDP MED > LLDP-MED Location** to display the screen as shown next.

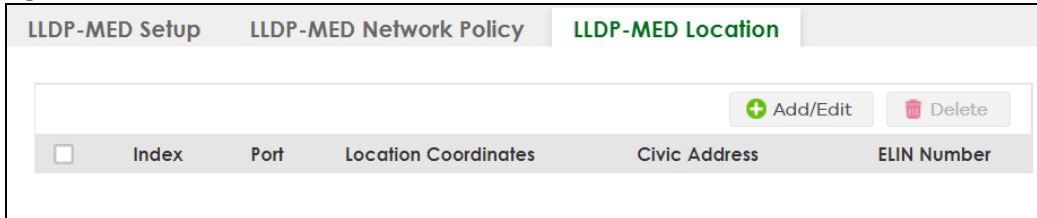
Figure 147 PORT > LLDP > LLDP MED > LLDP-MED Location

The following table describes the labels in this screen.

Table 97 PORT > LLDP > LLDP MED > LLDP-MED Location

LABEL	DESCRIPTION
Index	This lists the index number of the location configuration. Click an index number to view or edit the location.
Port	This lists the port number of the location configuration.
Location Coordinates	This field displays the location configuration information based on geographical coordinates that includes longitude, latitude, altitude and datum.
Civic Address	This field displays the Civic Address for the remote device using information such as Country, State, County, City, Street, Number, ZIP code and additional information.
ELIN Number	This field shows the Emergency Location Identification Number (ELIN), which is used to identify endpoint devices when they issue emergency call services. The valid length is form 10 to 25 characters.
	Select an entry's checkbox to select a specific entry. Otherwise, select the checkbox in the table heading row to select all entries.
Add/Edit	Click Add/Edit to add a new location or edit a selected one.
Delete	Select the locations that you want to remove, then click Delete .

32.10.1 Add/Edit LLDP-MED Location

To access this screen, click the **Add/Edit** button or select an entry from the list and click the **Add/Edit** button.

Figure 148 PORT > LLDP > LLDP MED > LLDP-MED Location > Add/Edit

Port	<input type="text"/>		
Location Coordinates			
Latitude	<input type="text"/> north ▾		
Longitude	<input type="text"/> west ▾		
Altitude	<input type="text"/> meters ▾		
Datum	WGS84 ▾		
Civic Address			
Country	<input type="text"/>	State	<input type="text"/>
County	<input type="text"/>	City	<input type="text"/>
Division	<input type="text"/>	Neighbor	<input type="text"/>
Street	<input type="text"/>	Leading-Street-Direction	<input type="text"/>
Street-Suffix	<input type="text"/>	Trailing-Street-Suffix	<input type="text"/>
House-Number	<input type="text"/>	House-Number-Suffix	<input type="text"/>
Landmark	<input type="text"/>	Additional-Location	<input type="text"/>
Name	<input type="text"/>	Zip-Code	<input type="text"/>
Building	<input type="text"/>	Unit	<input type="text"/>
Floor	<input type="text"/>	Room-Number	<input type="text"/>
Place-Type	<input type="text"/>	Postal-Community-Name	<input type="text"/>
Post-Office-Box	<input type="text"/>	Additional-Code	<input type="text"/>
ELIN			
ELIN Number	<input type="text"/>		
<input type="button" value="Apply"/> <input type="button" value="Clear"/> <input type="button" value="Cancel"/>			

The following table describes the labels in this screen.

Table 98 PORT > LLDP > LLDP MED > LLDP-MED Location > Add/Edit

LABEL	DESCRIPTION
Port	Enter the port number you want to set up the location within the LLDP-MED network.
Location Coordinates The LLDP-MED uses geographical coordinates and Civic Address to set the location information of the remote device. Geographical based coordinates includes latitude, longitude, altitude and datum. Civic Address includes Country, State, County, City, Street and other related information.	
Latitude	Enter the latitude information. The value should be from 0° to 90°. <ul style="list-style-type: none"> • north • south

Table 98 PORT > LLDP > LLDP MED > LLDP-MED Location > Add/Edit (continued)

LABEL	DESCRIPTION
Longitude	Enter the longitude information. The value should be from 0° to 180°. <ul style="list-style-type: none"> • west • east
Altitude	Enter the altitude information. The value should be from -2097151 to 2097151 in meters or in floors. <ul style="list-style-type: none"> • meters • floor
Datum	Select the appropriate geodetic datum used by GPS. <ul style="list-style-type: none"> • WGS84 • NAD83-NAVD88 • NAD83-MLLW
Civic Address	Enter the Civic Address by providing information such as Country, State, County, City, Street, Number, ZIP code and other additional information. Enter at least 2 fields in this configuration including the Country. The valid length of the Country field is 2 characters and all other fields are up to 32 characters. <ul style="list-style-type: none"> • Country • State • County • City • Division • Neighbor • Street • Leading-Street-Direction • Street-Suffix • Trailing-Street-Suffix • House-Number • House-Number-Suffix • Landmark • Additional-Location • Name • Zip-Code • Building • Unit • Floor • Room-Number • Place-Type • Postal-Community-Name • Post-Office-Box • Additional-Code
ELIN Number	Enter a numerical digit string, corresponding to the ELIN identifier which is used during emergency call setup to a traditional CAMA or ISDN trunk-based PSAP. The valid length is from 10 to 25 characters.
Apply	Click Apply to save your changes to the Switch's run-time memory. The Switch loses these changes if it is turned off or loses power, so use the Save link on the top navigation panel to save your changes to the non-volatile memory when you are done configuring.
Clear	Click Clear to clear the fields to the factory defaults.
Cancel	Click Cancel to not save the configuration you make and return to the last screen.

CHAPTER 33

PoE Setup

33.1 PoE Status (for PoE models only)

A powered device (PD) is a device such as an access point or a switch, that supports PoE (Power over Ethernet) so that it can receive power from another device through an Ethernet port.

In the figure below, the IP camera and IP phone get their power directly from the Switch. Aside from minimizing the need for cables and wires, PoE removes the hassle of trying to find a nearby electric outlet to power up devices.

Figure 149 Powered Device Examples

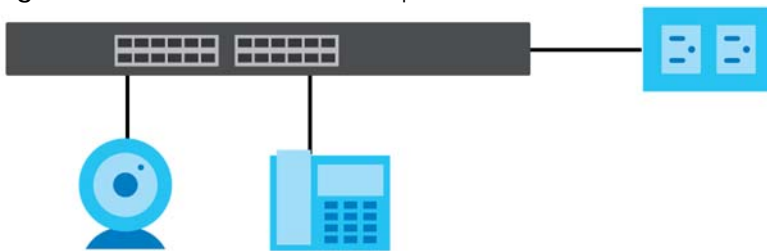

You can also set priorities so that the Switch is able to reserve and allocate power to certain PDs.

Note: The PoE (Power over Ethernet) devices that supply or receive power and their connected Ethernet cables must all be completely indoors.

To view the current amount of power that PDs are receiving from the Switch, click **PORT > PoE Setup > PoE Status**.

Figure 150 PORT > PoE Setup > PoE Status

PoE Status	PoE Setup	PoE Time Range Setup
PoE Mode	Consumption	
Total Power (W)	980.0	
PoE Usage (%)	0	
PoE Usage Threshold (%)	95	
Consuming Power (W)	0.0	
Allocated Power (W)	NA	
Remaining Power (W)	980.0	

Port	State	Class	Priority	Power-Up	Consuming Power (W)	Max Power (W)	Time-Range State
1	Enable	0	Low	802.3at	0.0	-	-
2	Enable	0	Low	802.3at	0.0	-	-
3	Enable	0	Low	802.3at	0.0	-	-
4	Enable	0	Low	802.3at	0.0	-	-
5	Enable	0	Low	802.3at	0.0	-	-
6	Enable	0	Low	802.3at	0.0	-	-
7	Enable	0	Low	802.3at	0.0	-	-
8	Enable	0	Low	802.3at	0.0	-	-
9	Enable	0	Low	802.3at	0.0	-	-

The following table describes the labels in this screen.

Table 99 PORT > PoE Setup > PoE Status

LABEL	DESCRIPTION
PoE Mode	This field displays the power management mode used by the Switch, whether it is in Classification or Consumption mode.
Total Power (W)	This field displays the total power the Switch can provide to the connected PoE-enabled devices on the PoE ports.
PoE Usage (%)	This field displays the amount of power currently being supplied to connected PoE devices (PDs) as a percentage of the total PoE power the Switch can supply. When PoE usage reaches 100%, the Switch will shut down PDs one-by-one according to the PD priority which you configured in PORT > PoE Setup > PoE Setup .
PoE Usage Threshold (%)	This field displays the percentage of PoE usage. The Switch will generate a trap and/or a log when the usage exceeds the specified threshold.
Consuming Power (W)	This field displays the amount of power the Switch is currently supplying to the connected PoE-enabled devices.
Allocated Power (W)	This field displays the total amount of power the Switch (in classification mode) has reserved for PoE after negotiating with the connected PoE devices. It shows NA when the Switch is in consumption mode. Consuming Power (W) can be less than or equal but not more than the Allocated Power (W) .
Remaining Power (W)	This field displays the amount of power the Switch can still provide for PoE.
Port	This is the port index number.
State	This field shows which ports can receive power from the Switch. <ul style="list-style-type: none"> • Disable – The PD connected to this port cannot get power supply. • Enable – The PD connected to this port can receive power.

Table 99 PORT > PoE Setup > PoE Status (continued)

LABEL	DESCRIPTION
Class	<p>This shows the power classification of the PD. Each PD has a specified maximum power that fall under one of the classes.</p> <p>The Class is a number from 0 to 6, where each value represents the range of power that the Switch provides to the PD. The power ranges in PoE standards are as follows.</p> <ul style="list-style-type: none"> • Class 0 – default: 0.44 W to 15.4 W. • Class 1 – default: 0.44 W to 4 W. • Class 2 – default: 0.44 W to 7 W. • Class 3 – default: 0.44 W to 15.4 W. • Class 4 – default: 0.44 W to 30 W. • Class 5 – default: 0.45 W to 45 W. • Class 6 – default: 0.45 W to 60 W. <p>Note: You can extend or set a limit on the maximum power the connected PD can use on a port in PORT > PoE Setup > PoE Setup.</p>
Priority	<p>When the total power requested by the PDs exceeds the total PoE power budget on the Switch, you can set the priority to allow the Switch to provide power to ports with higher priority first.</p> <ul style="list-style-type: none"> • Critical has the highest priority. • High has the Switch assign power to the port after all critical priority ports are served. • Low has the Switch assign power to the port after all critical and high priority ports are served.
Power-Up	This field displays the PoE standard the Switch uses to provide power on this port.
Consuming Power (W)	This field displays the current amount of power consumed by the PD from the Switch on this port.
Max Power (W)	This field displays the maximum amount of power the PD could use from the Switch on this port. This field displays “-” if the maximum power is not specified in PORT > PoE Setup > PoE Setup .
Time-Range State	<p>This field shows whether or not the port currently receives power from the Switch according to its schedule.</p> <ul style="list-style-type: none"> • It shows “In” followed by the time range name if PoE is currently enabled on the port. • It shows “Out” if PoE is currently disabled on the port. • It shows “-” if no schedule is applied to the port. PoE is enabled by default.

33.2 PoE Setup

Use this screen to set the PoE power management mode, priority levels, power-up mode and the maximum amount of power for the connected PDs.

Click the **PoE Setup** tab in the **PORT > PoE Setup** screen. The following screen opens.

Figure 151 PORT > PoE Setup > PoE Setup

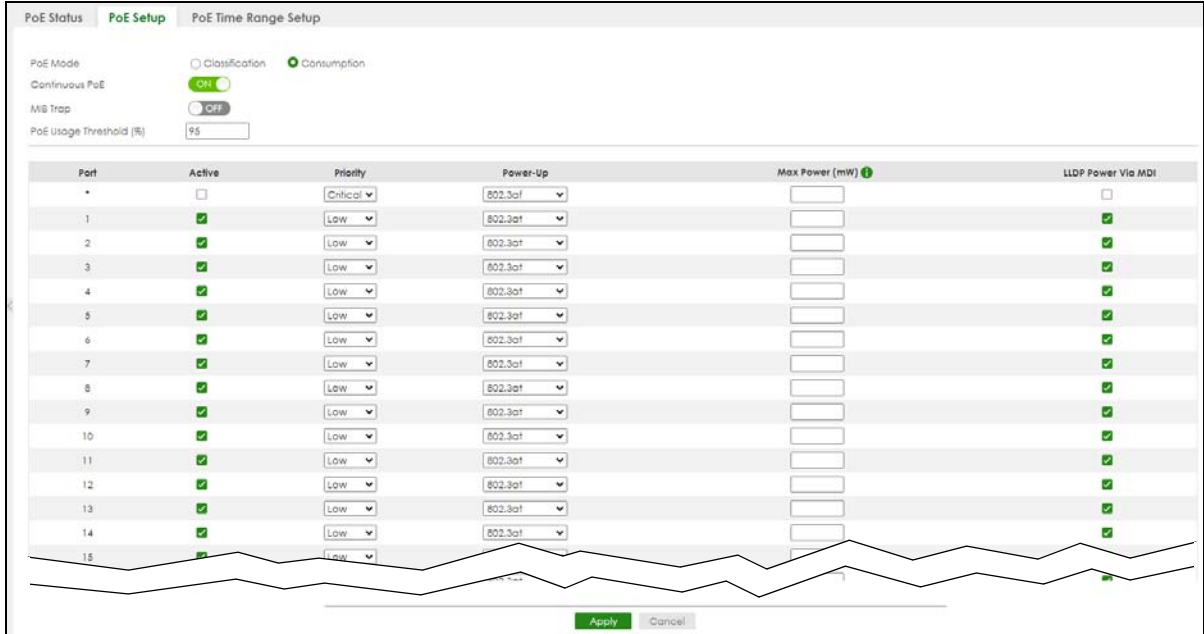

The following table describes the labels in this screen.

Table 100 PORT > PoE Setup > PoE Setup

LABEL	DESCRIPTION
PoE Mode	<p>Select the power management mode you want the Switch to use.</p> <ul style="list-style-type: none"> Classification – Select this if you want the Switch to reserve the maximum power for each PD according to the PD’s power class and priority level. If the total power supply runs out, PDs with lower priority do not get power to function. In this mode, the maximum power is reserved based on what you configure in Max Power or the standard power limit for each class. Consumption – Select this if you want the Switch to supply the actual power that the PD needs. The Switch also allocates power based on a port’s Max Power and the PD’s power class and priority level. The Switch puts a limit on the maximum amount of power the PD can request and use. In this mode, the default maximum power that can be delivered to the PD is 30 W (IEEE 802.3af Class 4) or 22 W (IEEE 802.3af Classes 0 to 3).
Continuous PoE	<p>Select ON to guarantee continuous power supply to the connected PDs while the Switch is restarting after a warm reboot. The Switch will NOT perform a power cycle on the connected PDs.</p> <p>If you do a cold reboot, the Switch also restarts the connected PDs.</p>
MIB Trap	<p>The Switch sends traps (monitoring event notification) to an SNMP (Simple Network Management Protocol) manager when an event occurs.</p> <p>Select ON to allow sending of MIB Trap when the following situations occur:</p> <ul style="list-style-type: none"> Situation 1 – Trap sent whenever a PoE port status change occurs (PoE port delivers power or delivers no power to a PD (powered device)) Situation 2 – Trap sent in cases where the total power usage exceeds the PoE usage threshold Situation 3 – Trap sent if total usage power decreases below the PoE usage threshold (only if previous total power usage exceeded the PoE usage threshold and a trap was sent). <p>Note: If the MIB Trap is ON, you must also configure:</p> <ul style="list-style-type: none"> SNMP trap destination (SYSTEM > SNMP > SNMP), SNMP trap group (SYSTEM > SNMP > SNMP Trap Group) and SNMP trap port (SYSTEM > SNMP > SNMP Trap Port) for Situation 1 SNMP trap destination and SNMP trap group for Situation 2 and Situation 3. <p>See Section 24.2 on page 148 for more information on configuring SNMP.</p>

Table 100 PORT > PoE Setup > PoE Setup (continued)

LABEL	DESCRIPTION
PoE Usage Threshold (%)	Enter a number ranging from 1 to 99 to set the threshold. The Switch will generate a trap and/or log when the actual PoE usage is higher than the specified threshold.
Port	This is the port index number.
*	<p>Settings in this row apply to all ports.</p> <p>Use this row only if you want to make some settings the same for all ports. Use this row first to set the common settings and then make adjustments on a port-by-port basis.</p> <p>Changes in this row are copied to all the ports as soon as you make them.</p>
Active	<p>Select this to provide power to a PD connected to the port.</p> <p>If left unchecked, the PD connected to the port cannot receive power from the Switch.</p>
Priority	<p>When the total power requested by the PDs exceeds the total PoE power budget on the Switch, you can set the PD priority to allow the Switch to provide power to ports with higher priority.</p> <p>Select Critical to give the highest PD priority on the port.</p> <p>Select High to set the Switch to assign the remaining power to the port after all critical priority ports are served.</p> <p>Select Low to set the Switch to assign the remaining power to the port after all critical and high priority ports are served.</p>
Power-Up	<p>Set how the Switch provides power to a connected PD at power-up.</p> <p>802.3af – the Switch follows the IEEE 802.3af Power over Ethernet standard to supply power to the connected PDs during power-up.</p> <p>Legacy – the Switch can provide power to the connected PDs that require high inrush currents at power-up. Inrush current is the maximum, instantaneous input current drawn by the PD when first turned on.</p> <p>Pre-802.3at – the Switch initially offers power on the port according to the IEEE 802.3af standard, and then switches to support the IEEE 802.3at standard within 75 milliseconds after a PD is connected to the port. Select this option if the Switch is performing 2-event Layer-1 classification (PoE+ hardware classification) or the connected PD is NOT performing Layer 2 power classification using Link Layer Discovery Protocol (LLDP).</p> <p>802.3at – the Switch supports the IEEE 802.3at High Power over Ethernet standard and can supply power of up to 30W per Ethernet port. IEEE 802.3at is also known as PoE+ or PoE Plus. An IEEE 802.3at compatible device is referred to as Type 2. Power Class 4 (High Power) can only be used by Type 2 devices. If the connected PD requires a Class 4 current when it is turned on, it will be powered up in this mode.</p> <p>Force-802.3at – the Switch offers power of up to 33 W on the port without performing PoE hardware classification. Select this option if the connected PD does not comply with any PoE standard and requests power higher than a standard power limit.</p>
Max Power (mW)	Specify the maximum amount of power the PD could use from the Switch on this port. If you leave this field blank, the Switch refers to the standard or default maximum power for each class.
LLDP Power Via MDI	<p>Select this to have the Switch negotiate PoE power with the PD connected to the port by transmitting LLDP Power Via MDI TLV frames. This helps the Switch allocate less power to the PD on this port. The connected PD must be able to request PoE power through LLDP.</p> <p>The Power Via MDI TLV allows PoE devices to advertise and discover the MDI power support capabilities of the sending port on the remote device.</p> <ul style="list-style-type: none"> • Port Class • MDI Supported • MDI Enabled • Pair Controllable • PSE Power Pairs • Power Class

Table 100 PORT > PoE Setup > PoE Setup (continued)

LABEL	DESCRIPTION
Apply	Click Apply to save your changes to the Switch's run-time memory. The Switch loses these changes if it is turned off or loses power, so use the Save link on the top navigation panel to save your changes to the non-volatile memory when you are done configuring.
Cancel	Click Cancel to begin configuring this screen afresh.

33.3 PoE Time Range Setup

Use this screen to apply a schedule to the ports on the Switch. You must first configure a schedule in the **SYSTEM > Time Range** screen.

Click the **PoE Time Range Setup** tab in the **PORT > PoE Setup** screen. The following screen opens.

Figure 152 PORT > PoE Setup > PoE Time Range Setup

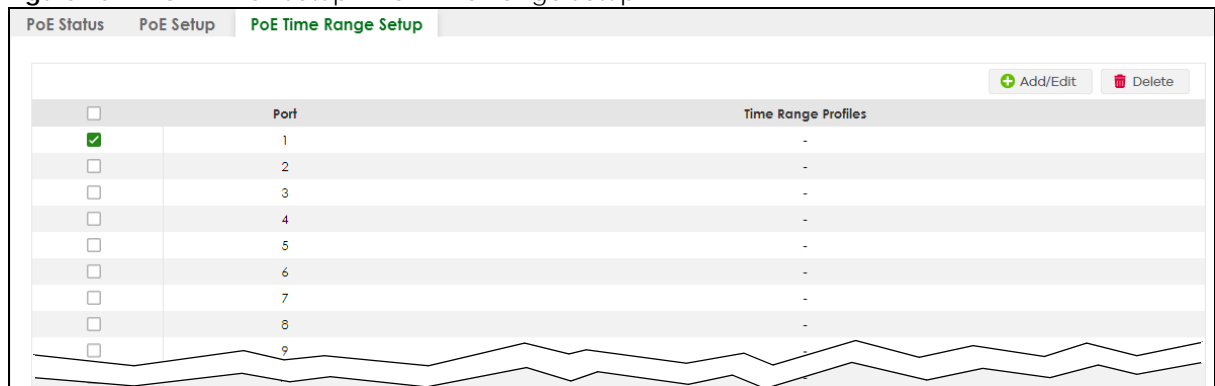

The following table describes the labels in this screen.

Table 101 PORT > PoE Setup > PoE Time Range Setup

LABEL	DESCRIPTION
Port	This field displays the index number of the port. Click a port number to change the schedule settings.
Time Range Profiles	This field displays the name of the schedule which is applied to the port. PoE is enabled at the specified time or date.
	Select an entry's checkbox to select a specific entry. Otherwise, select the checkbox in the table heading row to select all entries.
Add/Edit	Click Add/Edit to add a new rule or edit a selected one.
Delete	Check the rules that you want to remove and then click the Delete button.

33.3.1 Add/Edit PoE Time Range

To access this screen, click the **Add/Edit** button or select an entry from the list and click the **Add/Edit** button.

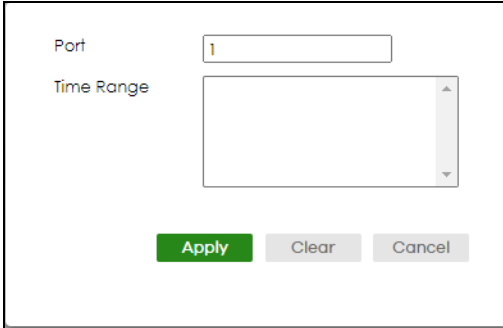
Figure 153 PORT > PoE Setup > PoE Time Range Setup > Add/Edit

The screenshot shows a configuration interface with two main input fields. The first field, labeled 'Port', contains the value '1'. The second field, labeled 'Time Range', is currently empty. Below these fields are three buttons: a green 'Apply' button, a grey 'Clear' button, and a grey 'Cancel' button.

The following table describes the labels in this screen.

Table 102 PORT > PoE Setup > PoE Time Range Setup > Add/Edit

LABEL	DESCRIPTION
Port	Enter the number of the port to which you want to apply a schedule.
Time Range	This field displays the name of the schedule that you have created using the SYSTEM > Time Range screen. Select a pre-defined schedule to control when the Switch enables PoE to provide power on the port. To select more than one schedule, press [SHIFT] and select the choices at the same time.
Apply	Click Apply to save your changes to the Switch's run-time memory. The Switch loses these changes if it is turned off or loses power, so use the Save link on the top navigation panel to save your changes to the non-volatile memory when you are done configuring.
Clear	Click Clear to clear the fields to the factory defaults.
Cancel	Click Cancel to not save the configuration you make and return to the last screen.

CHAPTER 34

Port Setup

34.1 Port Setup

Use this screen to configure Switch port settings. Click **PORT > Port Setup > Port Setup** in the navigation panel to display the configuration screen.

Figure 154 PORT > Port Setup

Port	Active	Name	Speed / Duplex	Extend Range	Flow Control	802.1p Priority
*	<input type="checkbox"/>	<input type="text"/>	Auto	<input type="checkbox"/>	<input type="checkbox"/>	0
1	<input checked="" type="checkbox"/>	<input type="text"/>	Auto	<input type="checkbox"/>	<input type="checkbox"/>	0
2	<input checked="" type="checkbox"/>	<input type="text"/>	Auto	<input type="checkbox"/>	<input type="checkbox"/>	0
3	<input checked="" type="checkbox"/>	<input type="text"/>	Auto	<input type="checkbox"/>	<input type="checkbox"/>	0
4	<input checked="" type="checkbox"/>	<input type="text"/>	Auto	<input type="checkbox"/>	<input type="checkbox"/>	0
5	<input checked="" type="checkbox"/>	<input type="text"/>	Auto	<input type="checkbox"/>	<input type="checkbox"/>	0
6	<input checked="" type="checkbox"/>	<input type="text"/>	Auto	<input type="checkbox"/>	<input type="checkbox"/>	0
7	<input checked="" type="checkbox"/>	<input type="text"/>	Auto	<input type="checkbox"/>	<input type="checkbox"/>	0
8	<input checked="" type="checkbox"/>	<input type="text"/>	Auto	<input type="checkbox"/>	<input type="checkbox"/>	0
9	<input checked="" type="checkbox"/>	<input type="text"/>	Auto	<input type="checkbox"/>	<input type="checkbox"/>	0
10	<input checked="" type="checkbox"/>	<input type="text"/>	Auto	<input type="checkbox"/>	<input type="checkbox"/>	0

The following table describes the labels in this screen.

Table 103 PORT > Port Setup

LABEL	DESCRIPTION
Port	This is the port index number.
*	<p>Settings in this row apply to all ports.</p> <p>Use this row only if you want to make some settings the same for all ports. Use this row first to set the common settings and then make adjustments on a port-by-port basis.</p> <p>Note: Changes in this row are copied to all the ports as soon as you make them.</p>
Active	Select this checkbox to enable a port. The factory default for all ports is enabled. A port must be enabled for data transmission to occur.

Table 103 PORT > Port Setup (continued)

LABEL	DESCRIPTION
Name	<p>Enter a descriptive name that identifies this port. You can enter up to 128 printable ASCII characters except [?], [], ['] or ["].</p> <p>Note: Due to space limitation, the port name may be truncated in some Web Configurator screens.</p>
Speed/Duplex	<p>Select the speed and the duplex mode of the Ethernet connection on this port. Choices are Auto, 10-an (10M/auto-negotiation), 10M/Half Duplex, 10M/Full Duplex, 100-an (100M/auto-negotiation), 100M/Half Duplex, 100M/Full Duplex and 1G/Full Duplex (Gigabit connections only).</p> <p>Selecting Auto (auto-negotiation) allows one port to negotiate with a peer port automatically to obtain the connection speed and duplex mode that both ends support. When auto-negotiation is turned on, a port on the Switch negotiates with the peer automatically to determine the connection speed and duplex mode. If the peer port does not support auto-negotiation or turns off this feature, the Switch determines the connection speed by detecting the signal on the cable and using half duplex mode. When the Switch's auto-negotiation is turned off, a port uses the pre-configured speed and duplex mode when making a connection, therefore requiring you to make sure that the settings of the peer port are the same in order to connect.</p>
Extended Range	<p>Select this checkbox to extend the PoE range up to 250 meters.</p> <p>After you enable this feature, the port will transfer data at a rate up to 10 Mbps in full duplex mode. If a PD is connected to the port, the Switch follows the IEEE 802.3at PoE+ standard to supply power to the connected PD during power-up.</p> <p>Note: Maximum PoE power that can be supplied to a PD at 250 m is 15 W.</p> <p>Note: If you enable extended range on a port after the connected PD starts up completely, you must disable PoE and enable it again or disconnect and reconnect the cable to the port for extended mode to take effect.</p> <p>Note: The port speed and duplex mode you previously configured will be applied automatically when the extend range feature is disabled.</p>
Flow Control	<p>A concentration of traffic on a port decreases port bandwidth and overflows buffer memory causing packet discards and frame losses. Flow Control is used to regulate transmission of signals to match the bandwidth of the receiving port.</p> <p>The Switch uses IEEE802.3x flow control in full duplex mode and backpressure flow control in half duplex mode.</p> <p>IEEE802.3x flow control is used in full duplex mode to send a pause signal to the sending port, causing it to temporarily stop sending signals when the receiving port memory buffers fill.</p> <p>Back Pressure flow control is typically used in half duplex mode to send a "collision" signal to the sending port (mimicking a state of packet collision) causing the sending port to temporarily stop sending signals and resend later. Select Flow Control to enable it.</p>
802.1p Priority	<p>This priority value is added to incoming frames without a (802.1p) priority queue tag. See Priority Queue Assignment in Section 43.2 on page 240 for more information.</p>
Apply	<p>Click Apply to save your changes to the Switch's run-time memory. The Switch loses these changes if it is turned off or loses power, so use the Save link on the top navigation panel to save your changes to the non-volatile memory when you are done configuring.</p>
Cancel	<p>Click Cancel to begin configuring this screen afresh.</p>

CHAPTER 35

SWITCHING

The following chapters introduces the configurations of the links under the **SWITCHING** navigation panel.

Quick links to chapters:

- [Loop Guard](#)
- [Mirroring](#)
- [Multicast](#)
- [Static Multicast Forwarding](#)
- [ONVIF](#)
- [Differentiated Services](#)
- [Queuing Method](#)
- [Priority Queue](#)
- [Bandwidth Control](#)
- [Spanning Tree Protocol](#)
- [Static MAC Filtering](#)
- [Static MAC Forwarding](#)
- [VLAN](#)

CHAPTER 36

Loop Guard

36.1 Loop Guard Overview

This chapter shows you how to configure the Switch to guard against loops on the edge of your network.

Loop guard allows you to configure the Switch to shut down a port if it detects that packets sent out on that port loop back to the Switch. While you can use Spanning Tree Protocol (STP) to prevent loops in the core of your network, STP cannot prevent loops that occur on the edge of your network.

Figure 155 Loop Guard vs. STP

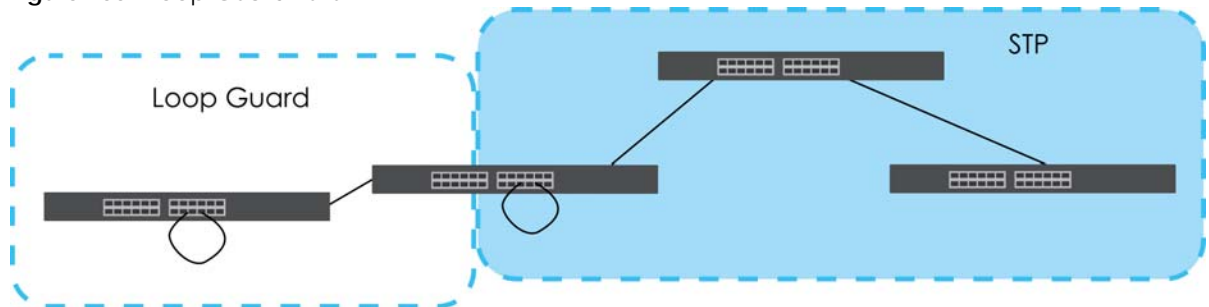

Refer to [Section 36.1.2 on page 216](#) for more information.

36.1.1 What You Can Do

Use the **Loop Guard** screen ([Section 36.2 on page 218](#)) to enable loop guard on the Switch and in specific ports.

36.1.2 What You Need to Know

Loop guard is designed to handle loop problems on the edge of your network. This can occur when a port is connected to a Switch that is in a loop state. Loop state occurs as a result of human error. It happens when two ports on a switch are connected with the same cable. When a switch in loop state sends out broadcast messages the messages loop back to the switch and are re-broadcast again and again causing a broadcast storm.

If a switch (not in loop state) connects to a switch in loop state, then it will be affected by the switch in loop state in the following way:

- The switch (not in loop state) will receive broadcast messages sent out from the switch in loop state.
- The switch (not in loop state) will receive its own broadcast messages that it sends out as they loop back. It will then re-broadcast those messages again.

The following figure shows port **N** on switch **A** connected to switch **B**. Switch **B** has two ports, **x** and **y**, mistakenly connected to each other. It forms a loop. When broadcast or multicast packets leave port **N** and reach switch **B**, they are sent back to port **N** on **A** as they are rebroadcast from **B**.

Figure 156 Switch in Loop State

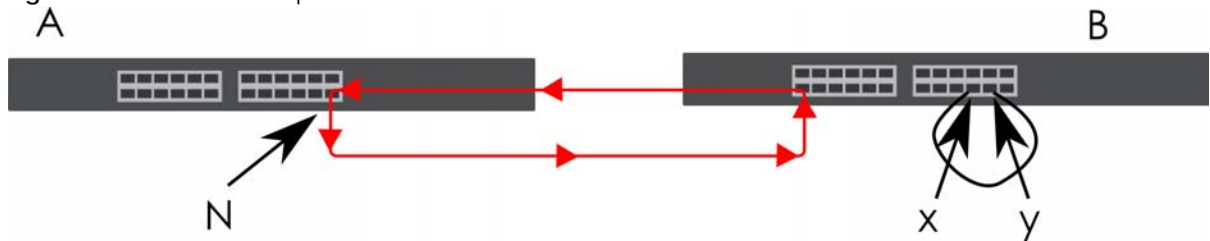

The loop guard feature checks to see if a loop guard enabled port is connected to a Switch in loop state. This is accomplished by periodically sending a probe packet and seeing if the packet returns on the same port. If this is the case, the Switch will shut down the port connected to the switch in loop state.

Loop guard can be enabled on both Ethernet ports. The following figure shows a loop guard enabled port **N** on switch **A** sending a probe packet **P** to switch **B**. Since switch **B** is in loop state, the probe packet **P** returns to port **N** on **A**. The Switch then shuts down port **N** to ensure that the rest of the network is not affected by the switch in loop state.

Figure 157 Loop Guard – Probe Packet

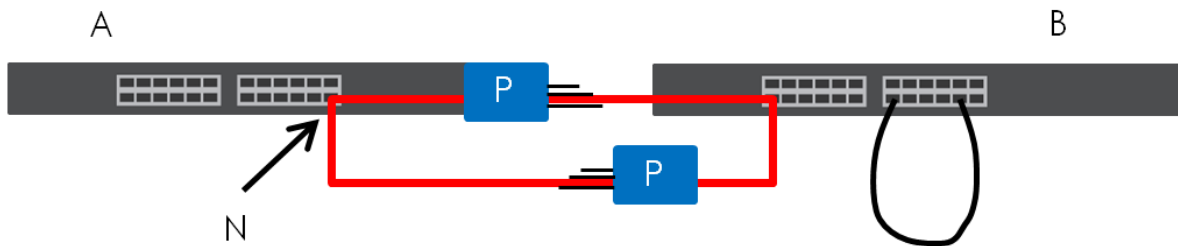

The Switch also shuts down port **N** if the probe packet returns to switch **A** on any other port. In other words loop guard also protects against standard network loops.

The following figure illustrates three switches forming a loop. A sample path of the loop guard probe packet is also shown. In this example, the probe packet is sent from port **N** and returns on another port. As long as loop guard is enabled on port **N**. The Switch will shut down port **N** if it detects that the probe packet has returned to the Switch.

Figure 158 Loop Guard – Network Loop

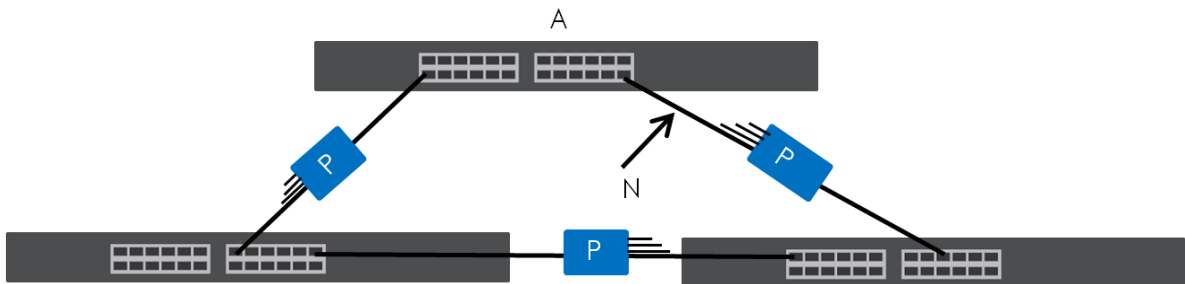

Note: After resolving the loop problem on your network you can re-activate the disabled port through the Web Configurator or through commands (See the CLI Reference Guide).

36.2 Loop Guard Setup

Click **SWITCHING** > **Loop Guard** in the navigation panel to display the screen as shown.

Note: The loop guard feature cannot be enabled on the ports that have Spanning Tree Protocol (RSTP) enabled.

Figure 159 SWITCHING > Loop Guard

Port	Active
*	<input type="checkbox"/>
1	<input type="checkbox"/>
2	<input type="checkbox"/>
3	<input type="checkbox"/>
4	<input type="checkbox"/>
5	<input type="checkbox"/>
6	<input type="checkbox"/>
7	<input type="checkbox"/>

The following table describes the labels in this screen.

Table 104 SWITCHING > Loop Guard

LABEL	DESCRIPTION
Active	Enable the switch button to activate loop guard function on the Switch. The Switch generates syslog, internal log messages as well as SNMP traps when it shuts down a port through the loop guard feature.
Port	This field displays the port number.
*	Settings in this row apply to all ports. Use this row only if you want to make some settings the same for all ports. Use this row first to set the common settings and then make adjustments on a port-by-port basis. Note: Changes in this row are copied to all the ports as soon as you make them.
Active	Select this checkbox to enable the loop guard feature on this port. The Switch sends broadcast and multicast probe packets from this port to check if the switch it is connected to is in loop state. If the switch that this port is connected to is in loop state the Switch will shut down this port. Clear this checkbox to disable the loop guard feature.
Apply	Click Apply to save your changes to the Switch's run-time memory. The Switch loses these changes if it is turned off or loses power, so use the Save link on the top navigation panel to save your changes to the non-volatile memory when you are done configuring.
Cancel	Click Cancel to begin configuring this screen afresh.

CHAPTER 37

Mirroring

37.1 Mirroring Overview

This chapter discusses port mirroring setup screens.

Port mirroring allows you to copy a traffic flow to a monitor port (the port you copy the traffic to) in order that you can examine the traffic from the monitor port without interference.

37.2 Port Mirroring Setup

Click **SWITCHING > Mirroring > Mirroring** in the navigation panel to display the **Mirroring** screen. Use this screen to select a monitor port and specify the traffic flow to be copied to the monitor port.

Figure 160 SWITCHING > Mirroring > Mirroring

Mirroring

Active OFF

Monitor Port

Port	Mirrored	Direction
*	<input type="checkbox"/>	ingress ▼
1	<input type="checkbox"/>	ingress ▼
2	<input type="checkbox"/>	ingress ▼
3	<input type="checkbox"/>	ingress ▼
4	<input type="checkbox"/>	ingress ▼
5	<input type="checkbox"/>	ingress ▼
6	<input type="checkbox"/>	ingress ▼
7	<input type="checkbox"/>	ingress ▼

Apply Cancel

The following table describes the labels in this screen.

Table 105 SWITCHING > Mirroring > Mirroring

LABEL	DESCRIPTION
Active	Enable the switch button to activate port mirroring on the Switch. Disable the switch to disable the feature.
Monitor Port	The monitor port is the port you copy the traffic to in order to examine it in more detail without interfering with the traffic flow on the original ports. Enter the port number of the monitor port.
Port	This field displays the port number.
*	<p>Settings in this row apply to all ports.</p> <p>Use this row only if you want to make some settings the same for all ports. Use this row first to set the common settings and then make adjustments on a port-by-port basis.</p> <p>Note: Changes in this row are copied to all the ports as soon as you make them.</p>
Mirrored	Select this option to mirror the traffic on a port.
Direction	Specify the direction of the traffic to mirror by selecting from the drop-down list box. Choices are Egress (outgoing), Ingress (incoming) and Both .
Apply	Click Apply to save your changes to the Switch's run-time memory. The Switch loses these changes if it is turned off or loses power, so use the Save link on the top navigation panel to save your changes to the non-volatile memory when you are done configuring.
Cancel	Click Cancel to reset the fields.

CHAPTER 38

Multicast

38.1 Multicast Overview

This chapter shows you how to configure various multicast features.

Traditionally, IP packets are transmitted in one of either two ways – Unicast (one sender to one recipient) or Broadcast (one sender to everybody on the network). Multicast delivers IP packets to just a group of hosts on the network.

IGMP (Internet Group Management Protocol) is a network-layer protocol used to establish membership in a multicast group – it is not used to carry user data. Refer to RFC 1112, RFC 2236 and RFC 3376 for information on IGMP versions 1, 2 and 3 respectively.

38.1.1 What You Can Do – IPv4 Multicast

- Use the **IPv4 Multicast Status** screen ([Section 38.2 on page 222](#)) to view IPv4 multicast group information.
- Use the **IGMP Snooping** screen ([Section 38.3 on page 223](#)) to enable IGMP snooping to forward group multicast traffic only to ports that are members of that group.
- Use the **IGMP Snooping VLAN** screen ([Section 38.4 on page 225](#)) to perform IGMP snooping on VLANs.

38.1.2 What You Need to Know

Read on for concepts on Multicasting that can help you configure the screens in this chapter.

IP Multicast Addresses

In IPv4, a multicast address allows a device to send packets to a specific group of hosts (multicast group) in a different subnetwork. A multicast IP address represents a traffic receiving group, not individual receiving devices. IP addresses in the Class D range (224.0.0.0 to 239.255.255.255) are used for IP multicasting. Certain IP multicast numbers are reserved by IANA for special purposes (see the IANA website for more information).

IGMP Snooping

A Switch can passively snoop on IGMP packets transferred between IP multicast routers or switches and IP multicast hosts to learn the IP multicast group membership. It checks IGMP packets passing through it, picks out the group registration information, and configures multicasting accordingly. IGMP snooping allows the Switch to learn multicast groups without you having to manually configure them.

The Switch forwards multicast traffic destined for multicast groups (that it has learned from IGMP

snooping or that you have manually configured) to ports that are members of that group. IGMP snooping generates no additional network traffic, allowing you to significantly reduce multicast traffic passing through your Switch.

IGMP Snooping and VLANs

The Switch can perform IGMP snooping on up to 16 VLANs. You can configure the Switch to automatically learn multicast group membership of any VLANs. The Switch then performs IGMP snooping on the first 16 VLANs that send IGMP packets. This is referred to as auto mode. Alternatively, you can specify the VLANs that IGMP snooping should be performed on. This is referred to as fixed mode. In fixed mode the Switch does not learn multicast group membership of any VLANs other than those explicitly added as an IGMP snooping VLAN.

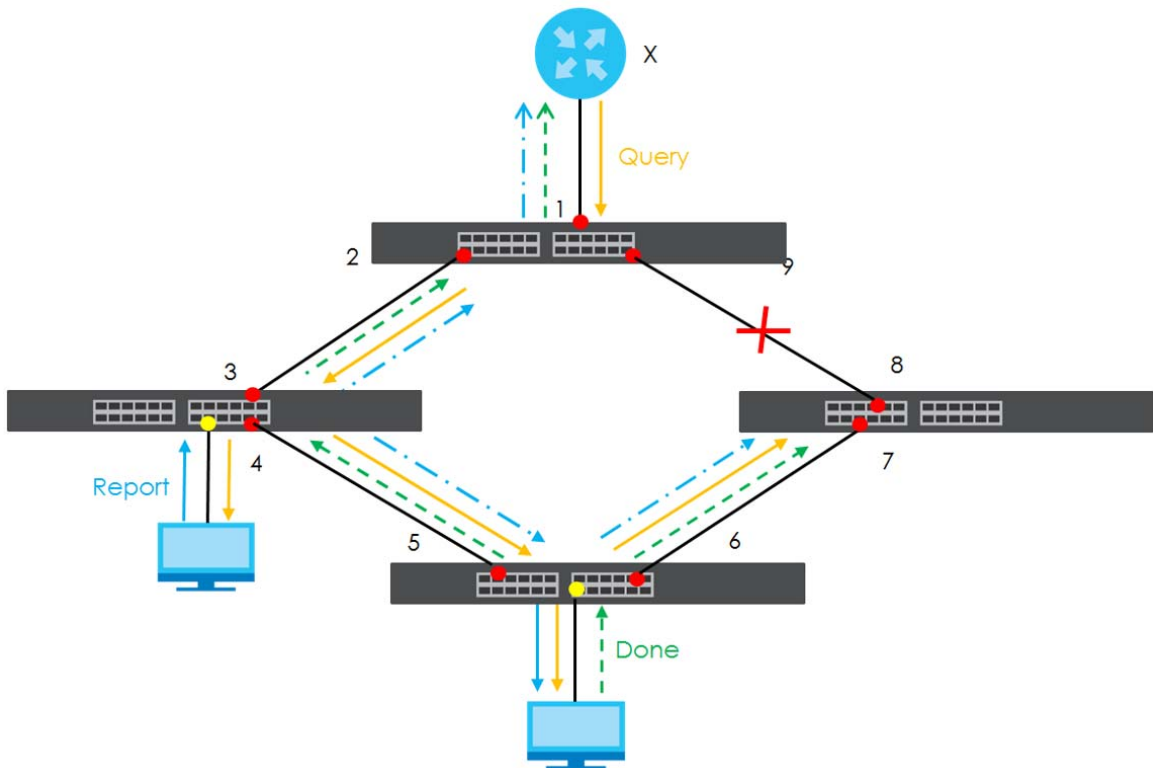

38.2 IPv4 Multicast Status

Click **SWITCHING > Multicast > IPv4 Multicast > IPv4 Multicast Status** to display the screen as shown. This screen shows the IPv4 multicast group information. See [Section 38.1 on page 221](#) for more information on multicasting.

Figure 161 SWITCHING > Multicast > IPv4 Multicast > IPv4 Multicast Status

IPv4 Multicast Status			
IGMP Snooping		IGMP Snooping VLAN	
Index	VID	Port	Multicast Group
1	1	18	224.0.0.251
2	1	18	224.0.0.252
3	1	18	239.255.255.250

The following table describes the labels in this screen.

Table 106 SWITCHING > Multicast > IPv4 Multicast > IPv4 Multicast Status

LABEL	DESCRIPTION
Index	This is the index number of the entry.
VID	This field displays the multicast VLAN ID.
Port	This field displays the port number that belongs to the multicast group.
Multicast Group	This field displays IP multicast group addresses.

38.3 IGMP Snooping

Click **SWITCHING > Multicast > IPv4 Multicast > IGMP Snooping** to display the screen as shown. See [Section 38.1 on page 221](#) for more information on multicasting.

Figure 162 SWITCHING > Multicast > IPv4 Multicast > IGMP Snooping

IPv4 Multicast Status			
IGMP Snooping		IGMP Snooping VLAN	
Active	<input checked="" type="checkbox"/>		
Querier	<input type="checkbox"/>		
Report Proxy	<input checked="" type="checkbox"/>		
Host Timeout	<input type="text" value="260"/>	seconds	
802.1p Priority	<input type="text" value="No-Change"/>		
Unknown Multicast Frame	<input checked="" type="radio"/> Flooding	<input type="radio"/> Drop	
Reserved Multicast Group	<input checked="" type="radio"/> Flooding	<input type="radio"/> Drop	
Port	Normal Leave	Fast Leave	IGMP Querier Mode
*	<input checked="" type="radio"/>	<input type="radio"/>	Auto
1	<input checked="" type="radio"/>	<input type="radio"/>	Auto
2	<input checked="" type="radio"/>	<input type="radio"/>	Auto
3	<input checked="" type="radio"/>	<input type="radio"/>	Auto
4	<input checked="" type="radio"/>	<input type="radio"/>	Auto
5	<input checked="" type="radio"/>	<input type="radio"/>	Auto
6	<input checked="" type="radio"/>	<input type="radio"/>	Auto
7	<input checked="" type="radio"/>	<input type="radio"/>	Auto
8	<input checked="" type="radio"/>	<input type="radio"/>	Auto
<input type="button" value="Apply"/> <input type="button" value="Cancel"/>			

The following table describes the labels in this screen.

Table 107 SWITCHING > Multicast > IPv4 Multicast > IGMP Snooping

LABEL	DESCRIPTION
Active	Enable the switch button to enable IGMP Snooping to forward group multicast traffic only to ports that are members of that group.
Querier	Select this to allow the Switch to send IGMP General Query messages to the VLANs with the multicast hosts attached.
Report Proxy	Select this to allow the Switch to act as the IGMP report proxy and leave proxy. It will report group changes to a connected multicast router. The Switch not only checks IGMP packets between multicast routers or switches and multicast hosts to learn the multicast group membership, but also replaces the source MAC address in an IGMP v1/v2 report with its own MAC address before forwarding to the multicast router or switch. When the Switch receives more than one IGMP v1/v2 join report that requests to join the same multicast group, it only sends a new join report with its MAC address. This helps reduce the number of multicast join reports passed to the multicast router or switch. The Switch sends a leave message with its MAC address to the multicast router or switch only when it receives the leave message from the last host in a multicast group.
Host Timeout	Specify the time (from 1 to 16711450) in seconds that elapses before the Switch removes an IGMP group membership entry if it does not receive report messages from the port.
802.1p Priority	Select a priority level (0 – 7) to which the Switch changes the priority in outgoing IGMP control packets. Otherwise, select No-Change to not replace the priority.
Unknown Multicast Frame	Specify the action to perform when the Switch receives an unknown multicast frame. Select Drop to discard the frames. Select Flooding to send the frames to all ports.
Reserved Multicast Group	The IP address range of 224.0.0.0 to 224.0.0.255 are reserved for multicasting on the local network only. For example, 224.0.0.1 is for all hosts on a local network segment and 224.0.0.9 is used to send RIP routing information to all RIP v2 routers on the same network segment. A multicast router will not forward a packet with the destination IP address within this range to other networks. See the IANA web site for more information. The layer-2 multicast MAC addresses used by Cisco layer-2 protocols, 01:00:0C:CC:CC:CC and 01:00:0C:CC:CC:CD, are also included in this group. Specify the action to perform when the Switch receives a frame with a reserved multicast address. <ul style="list-style-type: none"> Select Flooding to send the frames to all ports. Select Drop to discard the frames.
Use this section to configure IGMP Snooping on each port.	
Port	This field displays the port number.
*	Settings in this row apply to all ports. Use this row only if you want to make some settings the same for all ports. Use this row first to set the common settings and then make adjustments on a port-by-port basis. Changes in this row are copied to all the ports as soon as you make them.
Normal Leave	In normal leave mode, when the Switch receives an IGMP leave message from a host on a port, it forwards the message to the multicast router. The multicast router then sends out an IGMP Group-Specific Query (GSQ) message to determine whether other hosts connected to the port should remain in the specific multicast group. The Switch forwards the query message to all hosts connected to the port and waits for IGMP reports from hosts to update the forwarding table. This defines how many seconds the Switch waits for an IGMP report before removing an IGMP snooping membership entry when an IGMP leave message is received on this port from a host.

Table 107 SWITCHING > Multicast > IPv4 Multicast > IGMP Snooping (continued)

LABEL	DESCRIPTION
Fast Leave	<p>In fast leave mode, right after receiving an IGMP leave message from a host on a port, the Switch itself sends out an IGMP Group-Specific Query (GSQ) message to determine whether other hosts connected to the port should remain in the specific multicast group. This helps speed up the leave process.</p> <p>This defines how many seconds the Switch waits for an IGMP report before removing an IGMP snooping membership entry when an IGMP leave message is received on this port from a host.</p>
IGMP Querier Mode	<p>The Switch treats an IGMP query port as being connected to an IGMP multicast router (or server). The Switch forwards IGMP join or leave packets to an IGMP query port.</p> <p>Select Auto to have the Switch use the port as an IGMP query port if the port receives IGMP query packets.</p> <p>Select Fixed to have the Switch always use the port as an IGMP query port. Select this when you connect an IGMP multicast server to the port.</p> <p>Select Edge to stop the Switch from using the port as an IGMP query port. The Switch will not keep any record of an IGMP router being connected to this port. The Switch does not forward IGMP join or leave packets to this port.</p>
Apply	Click Apply to save your changes to the Switch's run-time memory. The Switch loses these changes if it is turned off or loses power, so use the Save link on the top navigation panel to save your changes to the non-volatile memory when you are done configuring.
Cancel	Click Cancel to begin configuring this screen afresh.

38.4 IGMP Snooping VLAN

Click **SWITCHING > Multicast > IPv4 Multicast > IGMP Snooping VLAN** to display the screen as shown. See [IGMP Snooping and VLANs on page 222](#) for more information on IGMP Snooping VLAN.

Note: You can perform IGMP snooping on up to 16 VLANs.

Figure 163 SWITCHING > Multicast > IPv4 Multicast > IGMP Snooping VLAN

The screenshot shows the configuration interface for IGMP Snooping VLAN. At the top, there are three tabs: 'IPv4 Multicast Status', 'IGMP Snooping', and 'IGMP Snooping VLAN'. The 'IGMP Snooping VLAN' tab is selected. Below the tabs, the title 'IGMP Snooping VLAN' is displayed. Underneath, there is a 'Mode' section with two radio buttons: 'auto' (which is selected) and 'fixed'. To the right of the mode selection are two buttons: 'Apply' and 'Cancel'. Below this is a section titled 'VLAN' which contains a table with three columns: 'Index', 'Name', and 'VID'. To the right of the table are two buttons: '+ Add/Edit' and 'Delete'.

The following table describes the labels in this screen.

Table 108 SWITCHING > Multicast > IPv4 Multicast > IGMP Snooping VLAN

LABEL	DESCRIPTION
IGMP Snooping VLAN	
Mode	<p>Select auto to have the Switch learn multicast group membership information of any VLANs automatically.</p> <p>Select fixed to have the Switch only learn multicast group membership information of the VLANs that you specify below.</p> <p>In either auto or fixed mode, the Switch can learn up to 16 VLANs.</p> <p>The Switch drops any IGMP control messages which do not belong to these 16 VLANs.</p> <p>You must also enable IGMP snooping in the SWITCHING > Multicast > IPv4 Multicast > IGMP Snooping screen first.</p>
Apply	Click Apply to save your changes to the Switch's run-time memory. The Switch loses these changes if it is turned off or loses power, so use the Save link on the top navigation panel to save your changes to the non-volatile memory when you are done configuring.
Cancel	Click Cancel to begin configuring this screen afresh.
VLAN	
Use this section of the screen to add VLANs on which the Switch is to perform IGMP snooping.	
Index	This is the index number of the IGMP snooping VLAN entry in the table.
Name	This field displays the descriptive name for this VLAN group.
VID	This field displays the ID number of the VLAN group.
	Select an entry's checkbox to select a specific entry. Otherwise, select the checkbox in the table heading row to select all entries.
Add/Edit	Click Add/Edit to create a new entry or edit a selected one.
Delete	Click Delete to remove the selected entries.

38.4.1 Add/Edit IGMP Snooping VLANs

This screen allows you to add an IGMP snooping VLAN or edit an existing one.

To access this screen, click the **Add/Edit** button or select an entry from the list and click the **Add/Edit** button.

Figure 164 SWITCHING > Multicast > IPv4 Multicast > IGMP Snooping VLAN > Add/Edit

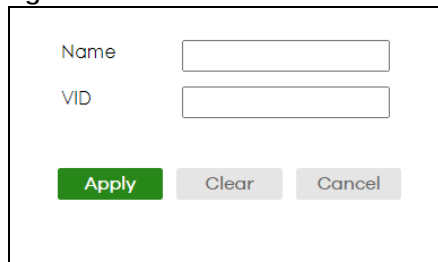

The screenshot shows a form with two input fields: "Name" and "VID". Below the fields are three buttons: "Apply" (green), "Clear" (grey), and "Cancel" (grey).

The following table describes the labels in this screen.

Table 109 SWITCHING > Multicast > IPv4 Multicast > IGMP Snooping VLAN > Add/Edit

LABEL	DESCRIPTION
Name	Enter the descriptive name of the VLAN for identification purposes. You can enter up to 32 printable ASCII characters except [?], [], ['], ["] or [.].
VID	Enter the ID of a static VLAN; the valid range is between 1 and 4094.
Apply	Click Apply to save your changes to the Switch's run-time memory. The Switch loses these changes if it is turned off or loses power, so use the Save link on the top navigation panel to save your changes to the non-volatile memory when you are done configuring.
Clear	Click Clear to clear the fields to the factory defaults.
Cancel	Click Cancel to not save the configuration you make and return to the last screen.

CHAPTER 39

Static Multicast Forwarding

39.1 Static Multicast Forwarding Overview

This chapter discusses how to configure static multicast forwarding rules based on multicast MAC addresses or multicast IPv4 addresses.

Use these screens to configure static multicast address forwarding by defining the ports and VLANs that multicast traffic can pass through the Switch. If a subscriber is on a different port or VLAN, then the subscriber will not get the multicast.

39.1.1 What You Can Do

Use the **Static Multicast Forwarding By MAC** screen ([Section 39.2 on page 229](#)) to configure rules to forward specific multicast frames, such as streaming or control frames, to specific ports.

39.1.2 What You Need To Know

A multicast MAC address or multicast IP address is the MAC address or IP address of a multicast group, and not a receiving device.

A static multicast address is a multicast MAC address or multicast IPv4 address that has been manually entered in the multicast table. This identifies the destination of the multicast content. Multicast IPv4 addresses use the Class D IP addresses range 224.0.0.0 to 239.255.255.255. Multicast MAC addresses have a "1" as the last binary bit of the first octet pair (for example, 01:00:5e:00:00:0A). Static multicast addresses do not age out. See [IP Multicast Addresses on page 221](#) for more information on IP multicast addresses.

Note: Static (manual) multicast forwarding allows you (the administrator) to forward multicast frames to a member without the member having to join the group first.

If a multicast group has no members, then the Switch cannot forward to specific ports unless you configure static (manual) multicast entries. The Switch will either flood the multicast frames to all ports (default) or drop them. [Figure 165 on page 229](#) shows such unknown multicast frames flooded to all ports. With static multicast forwarding, you can forward these multicasts to ports within a VLAN group.

Figure 165 No Multicast Forwarding

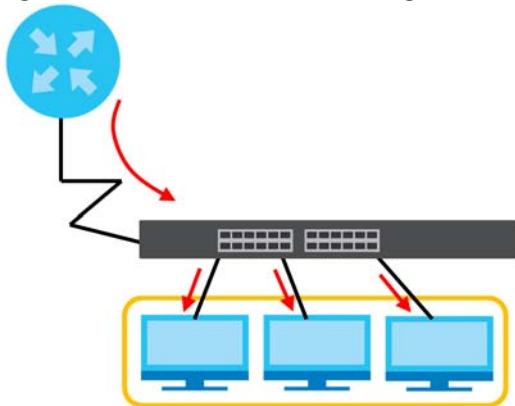

39.2 Static Multicast Forwarding By MAC

Use this screen to view and configure static multicast MAC addresses for ports to receive the multicast stream. Click **SWITCHING > Multicast > Static Multicast Forwarding By MAC** to display the screen as shown next.

Figure 166 SWITCHING > Multicast > Static Multicast Forwarding By MAC

Static Multicast Forwarding By MAC							
<input type="checkbox"/>	Index	Active	Name	MAC Address	VID	Port	
<input type="button" value="+ Add/Edit"/> <input type="button" value="Delete"/>							

The following table describes the labels in this screen.

Table 110 SWITCHING > Multicast > Static Multicast Forwarding By MAC

LABEL	DESCRIPTION
Index	This is the index number of the static multicast MAC address rule.
Active	This field displays whether a static multicast MAC address forwarding rule is active or not. You may temporarily deactivate a rule without deleting it.
Name	This field displays the descriptive name for identification purposes for a static multicast MAC address-forwarding rule.
MAC Address	This field displays the multicast MAC address that identifies a multicast group.
VID	This field displays the ID number of a VLAN group to which frames containing the specified multicast MAC address will be forwarded.
Port	This field displays the ports within an identified VLAN group to which frames containing the specified multicast MAC address will be forwarded.
	Select an entry's checkbox to select a specific entry. Otherwise, select the checkbox in the table heading row to select all entries.
Add/Edit	Click Add/Edit to add a new rule or edit a selected one.
Delete	Click Delete to remove the selected rules.

39.2.1 Add/Edit Static Multicast Forwarding By MAC

Use this screen to add a static multicast MAC address rule for ports to receive the multicast stream.

Click **Add/Edit**, or select an entry and click **Add/Edit** in the **SWITCHING > Multicast > Static Multicast Forwarding By MAC** to display this screen.

Figure 167 SWITCHING > Multicast > Static Multicast Forwarding By MAC > Add/Edit

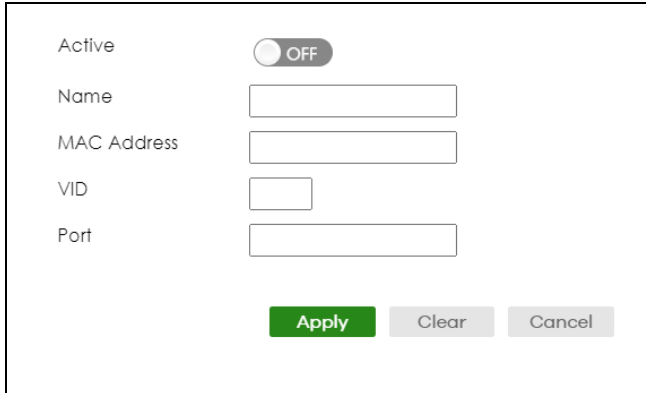

The following table describes the labels in this screen.

Table 111 SWITCHING > Multicast > Static Multicast Forwarding By MAC > Add/Edit

LABEL	DESCRIPTION
Active	Enable the switch button to activate your rule. You may temporarily deactivate a rule without deleting it by disabling the switch.
Name	Enter a descriptive name (up to 32 printable ASCII characters except [?], [], ['], ["] or [,]) for this static multicast MAC address forwarding rule. This is for identification only.
MAC Address	Enter a multicast MAC address which identifies the multicast group. The last binary bit of the first octet pair in a multicast MAC address must be 1. For example, the first octet pair 00000001 is 01 in hexadecimal, so 01:00:5e:00:00:0A and 01:00:5e:00:00:27 are valid multicast MAC addresses.
VID	You can forward frames with matching destination multicast MAC address to ports within a VLAN group. Enter the ID that identifies the VLAN group here. If you do NOT have a specific target VLAN, enter 1.
Port	Enter the ports where frames with destination multicast MAC address that matched the entry above are forwarded. You can enter multiple ports separated by (no space) comma (,) or hyphen (-). For example, enter "3-5" for ports 3, 4, and 5. Enter "3,5,7" for ports 3, 5, and 7.
Apply	Click Apply to save your changes to the Switch's run-time memory. The Switch loses these changes if it is turned off or loses power, so use the Save link on the top navigation panel to save your changes to the non-volatile memory when you are done configuring.
Clear	Click Clear to clear the fields to the factory defaults.
Cancel	Click Cancel to not save the configuration you make and return to the last screen.

CHAPTER 40

ONVIF

40.1 ONVIF Overview

IP-based security products use a specific protocol for communication. One of the most common protocols is ONVIF (Open Network Video Interface Forum). ONVIF is a standard interface for interoperability of IP-based security products.

When ONVIF is enabled and configured, the Switch can obtain information from connected ONVIF-compatible devices, such as a device's system name and IP address. This lets you know which ONVIF-compatible devices, for example IP cameras and NVR (network video recorders), are connected to the Switch.

40.1.1 What You Can Do

Use the **ONVIF** screen ([Section 40.2 on page 231](#)) to enable the ONVIF protocol on the Switch.

40.2 ONVIF

This screen lets you turn on the ONVIF protocol on the Switch and its Ethernet ports.

To open this screen, click **SWITCHING > ONVIF**.

Figure 168 SWITCHING > ONVIF

	Index	VID	Port
<input checked="" type="checkbox"/>	1	1	1-24

The following table describes the labels in this screen.

Table 112 SWITCHING > ONVIF

LABEL	DESCRIPTION
Active	Select Active to allow this Switch to send ONVIF packets to discover or scan for ONVIF-compatible IP-based security devices connected to its ports. Make sure to enter the port numbers in Port to allow discovery of ONVIF-compatible devices.
Apply	Click Apply to save your changes to the Switch's run-time memory. The Switch loses these changes if it is turned off or loses power, so use the Save link on the top navigation panel to save your changes to the non-volatile memory when you are done configuring.
Cancel	Click this to reset the values in this screen to their last-saved values.
VLAN	
	Select an entry's checkbox to select a specific entry. Otherwise, select the checkbox in the table heading row to select all entries.
Index	This is the index number of the ONVIF entry in the table.
VID	This field displays the VLAN to which the ports belong.
Port	This field displays the ports to which the Switch applies the settings.
Add/Edit	Click Add/Edit to add a new entry or edit a selected one.
Delete	Check the entries that you want to remove, then click the Delete button.

40.3 Add/Edit ONVIF Protocol

Click **Add/Edit**, or select an entry and click **Add/Edit** in the **SWITCHING > ONVIF** screen to display this screen.

Figure 169 SWITCHING > ONVIF > Add/Edit



The following table describes the labels in this screen.

Table 113 SWITCHING > ONVIF > Add/Edit

LABEL	DESCRIPTION
VID	Enter the ID number of the VLAN to run ONVIF.
Port	Enter the port numbers to allow discovery of ONVIF-compatible devices. You can enter multiple ports separated by comma (,) or hyphen (-) without spaces. For example, enter "3-5" for ports 3, 4, and 5. Enter "3,5,7" for ports 3, 5, and 7.
Apply	Click Apply to save your changes to the Switch's run-time memory. The Switch loses these changes if it is turned off or loses power, so use the Save link on the top navigation panel to save your changes to the non-volatile memory when you are done configuring.
Clear	Click Clear to reset the fields to the factory defaults.
Cancel	Click Cancel to reset the fields to your previous configuration.

CHAPTER 41

Differentiated Services

41.1 DiffServ Overview

This chapter shows you how to configure Differentiated Services (DiffServ) on the Switch.

Quality of Service (QoS) is used to prioritize source-to-destination traffic flows. All packets in the flow are given the same priority. You can use CoS (class of service) to give different priorities to different packet types.

DiffServ is a class of service (CoS) model that marks packets so that they receive specific per-hop treatment at DiffServ-compliant network devices along the route based on the application types and traffic flow. Packets are marked with DiffServ Code Points (DSCPs) indicating the level of service desired. This allows the intermediary DiffServ-compliant network devices to handle the packets differently depending on the code points without the need to negotiate paths or remember state information for every flow. In addition, applications do not have to request a particular service or give advanced notice of where the traffic is going.

41.1.1 What You Can Do

- Use the **Diffserv** screen ([Section 41.1 on page 233](#)) to activate DiffServ to apply marking rules or IEEE 802.1p priority mapping on the Switch.
- Use the **DSCP Setting** screen ([Section 41.3.1 on page 236](#)) to change the DSCP-IEEE 802.1p mapping.

41.1.2 What You Need to Know

Read on for concepts on Differentiated Services that can help you configure the screens in this chapter.

DSCP and Per-Hop Behavior

DiffServ defines a new DS (Differentiated Services) field to replace the Type of Service (ToS) field in the IP header. The DS field contains a 6-bit DSCP field which can define up to 64 service levels and the remaining 2 bits are defined as currently unused (CU). The following figure illustrates the DS field.

Figure 170 DiffServ: Differentiated Service Field

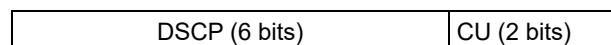

DSCP is backward compatible with the three precedence bits in the ToS octet so that non-DiffServ compliant, ToS-enabled network device will not conflict with the DSCP mapping.

The DSCP value determines the PHB (Per-Hop Behavior), that each packet gets as it is forwarded across the DiffServ network. Based on the marking rule different kinds of traffic can be marked for different

priorities of forwarding. Resources can then be allocated according to the DSCP values and the configured policies.

DiffServ Network Example

The following figure depicts a DiffServ network consisting of a group of directly connected DiffServ-compliant network devices. The boundary node (**A** in Figure 171) in a DiffServ network classifies (marks with a DSCP value) the incoming packets into different traffic flows (**Platinum, Gold, Silver, Bronze**) based on the configured marking rules. A network administrator can then apply various traffic policies to the traffic flows. An example traffic policy, is to give higher drop precedence to one traffic flow over others. In our example, packets in the **Bronze** traffic flow are more likely to be dropped when congestion occurs than the packets in the **Platinum** traffic flow as they move across the DiffServ network.

Figure 171 DiffServ Network

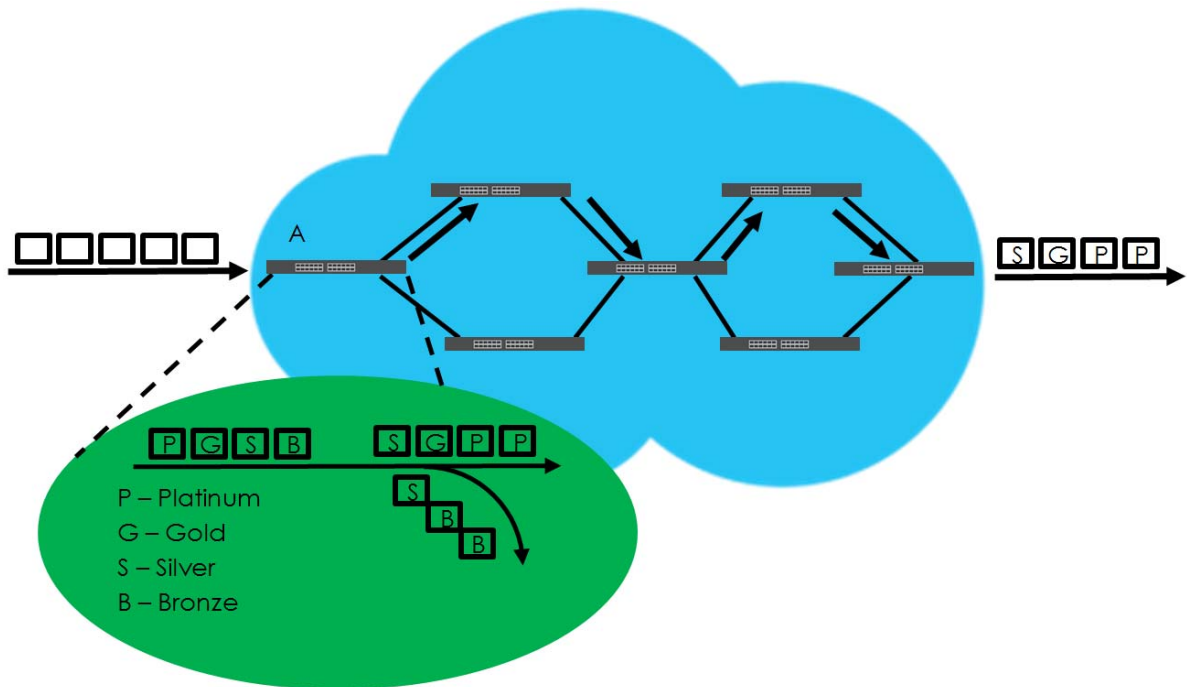

41.2 Activate DiffServ

Activate DiffServ to apply marking rules or IEEE 802.1p priority mapping on the selected ports.

Click **SWITCHING** > **QoS** > **Diffserv** to display the screen as shown.

Figure 172 SWITCHING > QoS > Diffserv

Port	Active
*	<input type="checkbox"/>
1	<input type="checkbox"/>
2	<input type="checkbox"/>
3	<input type="checkbox"/>
4	<input type="checkbox"/>
5	<input type="checkbox"/>
6	<input type="checkbox"/>
7	<input type="checkbox"/>

The following table describes the labels in this screen.

Table 114 SWITCHING > QoS > Diffserv

LABEL	DESCRIPTION
Active	Enable the switch button to enable Diffserv on the Switch.
Port	This field displays the index number of a port on the Switch.
*	Settings in this row apply to all ports. Use this row only if you want to make some settings the same for all ports. Use this row first to set the common settings and then make adjustments on a port-by-port basis. Changes in this row are copied to all the ports as soon as you make them.
Active	Select Active to enable Diffserv on the port.
Apply	Click Apply to save your changes to the Switch's run-time memory. The Switch loses these changes if it is turned off or loses power, so use the Save link on the top navigation panel to save your changes to the non-volatile memory when you are done configuring.
Cancel	Click Cancel to begin configuring this screen afresh.

41.3 DSCP-to-IEEE 802.1p Priority Settings

You can configure the DSCP to IEEE 802.1p mapping to allow the Switch to prioritize all traffic based on the incoming DSCP value according to the DiffServ to IEEE 802.1p mapping table.

The following table shows the default DSCP-to-IEEE802.1p mapping.

Table 115 Default DSCP-IEEE 802.1p Mapping

DSCP VALUE	0 – 7	8 – 15	16 – 23	24 – 31	32 – 39	40 – 47	48 – 55	56 – 63
IEEE 802.1p	0	1	2	3	4	5	6	7

41.3.1 Configure DSCP Settings

To change the DSCP-IEEE 802.1p mapping click **SWITCHING** > **QoS** > **Diffserv** > **DSCP Setting** to display the screen as shown next.

Figure 173 SWITCHING > QoS > Diffserv > DSCP Setting

The screenshot shows the 'DSCP Setting' configuration page. At the top, there are two tabs: 'Diffserv' and 'DSCP Setting'. Below the tabs is the title 'DSCP to 802.1p Mapping'. The main area contains a grid of 64 entries, each with a DSCP value and a corresponding 802.1p priority level. The values are: 0-7: 0; 8-15: 1; 16-23: 2; 24-31: 3; 32-39: 4; 40-47: 5; 48-55: 6; 56-63: 7. At the bottom, there are 'Apply' and 'Cancel' buttons.

The following table describes the labels in this screen.

Table 116 SWITCHING > QoS > Diffserv > DSCP Setting

LABEL	DESCRIPTION
0 ... 63	This is the DSCP classification identification number. To set the IEEE 802.1p priority mapping, select the priority level from the drop-down list box.
Apply	Click Apply to save your changes to the Switch's run-time memory. The Switch loses these changes if it is turned off or loses power, so use the Save link on the top navigation panel to save your changes to the non-volatile memory when you are done configuring.
Cancel	Click Cancel to begin configuring this screen afresh.

CHAPTER 42

Queuing Method

42.1 Queuing Method Overview

This section introduces the queuing methods supported.

Queuing is used to help solve performance degradation when there is network congestion. Use the **Queuing Method** screen to configure queuing algorithms for outgoing traffic. See also **Priority Queue Assignment** in the **SWITCHING > QoS > Priority Queue** screen and **802.1p Priority** in the **PORT > Port Setup** screen for related information.

42.1.1 What You Can Do

Use the **Queuing Method** screen ([Section 42.2 on page 238](#)) to set priorities for the queues of the Switch. This distributes bandwidth across the different traffic queues.

42.1.2 What You Need to Know

Queuing algorithms allow switches to maintain separate queues for packets from each individual source or flow and prevent a source from monopolizing the bandwidth.

Strictly Priority Queuing

Strictly Priority Queuing (SPQ) services queues based on priority only. As traffic comes into the Switch, traffic on the highest priority queue, Q7 is transmitted first. When that queue empties, traffic on the next highest-priority queue, Q6 is transmitted until Q6 empties, and then traffic is transmitted on Q5 and so on. If higher priority queues never empty, then traffic on lower priority queues never gets sent. SPQ does not automatically adapt to changing network requirements.

Weighted Fair Queuing

Weighted Fair Queuing is used to guarantee each queue's minimum bandwidth based on its bandwidth weight (portion) (the number you configure in the Weight field) when there is traffic congestion. WFQ is activated only when a port has more traffic than it can handle. Queues with larger weights get more guaranteed bandwidth than queues with smaller weights. This queuing mechanism is highly efficient in that it divides any available bandwidth across the different traffic queues. By default, the weight for Q0 is 1, for Q1 is 2, for Q2 is 3, and so on.

Weighted Round Robin Scheduling (WRR)

Round Robin Scheduling services queues on a rotating basis and is activated only when a port has more traffic than it can handle. A queue is given an amount of bandwidth irrespective of the incoming traffic

on that port. This queue then moves to the back of the list. The next queue is given an equal amount of bandwidth, and then moves to the end of the list; and so on, depending on the number of queues being used. This works in a looping fashion until a queue is empty.

Weighted Round Robin Scheduling (WRR) uses the same algorithm as round robin scheduling, but services queues based on their priority and queue weight (the number you configure in the queue **Weight** field) rather than a fixed amount of bandwidth. WRR is activated only when a port has more traffic than it can handle. Queues with larger weights get more service than queues with smaller weights. This queuing mechanism is highly efficient in that it divides any available bandwidth across the different traffic queues and returns to queues that have not yet emptied.

42.2 Configure Queuing

Use this screen to set priorities for the queues of the Switch. This distributes bandwidth across the different traffic queues.

Click **SWITCHING > QoS > Queuing Method** to display the screen as shown below.

Figure 174 SWITCHING > QoS > Queuing Method

Port	Method	Weight								Hybrid-SPQ Lowest-Queue	
		Q0	Q1	Q2	Q3	Q4	Q5	Q6	Q7		
*	SPQ										None
1	SPQ	1	2	3	4	5	6	7	8	None	
2	SPQ	1	2	3	4	5	6	7	8	None	
3	SPQ	1	2	3	4	5	6	7	8	None	
4	SPQ	1	2	3	4	5	6	7	8	None	
5	SPQ	1	2	3	4	5	6	7	8	None	
6	SPQ	1	2	3	4	5	6	7	8	None	
7	SPQ	1	2	3	4	5	6	7	8	None	

The following table describes the labels in this screen.

Table 117 SWITCHING > QoS > Queuing Method

LABEL	DESCRIPTION
Port	This label shows the port you are configuring.
*	<p>Settings in this row apply to all ports.</p> <p>Use this row only if you want to make some settings the same for all ports. Use this row first to set the common settings and then make adjustments on a port-by-port basis.</p> <p>Note: Changes in this row are copied to all the ports as soon as you make them.</p>

Table 117 SWITCHING > QoS > Queuing Method (continued)

LABEL	DESCRIPTION
Method	<p>Select SPQ (Strictly Priority Queuing), WFQ (Weighted Fair Queuing) or WRR (Weighted Round Robin).</p> <p>Strictly Priority Queuing services queues based on priority only. When the highest priority queue empties, traffic on the next highest-priority queue begins. Q7 has the highest priority and Q0 the lowest.</p> <p>Weighted Fair Queuing is used to guarantee each queue's minimum bandwidth based on their bandwidth portion (weight) (the number you configure in the Weight field). Queues with larger weights get more guaranteed bandwidth than queues with smaller weights.</p> <p>Weighted Round Robin Scheduling services queues on a rotating basis based on their queue weight (the number you configure in the queue Weight field). Queues with larger weights get more service than queues with smaller weights.</p>
Weight	When you select WFQ or WRR , enter the queue weight here. Bandwidth is divided across the different traffic queues according to their weights.
Hybrid-SPQ Lowest- Queue	<p>This field is applicable only when you select WFQ or WRR.</p> <p>Select a queue (Q0 to Q7) to have the Switch use SPQ to service the subsequent queues after and including the specified queue for the port. For example, if you select Q5, the Switch services traffic on Q5, Q6 and Q7 using SPQ.</p> <p>Select None to always use WFQ or WRR for the port.</p>
Apply	Click Apply to save your changes to the Switch's run-time memory. The Switch loses these changes if it is turned off or loses power, so use the Save link on the top navigation panel to save your changes to the non-volatile memory when you are done configuring.
Cancel	Click Cancel to begin configuring this screen afresh.

CHAPTER 43

Priority Queue

43.1 Priority Queue Overview

IEEE 802.1p defines up to eight separate traffic types by inserting a tag into a MAC-layer frame that contains bits to define class of service. Frames without an explicit priority tag are given the default priority of the ingress port. Use this screen to configure the priority level-to-physical queue mapping. The Switch has eight physical queues that you can map to the eight priority levels.

On the Switch, traffic assigned to higher index queues gets through faster while traffic in lower index queues is dropped if the network is congested.

43.1.1 What You Can Do

Use the **Priority Queue** screen ([Section 43.2 on page 240](#)) to configure the priority level-to-physical queue mapping.

43.2 Assign Priority Queue

Use this screen to assign priority level to each queue.

Click **SWITCHING** > **QoS** > **Priority Queue** to open this screen.

Figure 175 SWITCHING > QoS > Priority Queue

Priority Queue Assignment	
Priority7	7
Priority6	6
Priority5	5
Priority4	4
Priority3	3
Priority2	1
Priority1	0
Priority0	2

Apply Cancel

The following table describes the related labels in this screen.

Table 118 SWITCHING > QoS > Priority Queue

LABEL	DESCRIPTION
Priority Queue Assignment	The following descriptions are based on the traffic types defined in the IEEE 802.1d standard (which incorporates the 802.1p). To map a priority level to a physical queue, select a physical queue from the drop-down menu on the right.
Priority 7	Typically used for network control traffic such as router configuration messages.
Priority 6	Typically used for voice traffic that is especially sensitive to jitter (jitter is the variations in delay).
Priority 5	Typically used for video that consumes high bandwidth and is sensitive to jitter.
Priority 4	Typically used for controlled load, latency-sensitive traffic such as SNA (Systems Network Architecture) transactions.
Priority 3	Typically used for "excellent effort" or better than best effort and would include important business traffic that can tolerate some delay.
Priority 2	This is for "spare bandwidth".
Priority 1	This is typically used for non-critical "background" traffic such as bulk transfers that are allowed but that should not affect other applications and users.
Priority 0	Typically used for best-effort traffic.
Apply	Click Apply to save your changes to the Switch's run-time memory. The Switch loses these changes if it is turned off or loses power, so use the Save link on the top navigation panel to save your changes to the non-volatile memory when you are done configuring.
Cancel	Click Cancel to reset the fields.

CHAPTER 44

Bandwidth Control

44.1 Bandwidth Control Overview

This chapter shows you how you can cap the maximum bandwidth using the **Bandwidth Control** screen.

Bandwidth control means defining a maximum allowable bandwidth for incoming and/or out-going traffic flows on a port.

44.1.1 What You Can Do

Use the **Bandwidth Control** screen ([Section 44.2 on page 242](#)) to limit the bandwidth for traffic going through the Switch.

44.2 Bandwidth Control Setup

Click **SWITCHING > QoS > Bandwidth Control** in the navigation panel to bring up the screen as shown next.

Figure 176 SWITCHING > QoS > Bandwidth Control

Bandwidth Control

Active ON

Port	Active	Ingress Rate	Active	Egress Rate
*	<input type="checkbox"/>	<input type="text"/> kbps	<input type="checkbox"/>	<input type="text"/> kbps
1	<input type="checkbox"/>	<input type="text" value="64"/> kbps	<input type="checkbox"/>	<input type="text" value="64"/> kbps
2	<input type="checkbox"/>	<input type="text" value="64"/> kbps	<input type="checkbox"/>	<input type="text" value="64"/> kbps
3	<input type="checkbox"/>	<input type="text" value="64"/> kbps	<input type="checkbox"/>	<input type="text" value="64"/> kbps
4	<input type="checkbox"/>	<input type="text" value="64"/> kbps	<input type="checkbox"/>	<input type="text" value="64"/> kbps
5	<input type="checkbox"/>	<input type="text" value="64"/> kbps	<input type="checkbox"/>	<input type="text" value="64"/> kbps
6	<input type="checkbox"/>	<input type="text" value="64"/> kbps	<input type="checkbox"/>	<input type="text" value="64"/> kbps
7	<input type="checkbox"/>	<input type="text" value="64"/> kbps	<input type="checkbox"/>	<input type="text" value="64"/> kbps
8	<input type="checkbox"/>	<input type="text" value="64"/> kbps	<input type="checkbox"/>	<input type="text" value="64"/> kbps

The following table describes the related labels in this screen.

Table 119 SWITCHING > QoS > Bandwidth Control

LABEL	DESCRIPTION
Active	Enable the switch button to enable bandwidth control on the Switch.
Port	This field displays the port number.
*	<p>Settings in this row apply to all ports.</p> <p>Use this row only if you want to make some settings the same for all ports. Use this row first to set the common settings and then make adjustments on a port-by-port basis.</p> <p>Note: Changes in this row are copied to all the ports as soon as you make them.</p>
Active	Select this checkbox to activate ingress rate limits on this port.
Ingress Rate	<p>Specify the maximum bandwidth allowed in kilobits per second (Kbps) for the incoming traffic flow on a port.</p> <p>Note: Ingress rate bandwidth control applies to layer 2 traffic only.</p>
Active	Select this checkbox to activate egress rate limits on this port.
Egress Rate	Specify the maximum bandwidth allowed in kilobits per second (Kbps) for the out-going traffic flow on a port.
Apply	Click Apply to save your changes to the Switch's run-time memory. The Switch loses these changes if it is turned off or loses power, so use the Save link on the top navigation panel to save your changes to the non-volatile memory when you are done configuring.
Cancel	Click Cancel to reset the fields.

CHAPTER 45

Spanning Tree Protocol

45.1 Spanning Tree Protocol Overview

The Switch supports Spanning Tree Protocol (STP) and Rapid Spanning Tree Protocol (RSTP) as defined in the following standards.

- IEEE 802.1D Spanning Tree Protocol
- IEEE 802.1w Rapid Spanning Tree Protocol

45.1.1 What You Can Do

- Use the **Spanning Tree Setup** screen ([Section 45.3 on page 246](#)) to activate one of the STP modes on the Switch.
- Use the **Rapid Spanning Tree Protocol Status** screen ([Section 45.4 on page 248](#)) to view the RSTP status.
- Use the **Rapid Spanning Tree Protocol** screen ([Section 45.5 on page 250](#)) to configure RSTP settings.

45.1.2 What You Need to Know

Read on for concepts on STP that can help you configure the screens in this chapter.

(Rapid) Spanning Tree Protocol

(R)STP detects and breaks network loops and provides backup links between switches, bridges or routers. It allows a switch to interact with other (R)STP-compliant switches in your network to ensure that only one path exists between any two stations on the network.

The Switch uses IEEE 802.1w RSTP (Rapid Spanning Tree Protocol) that allows faster convergence of the spanning tree than STP (while also being backwards compatible with STP-only aware bridges). In RSTP, topology change information is directly propagated throughout the network from the device that generates the topology change. In STP, a longer delay is required as the device that causes a topology change first notifies the root bridge that then notifies the network. Both RSTP and STP flush unwanted learned addresses from the filtering database. In RSTP, the port states are Discarding, Learning, and Forwarding.

Note: In this user's guide, "STP" refers to both STP and RSTP.

STP Terminology

The root bridge is the base of the spanning tree.

Path cost is the cost of transmitting a frame onto a LAN through that port. The recommended cost is assigned according to the speed of the link to which a port is attached. The slower the media, the

higher the cost.

Table 120 STP Path Costs

	LINK SPEED	RECOMMENDED VALUE	RECOMMENDED RANGE	ALLOWED RANGE
Path Cost	4 Mbps	250	100 to 1000	1 to 65535
Path Cost	10 Mbps	100	50 to 600	1 to 65535
Path Cost	16 Mbps	62	40 to 400	1 to 65535
Path Cost	100 Mbps	19	10 to 60	1 to 65535
Path Cost	1 Gbps	4	3 to 10	1 to 65535
Path Cost	10 Gbps	2	1 to 5	1 to 65535

On each bridge, the root port is the port through which this bridge communicates with the root. It is the port on this switch with the lowest path cost to the root (the root path cost). If there is no root port, then this switch has been accepted as the root bridge of the spanning tree network.

For each LAN segment, a designated bridge is selected. This bridge has the lowest cost to the root among the bridges connected to the LAN.

How STP Works

After a bridge determines the lowest cost-spanning tree with STP, it enables the root port and the ports that are the designated ports for connected LANs, and disables all other ports that participate in STP. Network packets are therefore only forwarded between enabled ports, eliminating any possible network loops.

STP-aware switches exchange Bridge Protocol Data Units (BPDUs) periodically. When the bridged LAN topology changes, a new spanning tree is constructed.

Once a stable network topology has been established, all bridges listen for Hello BPDUs (Bridge Protocol Data Units) transmitted from the root bridge. If a bridge does not get a Hello BPDU after a predefined interval (Max Age), the bridge assumes that the link to the root bridge is down. This bridge then initiates negotiations with other bridges to reconfigure the network to re-establish a valid network topology.

STP Port States

STP assigns five port states to eliminate packet looping. A bridge port is not allowed to go directly from blocking state to forwarding state so as to eliminate transient loops.

Table 121 STP Port States

PORT STATE	DESCRIPTION
Disabled	STP is disabled (default).
Blocking	Only configuration and management BPDUs are received and processed.
Listening	All BPDUs are received and processed. Note: The listening state does NOT exist in RSTP.
Learning	All BPDUs are received and processed. Information frames are submitted to the learning process but not forwarded.
Forwarding	All BPDUs are received and processed. All information frames are received and forwarded.

45.2 Spanning Tree Protocol Status

Click **SWITCHING** > **Spanning Tree Protocol** > **Spanning Tree Protocol Status** to see the screen as shown.

Figure 177 SWITCHING > Spanning Tree Protocol > Spanning Tree Protocol Status

Spanning Tree Protocol Status					
Spanning Tree Protocol: RSTP					
	Root Bridge		Our Bridge		
Bridge ID	0000-000000000000		0000-000000000000		
Hello Time (seconds)	0		0		
Max Age (seconds)	0		0		
Forwarding Delay (seconds)	0		0		
Cost to Bridge	0		0		
Port ID	0x0000				
Topology Changed Times	0				
Time Since Last Change	0:00:00				
Port	Port State	Port Role	Designated Bridge ID	Designated Port ID	Designated Cost

45.3 Spanning Tree Setup

There are three **Auto path-cost Modes** (see [Table 125 on page 248](#)). Choose the **Auto Path-cost Mode** according to the device average link speeds in the STP network.

If most of your devices support high link speed, you should select **Long** or **User-defined** mode. The path cost of link speed slower than 10 Mbps can be set to 2000000, and the path cost of link speed faster than 10 Gbps can be set to 200. This way, the path costs can better reflect actual link speeds with a wider range (32 bits) of path cost values. If the link speeds within the system are averagely smaller than 1 Gbps, you should select **Short** mode since **Short** mode have path cost values more detailed defined for link speeds under 1 Gbps.

The path cost values are described in the following tables.

The Switch defines the following **Short** mode path costs.

Table 122 Auto Path Cost Mode: Short

LINK SPEED	AUTO PATH COST VALUE
Up to 4 Mbps	250
Up to 10 Mbps	100
Up to 16 Mbps	62
Up to 100 Mbps	19
Up to 1 Gbps	4
Up to 10 Gbps	2
More than 10 Gbps	1

The Switch defines the following **Long** mode path costs.

Table 123 Auto Path Cost Mode: Long

LINK SPEED	AUTO PATH COST VALUE
Up to 10 Mbps	2000000
Up to 100 Mbps	200000
Up to 1 Gbps	20000
Up to 2.5 Gbps	8000
Up to 5 Gbps	4000
Up to 10 Gbps	2000
More than 10 Gbps	200

If you do not configure the auto path cost values for **User-defined** mode, the Switch uses the following default values.

Table 124 Auto Path Cost Mode: User-defined

LINK SPEED	AUTO PATH COST VALUE
Up to 10 Mbps	2000000
Up to 100 Mbps	200000
Up to 1 Gbps	20000
Up to 2.5 Gbps	8000
Up to 5 Gbps	4000
More than 5 Gbps	2000

Click **SWITCHING** > **Spanning Tree Protocol** > **Spanning Tree Setup** to display the screen as shown.

Figure 178 SWITCHING > Spanning Tree Protocol > Spanning Tree Setup

Spanning Tree Setup

Spanning Tree Mode

Rapid Spanning Tree (RSTP)

Auto Path-cost Mode

Short

Long

User-defined:

10M

100M

1G

The following table describes the labels in this screen.

Table 125 SWITCHING > Spanning Tree Protocol > Spanning Tree Setup

LABEL	DESCRIPTION
Spanning Tree Mode	The Rapid Spanning Tree (RSTP) STP mode is activated by default.
Auto Path-cost Mode	<p>Auto Path-cost Mode allows you to have the Switch automatically set the path cost for each port according to their link speed. The Switch uses the path costs to determine the best path to the root bridge in a spanning tree. There are three Auto Path-cost Modes that supports different path cost lengths:</p> <ul style="list-style-type: none"> • Short (16-bit) • Long (32-bit) • User-defined (32-bit). <p>The auto path cost values of each mode are described in Section 45.3 on page 246.</p> <p>Note: It is recommended to use the same Auto Path-cost Mode on all switches within the spanning tree network system.</p> <p>To use the auto path-cost feature, select the Auto Path-cost mode (Short, Long, User-defined), set a port's Path Cost (in the SWITCHING > Spanning Tree Protocol > RSTP screen) to "0". The Switch will automatically set the port's path cost to the auto path cost value defined by the Auto Path-cost Mode you select.</p>
Short	Select this mode if you want to use the 16-bit auto path cost values the Switch defines.
Long	Select this mode if you want to use the 32-bit auto path cost values the Switch defines.
User-defined	Select this mode to manually set the auto path costs for each link speed. Enter the path cost value for each link speed. The range is from 1 – 2000000. It is recommended to assign this value according to link speeds. The slower the speed, the higher the cost.
Apply	Click Apply to save your changes to the Switch's run-time memory. The Switch loses these changes if it is turned off or loses power, so use the Save link on the top navigation panel to save your changes to the non-volatile memory when you are done configuring.
Cancel	Click Cancel to begin configuring this screen afresh.

45.4 Rapid Spanning Tree Protocol Status

Click **SWITCHING > Spanning Tree Protocol > Spanning Tree Protocol Status** in the navigation panel to display the status screen as shown next. See [Section 45.1 on page 244](#) for more information on RSTP.

Figure 179 SWITCHING > Spanning Tree Protocol > Spanning Tree Protocol Status: RSTP

Spanning Tree Protocol Status					
Spanning Tree Protocol: RSTP					
	Root Bridge		Our Bridge		
Bridge ID	0000-000000000000		0000-000000000000		
Hello Time (seconds)	0		0		
Max Age (seconds)	0		0		
Forwarding Delay (seconds)	0		0		
Cost to Bridge	0				
Port ID	0x0000				
Topology Changed Times	0				
Time Since Last Change	0:00:00				
Port	Port State	Port Role	Designated Bridge ID	Designated Port ID	Designated Cost

The following table describes the labels in this screen.

Table 126 SWITCHING > Spanning Tree Protocol > Spanning Tree Protocol Status: RSTP

LABEL	DESCRIPTION
Spanning Tree Protocol: RSTP	
Bridge	Root Bridge refers to the base of the spanning tree (the root bridge). Our Bridge is this Switch. This Switch may also be the root bridge.
Bridge ID	This is the unique identifier for this bridge, consisting of bridge priority plus MAC address. This ID is the same for Root Bridge and Our Bridge if the Switch is the root switch.
Hello Time (seconds)	This is the time interval (in seconds) at which the root switch transmits a configuration message. The root bridge determines Hello Time , Max Age and Forwarding Delay .
Max Age (seconds)	This is the maximum time (in seconds) the Switch can wait without receiving a configuration message before attempting to reconfigure.
Forwarding Delay (seconds)	This is the time (in seconds) the root switch will wait before changing states (that is, listening to learning to forwarding). Note: The listening state does NOT exist in RSTP.
Cost to Bridge	This is the path cost from the root port on this Switch to the root switch.
Port ID	This is the priority and number of the port on the Switch through which this Switch must communicate with the root of the Spanning Tree.
Topology Changed Times	This is the number of times the spanning tree has been reconfigured.
Time Since Last Change	This is the time since the spanning tree was last reconfigured.
Port	This field displays the number of the port on the Switch.
Port State	This field displays the port state in STP. <ul style="list-style-type: none"> • DISCARDING – The port does not forward or process received frames or learn MAC addresses, but still listens for BPDUs. • LEARNING – The port learns MAC addresses and processes BPDUs, but does NOT forward frames yet. • FORWARDING – The port is operating normally. It learns MAC addresses, processes BPDUs and forwards received frames.
Port Role	This field displays the role of the port in STP. <ul style="list-style-type: none"> • Root – A forwarding port on a non-root bridge, which has the lowest path cost and is the best port from the non-root bridge to the root bridge. A root bridge does NOT have a root port. • Designated – A forwarding port on the designated bridge for each connected LAN segment. A designated bridge has the lowest path cost to the root bridge among the bridges connected to the LAN segment. All the ports on a root bridge (root switch) are designated ports. • Alternate – A blocked port, which has a best alternate path to the root bridge. This path is different from using the root port. The port moves to the forwarding state when the designated port for the LAN segment fails. • Backup – A blocked port, which has a backup or redundant path to a LAN segment where a designated port is already connected when a switch has two links to the same LAN segment. • Disabled – Not strictly part of STP. The port can be disabled manually.
Designated Bridge ID	This field displays the identifier of the designated bridge to which this port belongs when the port is a designated port. Otherwise, it displays the identifier of the designated bridge for the LAN segment to which this port is connected.
Designated Port ID	This field displays the priority and number of the bridge port (on the designated bridge), through which the designated bridge transmits the stored configuration messages.
Designated Cost	This field displays the path cost to the LAN segment to which the port is connected when the port is a designated port. Otherwise, it displays the path cost to the root bridge from the designated port for the LAN segment to which this port is connected.

45.5 Configure Rapid Spanning Tree Protocol

Use this screen to configure RSTP settings, see [Section 45.1 on page 244](#) for more information on RSTP. Click **SWITCHING** > **Spanning Tree Protocol** > **RSTP** in the navigation panel to display the screen as shown.

Figure 180 SWITCHING > Spanning Tree Protocol > RSTP

Port	Active	Edge	Priority	Path Cost
*	<input type="checkbox"/>	<input type="checkbox"/>	<input type="text"/>	<input type="text"/>
1	<input type="checkbox"/>	<input type="checkbox"/>	128	4
2	<input type="checkbox"/>	<input type="checkbox"/>	128	4
3	<input type="checkbox"/>	<input type="checkbox"/>	128	4
4	<input type="checkbox"/>	<input type="checkbox"/>	128	4
5	<input type="checkbox"/>	<input type="checkbox"/>	128	4
6	<input type="checkbox"/>	<input type="checkbox"/>	128	4
7	<input type="checkbox"/>	<input type="checkbox"/>	128	4
8	<input type="checkbox"/>	<input type="checkbox"/>	128	4

The following table describes the labels in this screen.

Table 127 SWITCHING > Spanning Tree Protocol > RSTP

LABEL	DESCRIPTION
Active	Enable the switch button to activate RSTP. Disable the switch to disable RSTP.
Bridge Priority	<p>Bridge priority is used in determining the root switch, root port and designated port. The Switch with the highest priority (lowest numeric value) becomes the STP root switch. If all Switches have the same priority, the Switch with the lowest MAC address will then become the root switch. Select a value from the drop-down list box.</p> <p>The lower the numeric value you assign, the higher the priority for this bridge.</p> <p>Bridge Priority determines the root bridge, which in turn determines Hello Time, Max Age and Forwarding Delay.</p>
Hello Time	This is the time interval in seconds between BPDU (Bridge Protocol Data Units) configuration message generations by the root switch. The allowed range is 1 to 10 seconds.
Max Age	This is the maximum time (in seconds) the Switch can wait without receiving a BPDU before attempting to reconfigure. All Switch ports (except for designated ports) should receive BPDUs at regular intervals. Any port that ages out STP information (provided in the last BPDU) becomes the designated port for the attached LAN. If it is a root port, a new root port is selected from among the Switch ports attached to the network. The allowed range is 6 to 40 seconds.

Table 127 SWITCHING > Spanning Tree Protocol > RSTP (continued)

LABEL	DESCRIPTION
Forwarding Delay	<p>This is the maximum time (in seconds) the Switch will wait before changing states. This delay is required because every Switch must receive information about topology changes before it starts to forward frames. In addition, each port needs time to listen for conflicting information that would make it return to a blocking state; otherwise, temporary data loops might result. The allowed range is 4 to 30 seconds.</p> <p>As a general rule:</p> $2 * (\text{Forward Delay} - 1) \geq \text{Max Age} \geq 2 * (\text{Hello Time} + 1)$
Port	This field displays the port number.
*	<p>Settings in this row apply to all ports.</p> <p>Use this row only if you want to make some settings the same for all ports. Use this row first to set the common settings and then make adjustments on a port-by-port basis.</p> <p>Note: Changes in this row are copied to all the ports as soon as you make them.</p>
Active	Select this checkbox to activate RSTP on this port.
Edge	<p>Select this checkbox to configure a port as an edge port when it is directly attached to a computer. An edge port changes its initial STP port state from blocking state to forwarding state immediately without going through listening and learning states right after the port is configured as an edge port or when its link status changes.</p> <p>Note: An edge port becomes a non-edge port as soon as it receives a Bridge Protocol Data Unit (BPDU).</p>
Priority	<p>Configure the priority for each port here.</p> <p>Priority decides which port should be disabled when more than one port forms a loop in a switch. Ports with a higher priority numeric value are disabled first. The allowed range is between 0 and 255 and the default value is 128.</p>
Path Cost	Path cost is the cost of transmitting a frame on to a LAN through that port. It is recommended to assign this value according to the speed of the bridge. The slower the media, the higher the cost.
Apply	Click Apply to save your changes to the Switch's run-time memory. The Switch loses these changes if it is turned off or loses power, so use the Save link on the top navigation panel to save your changes to the non-volatile memory when you are done configuring.
Cancel	Click Cancel to begin configuring this screen afresh.

CHAPTER 46

Static MAC Filtering

46.1 Static MAC Filtering Overview

This chapter discusses MAC address port filtering.

Filtering means sifting traffic going through the Switch based on the source and/or destination MAC addresses and VLAN group (ID).

46.1.1 What You Can Do

Use the **Static MAC Filtering** screen ([Section 46.2 on page 252](#)) to create rules for traffic going through the Switch.

46.2 Configure a Static MAC Filtering Rule

Use this screen to view and configure rules for traffic going through the Switch. Click **SWITCHING > Static MAC Filtering** in the navigation panel to display the screen as shown next.

Figure 181 SWITCHING > Static MAC Filtering

The following table describes the related labels in this screen.

Table 128 SWITCHING > Static MAC Filtering

LABEL	DESCRIPTION
Index	This field displays the index number of the rule.
Active	This field displays whether the rule is activated or not.
Name	This field displays the descriptive name for this rule. This is for identification purpose only.
MAC Address	This field displays the source or destination MAC address with the VLAN identification number to which the MAC address belongs.
VID	This field displays the VLAN group identification number.
Action	This field displays Discard source , Discard destination , or Discard both depending on what you configured above.
	Select an entry's checkbox to select a specific entry. Otherwise, select the checkbox in the table heading row to select all entries.

Table 128 SWITCHING > Static MAC Filtering (continued)

LABEL	DESCRIPTION
Add/Edit	Click Add/Edit to add a new entry or edit a selected one.
Delete	Click Delete to remove the selected entries.

46.2.1 Add/Edit a Static MAC Filtering Rule

Use this screen to create or edit rules for traffic going through the Switch. Click **Add/Edit**, or select an entry and click **Add/Edit** in the **SWITCHING > Static MAC Filtering** screen to display this screen.

Figure 182 SWITCHING > Static MAC Filtering > Add/Edit

The following table describes the related labels in this screen.

Table 129 SWITCHING > Static MAC Filtering > Add/Edit

LABEL	DESCRIPTION
Active	Enable the switch button to activate your rule. You may temporarily deactivate a rule without deleting it by de-selecting this checkbox.
Name	Enter a descriptive name (up to 32 printable ASCII characters excluding [?], [], ['], ["] or [,]) for this rule. This is for identification only.
Action	Select Discard source to drop the frames from the source MAC address (specified in the MAC field). The Switch can still send frames to the MAC address. Select Discard destination to drop the frames to the destination MAC address (specified in the MAC address). The Switch can still receive frames originating from the MAC address. Select Discard source and Discard destination to block traffic to or from the MAC address specified in the MAC field.
MAC	Enter a MAC address in valid MAC address format, that is, six hexadecimal character pairs.
VID	Enter the VLAN group identification number.
Apply	Click Apply to save your changes to the Switch's run-time memory. The Switch loses these changes if it is turned off or loses power, so use the Save link on the top navigation panel to save your changes to the non-volatile memory when you are done configuring.
Clear	Click Clear to clear the fields to the factory defaults.
Cancel	Click Cancel to not save the configuration you make and return to the last screen.

CHAPTER 47

Static MAC Forwarding

47.1 Static MAC Forwarding Overview

This chapter discusses how to configure forwarding rules based on MAC addresses of devices on your network.

Use these screens to configure static MAC address forwarding.

47.1.1 What You Can Do

Use the **Static MAC Forwarding** screen ([Section 47.2 on page 254](#)) to assign static MAC addresses for a port.

47.2 Configure Static MAC Forwarding

A static MAC address is an address that has been manually entered in the MAC address table. Static MAC addresses do not age out. When you set up static MAC address rules, you are setting static MAC addresses for a port. This may reduce the need for broadcasting.

Static MAC address forwarding together with port security allow only computers in the MAC address table on a port to access the Switch.

Click **SWITCHING > Static MAC Forwarding** in the navigation panel to display the configuration screen as shown.

Figure 183 SWITCHING > Static MAC Forwarding

<input type="checkbox"/>	Index	Active	Name	MAC Address	VID	Port
<input type="checkbox"/>	1	ON	Example	88:ac:88:ac:88:ac	1	17

The following table describes the labels in this screen.

Table 130 SWITCHING > Static MAC Forwarding

LABEL	DESCRIPTION
Index	This is the index number of a static MAC address rule.
Active	This field displays whether this static MAC address forwarding rule is active. You may temporarily deactivate a rule without deleting it.
Name	This field displays the descriptive name for identification purposes for this static MAC address-forwarding rule.
MAC Address	This field displays the MAC address that will be forwarded and the VLAN identification number to which the MAC address belongs.
VID	This field displays the ID number of the VLAN group.
Port	This field displays the port where the MAC address shown in the next field will be forwarded.
	Select an entry's checkbox to select a specific entry. Otherwise, select the checkbox in the table heading row to select all entries.
Add/Edit	Click Add/Edit to add a new rule or edit a selected one.
Delete	Click Delete to remove the selected rules.

47.2.1 Add/Edit Static MAC Forwarding Rules

Click **Add/Edit**, or select an entry and click **Add/Edit** in the **SWITCHING > Static MAC Forwarding** screen to display this screen.

Figure 184 SWITCHING > Static MAC Forwarding > Add/Edit

The following table describes the labels in this screen.

Table 131 SWITCHING > Static MAC Forwarding > Add/Edit

LABEL	DESCRIPTION
Active	Enable the switch button to activate your rule. You may temporarily deactivate a rule without deleting it by disabling the switch.
Name	Enter a descriptive name for identification purposes for this static MAC address forwarding rule. You can enter up to 32 printable ASCII characters except [?], [], ['], ["] or [,].
MAC Address	Enter the MAC address in valid MAC address format, that is, six hexadecimal character pairs. Note: Static MAC addresses do NOT age out.
VID	Enter the VLAN identification number.

Table 131 SWITCHING > Static MAC Forwarding > Add/Edit (continued)

LABEL	DESCRIPTION
Port	Enter the port where the MAC address entered in the previous field will be automatically forwarded.
Apply	Click Apply to save your changes to the Switch's run-time memory. The Switch loses these changes if it is turned off or loses power, so use the Save link on the top navigation panel to save your changes to the non-volatile memory when you are done configuring.
Clear	Click Clear to clear the fields to the factory defaults.
Cancel	Click Cancel to not save the configuration you make and return to the last screen.

CHAPTER 48

VLAN

48.1 VLAN Overview

This chapter shows you how to configure 802.1Q tagged and port-based VLANs.

The type of screen you see here depends on the **VLAN Type** you selected in the **SYSTEM > Switch Setup** screen.

48.1.1 What You Can Do

- Use the **VLAN Status** screen ([Section 48.3 on page 260](#)) to view and search all static VLAN groups.
- Use the **VLAN Status Details** screen ([Section 48.3.1 on page 261](#)) to view detailed port settings and status of the static VLAN group.
- Use the **Static VLAN Setup** screen ([Section 48.4 on page 262](#)) to configure a static VLAN for the Switch.
- Use the **VLAN Port Setup** screen ([Section 48.5 on page 264](#)) to configure the static VLAN (IEEE 802.1Q) settings on a port.
- Use the **Voice VLAN Setup** screen ([Section 48.6 on page 266](#)) to set up VLANs that allow you to group voice traffic with defined priority and enable the Switch port to carry the voice traffic separately from data traffic to ensure the sound quality does NOT deteriorate.
- Use the **MAC Based VLAN Setup** screen ([Section 48.7 on page 268](#)) to set up VLANs that allow you to group untagged packets into logical VLANs based on the source MAC address of the packet. This eliminates the need to reconfigure the Switch when you change ports. The Switch will forward the packets based on the source MAC address you set up previously.
- Use the **Vendor ID Based VLAN Setup** screen ([Section 48.8 on page 269](#)) to set up VLANs that allow you to group untagged packets into logical VLANs based on the source MAC address of the packet. You can specify a mask for the MAC address to create a MAC address filter and enter a weight to set the VLAN rule's priority.
- Use the **Port-Based VLAN Setup** screen ([Section 48.9 on page 271](#)) to set up VLANs where the packet forwarding decision is based on the destination MAC address and its associated port.

48.1.2 What You Need to Know

Read this section to know more about VLAN and how to configure the screens.

48.2 Introduction to IEEE 802.1Q Tagged VLANs

A tagged VLAN uses an explicit tag (VLAN ID) in the MAC header to identify the VLAN membership of a frame across bridges – they are not confined to the switch on which they were created. The VLANs can be created statically by hand. The VLAN ID associates a frame with a specific VLAN and provides the information that switches need to process the frame across the network. A tagged frame is 4 bytes longer than an untagged frame and contains 2 bytes (16 Bits) of TPID (Tag Protocol Identifier, residing

within the type or length field of the Ethernet frame) and 2 bytes (16 Bits) of TCI (Tag Control Information, starts after the source address field of the Ethernet frame). The TCI field consists of three fields: User Priority, CFI (Canonical Format Indicator), and VLAN ID.

The CFI (Canonical Format Indicator) is a single-bit flag, always set to zero for Ethernet switches. If a frame received at an Ethernet port has a CFI set to 1, then that frame should not be forwarded as it is to an untagged port. The remaining twelve bits define the VLAN ID, giving a possible maximum number of 4096 VLANs. Note that user priority and VLAN ID are independent of each other. A frame with VID (VLAN Identifier) of null (0) is called a priority frame, meaning that only the priority level is significant and the default VID of the ingress port is given as the VID of the frame. Of the 4096 possible VIDs, a VID of 0 is used to identify priority frames and value 4095 (FFF) is reserved, so the maximum possible VLAN configurations are 4094.

TPID	User Priority	CFI	VLAN ID
16 Bits	3 Bits	1 Bit	12 Bits

Forwarding Tagged and Untagged Frames

Each port on the Switch is capable of passing tagged or untagged frames. To forward a frame from an 802.1Q VLAN-aware switch to an 802.1Q VLAN-unaware switch, the Switch first decides where to forward the frame and then strips off the VLAN tag. To forward a frame from an 802.1Q VLAN-unaware switch to an 802.1Q VLAN-aware switch, the Switch first decides where to forward the frame, and then inserts a VLAN tag reflecting the ingress port's default VID. The default PVID is VLAN 1 for all ports, but this can be changed.

A broadcast frame (or a multicast frame for a multicast group that is known by the system) is duplicated only on ports that are members of the VID (except the ingress port itself), thus confining the broadcast to a specific domain.

48.2.0.1 Port VLAN Trunking

Enable **VLAN Trunking** on a port to allow frames belonging to unknown VLAN groups to pass through that port. This is useful if you want to set up VLAN groups on end devices without having to configure the same VLAN groups on intermediary devices.

Refer to the following figure. Suppose you want to create VLAN groups 1 and 2 (V1 and V2) on devices A and B. Without **VLAN Trunking**, you must configure VLAN groups 1 and 2 on all intermediary switches C, D and E; otherwise they will drop frames with unknown VLAN group tags. However, with **VLAN Trunking** enabled on ports in each intermediary switch you only need to create VLAN groups in the end devices (A and B). C, D and E automatically allow frames with VLAN group tags 1 and 2 (VLAN groups that are unknown to those switches) to pass through their VLAN trunking ports.

Figure 185 Port VLAN Trunking

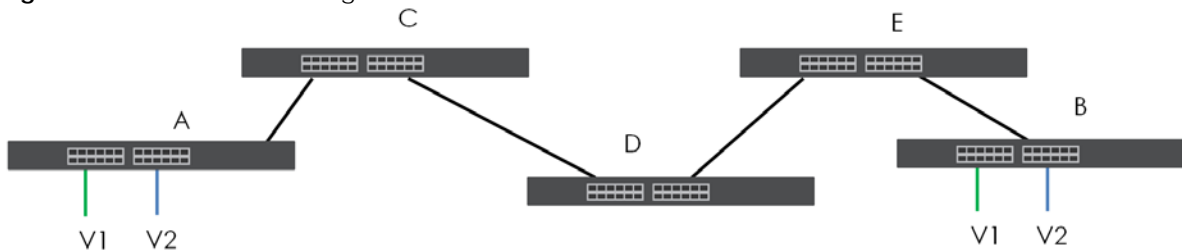

48.2.0.2 VLAN Priority

At the time of writing, you can create static VLANs, Voice VLANs, MAC-based VLANs and Vendor ID-based VLANs on the Switch when the VLAN type is set to **802.1Q**. When a packet is received, the Switch processes the VLAN rules in sequence. The sequence (priority) of the VLANs is:

- 1 Vendor ID Based VLAN
- 2 Voice VLAN
- 3 MAC Based VLAN

If the packet matches a VLAN rule that has a higher priority, for example, an entry with weight 250 in the vendor ID to VLAN mapping table, the Switch assigns the corresponding VLAN ID to the packet and stops checking the subsequent VLAN rules.

48.2.0.3 Select the VLAN Type

Select a VLAN type in the **SYSTEM > Switch Setup** screen.

Figure 186 SYSTEM > Switch Setup: Select VLAN Type

The screenshot shows the 'Switch Setup' configuration page. At the top, there is a 'VLAN Type' section with two radio buttons: '802.1Q' (which is selected) and 'Port Based'. Below this, there are two sections for 'MAC Address Learning' and 'ARP Aging Time', each with an 'Aging Time' input field set to '300' seconds. At the bottom, there are 'Apply' and 'Cancel' buttons.

802.1Q Static VLAN

Make sure **802.1Q** is selected in the **SYSTEM > Switch Setup** screen.

Use a static VLAN to decide whether an incoming frame on a port should be

- sent to a VLAN group as normal depending on its VLAN tag.
- sent to a group whether it has a VLAN tag or not.
- blocked from a VLAN group regardless of its VLAN tag.

You can also tag all outgoing frames (that were previously untagged) from a port with the specified VID.

48.2.0.4 Automatic VLAN Registration

GARP and GVRP are the protocols used to automatically register VLAN membership across switches.

GARP

GARP (Generic Attribute Registration Protocol) allows network switches to register and de-register attribute values with other GARP participants within a bridged LAN. GARP is a protocol that provides a generic mechanism for protocols that serve a more specific application, for example, GVRP.

GARP Timers

Switches join VLANs by making a declaration. A declaration is made by issuing a Join message using GARP. Declarations are withdrawn by issuing a Leave message. A Leave All message terminates all registrations. GARP timers set declaration timeout values.

GVRP

GVRP (GARP VLAN Registration Protocol) is a registration protocol that defines a way for switches to register necessary VLAN members on ports across the network. Enable this function to permit VLAN groups beyond the local Switch.

Please refer to the following table for common IEEE 802.1Q VLAN terminology.

Table 132 IEEE 802.1Q VLAN Terminology

VLAN PARAMETER	TERM	DESCRIPTION
VLAN Type	Permanent VLAN	This is a static VLAN created manually.
	Dynamic VLAN	This is a VLAN configured by a GVRP registration or de-registration process.
VLAN Administrative Control	Registration Fixed	Fixed registration ports are permanent VLAN members.
	Registration Forbidden	Ports with registration forbidden are forbidden to join the specified VLAN.
	Normal Registration	Ports dynamically join a VLAN using GVRP.
VLAN Tag Control	Tagged	Ports belonging to the specified VLAN tag all outgoing frames transmitted.
	Untagged	Ports belonging to the specified VLAN do not tag all outgoing frames transmitted.
VLAN Port	Port VID	This is the VLAN ID assigned to untagged frames that this port received.
	Acceptable Frame Type	You may choose to accept both tagged and untagged incoming frames, just tagged incoming frames or just untagged incoming frames on a port.
	Ingress filtering	If set, the Switch discards incoming frames for VLANs that do not have this port as a member.

48.3 VLAN Status

Use this screen to view and search all static VLAN groups. Click **SWITCHING > VLAN > VLAN Status** from the navigation panel to display the screen as shown next.

Figure 187 SWITCHING > VLAN > VLAN Status

Index	VID	Name	Tagged Port	Untagged Port	Elapsed Time	Status
1	1	1		1-54	7:59:18	Static
2	100	VLAN100			0:00:05	Static

The following table describes the labels in this screen.

Table 133 SWITCHING > VLAN > VLAN Status

LABEL	DESCRIPTION
VLAN Search by VID	Enter (an) existing VLAN ID numbers (use a comma (,) to separate individual VLANs or a hyphen (-) to indicate a range of VLANs. For example, "3,4" or "3-9") and click Search to display only the specified VLANs in the list below. Leave this field blank and click Search to display all VLANs configured on the Switch.
The Number of VLAN	This is the number of VLANs configured on the Switch.
The Number of Search Results	This is the number of VLANs that match the searching criteria and display in the list below. This field displays only when you use the Search button to look for certain VLANs.
Index	This is the VLAN index number. Click an index number to view more VLAN details.
VID	This is the VLAN identification number that was configured in the corresponding VLAN configuration screen.
Name	This fields shows the descriptive name of the VLAN.
Tagged Port	This field shows the tagged ports that are participating in the VLAN.
Untagged Port	This field shows the untagged ports that are participating in the VLAN.
Elapsed Time	This field shows how long it has been since a normal VLAN was registered or a static VLAN was set up.
Status	This field shows how this VLAN was added to the Switch. Static: added as a permanent entry.

48.3.1 VLAN Details

Use this screen to view detailed port settings and status of the static VLAN group. Click an index number in the **VLAN Status** screen to display VLAN details.

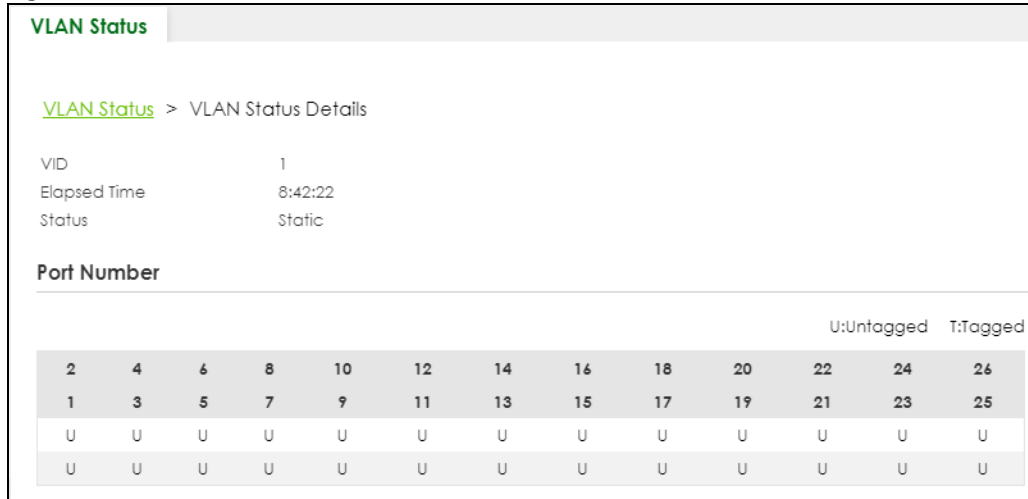
Figure 188 SWITCHING > VLAN > VLAN Status > VLAN Status Details

VLAN Status

VLAN Status > VLAN Status Details

VID: 1
Elapsed Time: 8:42:22
Status: Static

Port Number

												U:Untagged	T:Tagged	
2	4	6	8	10	12	14	16	18	20	22	24	26		
1	3	5	7	9	11	13	15	17	19	21	23	25		
U	U	U	U	U	U	U	U	U	U	U	U	U		
U	U	U	U	U	U	U	U	U	U	U	U	U		

The following table describes the labels in this screen.

Table 134 SWITCHING > VLAN > VLAN Status > VLAN Status Details

LABEL	DESCRIPTION
VID	This is the VLAN identification number that was configured in the corresponding VLAN configuration screen.
Elapsed Time	This field shows how long it has been since a normal VLAN was registered or a static VLAN was set up.
Status	This field shows how this VLAN was added to the Switch. Static: added as a permanent entry.
Port Number	This section displays the ports that are participating in a VLAN. A tagged port is marked as T, an untagged port is marked as U and ports not participating in a VLAN are marked as “-”.

48.4 Configure a Static VLAN

Use this screen to view and configure a static VLAN for the Switch. Click **SWITCHING > VLAN > VLAN Setup > Static VLAN** to display the screen as shown next.

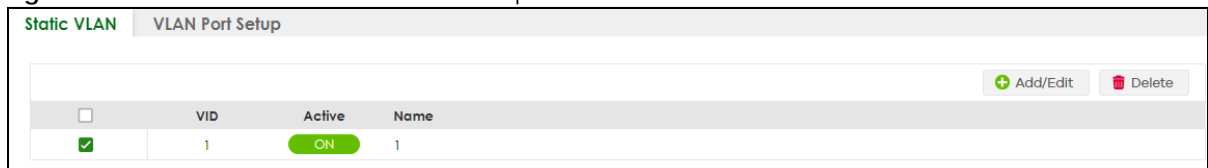
Figure 189 SWITCHING > VLAN > VLAN Setup > Static VLAN

Static VLAN VLAN Port Setup

+ Add/Edit Delete

<input type="checkbox"/>	VID	Active	Name
<input checked="" type="checkbox"/>	1	ON	1

The following table describes the related labels in this screen.

Table 135 SWITCHING > VLAN > VLAN Setup > Static VLAN

LABEL	DESCRIPTION
VID	This field displays the ID number of the VLAN group.
Active	This field indicates whether the VLAN settings are enabled or disabled.
Name	This field displays the descriptive name for this VLAN group.

Table 135 SWITCHING > VLAN > VLAN Setup > Static VLAN (continued)

LABEL	DESCRIPTION
	Select an entry's checkbox to select a specific entry. Otherwise, select the checkbox in the table heading row to select all entries.
Add/Edit	Click Add/Edit to add a new static VLAN or edit a selected one.
Delete	Click Delete to remove the selected static VLAN.

48.4.1 Add/Edit a Static VLAN

Use this screen to configure a static VLAN for the Switch. Click **Add/Edit**, or select an entry and click **Add/Edit** in the **SWITCHING > VLAN > VLAN Setup > Static VLAN** screen to display this screen.

Figure 190 SWITCHING > VLAN > VLAN Setup > Static VLAN > Add/Edit

Active ON

Name

VLAN Group ID

Port	Control	Tagging
*	Normal <input type="checkbox"/> Fixed <input type="checkbox"/> Forbidden <input type="checkbox"/>	<input checked="" type="checkbox"/> Tx Tagging
1	<input checked="" type="radio"/> Normal <input type="radio"/> Fixed <input type="radio"/> Forbidden	<input checked="" type="checkbox"/> Tx Tagging
2	<input checked="" type="radio"/> Normal <input type="radio"/> Fixed <input type="radio"/> Forbidden	<input checked="" type="checkbox"/> Tx Tagging
3	<input checked="" type="radio"/> Normal <input type="radio"/> Fixed <input type="radio"/> Forbidden	<input checked="" type="checkbox"/> Tx Tagging
4	<input checked="" type="radio"/> Normal <input type="radio"/> Fixed <input type="radio"/> Forbidden	<input checked="" type="checkbox"/> Tx Tagging
5	<input checked="" type="radio"/> Normal <input type="radio"/> Fixed <input type="radio"/> Forbidden	<input checked="" type="checkbox"/> Tx Tagging
6	<input checked="" type="radio"/> Normal <input type="radio"/> Fixed <input type="radio"/> Forbidden	<input checked="" type="checkbox"/> Tx Tagging
7	<input checked="" type="radio"/> Normal <input type="radio"/> Fixed <input type="radio"/> Forbidden	<input checked="" type="checkbox"/> Tx Tagging
8	<input checked="" type="radio"/> Normal <input type="radio"/> Fixed <input type="radio"/> Forbidden	<input checked="" type="checkbox"/> Tx Tagging
9	<input checked="" type="radio"/> Normal <input type="radio"/> Fixed <input type="radio"/> Forbidden	<input checked="" type="checkbox"/> Tx Tagging

Apply Clear Cancel

The following table describes the related labels in this screen.

Table 136 SWITCHING > VLAN > VLAN Setup > Static VLAN > Add/Edit

LABEL	DESCRIPTION
Active	Enable the switch button to activate the VLAN settings.
Name	Enter a descriptive name for the VLAN group for identification purposes. This name consists of up to 64 printable ASCII characters. The string should not contain [?], [], ['], ["] or [,].
VLAN Group ID	Enter the VLAN ID for this static entry; the valid range is between 1 and 4094. Note: Do NOT add a VLAN ID that has been used in the SWITCHING > VLAN > Voice VLAN Setup .
Port	The port number identifies the port you are configuring.

Table 136 SWITCHING > VLAN > VLAN Setup > Static VLAN > Add/Edit (continued)

LABEL	DESCRIPTION
*	<p>Settings in this row apply to all ports.</p> <p>Use this row only if you want to make some settings the same for all ports. Use this row first to set the common settings and then make adjustments on a port-by-port basis.</p> <p>Note: Changes in this row are copied to all the ports as soon as you make them.</p>
Control	<p>Select Normal for the port to dynamically join this VLAN group. This is the default selection.</p> <p>Select Fixed for the port to be a permanent member of this VLAN group.</p> <p>Select Forbidden if you want to prohibit the port from joining this VLAN group.</p>
Tagging	<p>Select Tx Tagging if you want outgoing traffic to contain this VLAN tag.</p> <p>Otherwise, to ensure that VLAN-unaware devices (such as computers and hubs) can receive frames properly, clear the Tx Tagging checkbox to set the Switch to remove VLAN tags before sending.</p>
Apply	<p>Click Apply to save your changes to the Switch's run-time memory. The Switch loses these changes if it is turned off or loses power, so use the Save link on the top navigation panel to save your changes to the non-volatile memory when you are done configuring.</p>
Clear	<p>Click Clear to clear the fields to the factory defaults.</p>
Cancel	<p>Click Cancel to not save the configuration you make and return to the last screen.</p>

48.5 VLAN Port Setup

Use this screen to configure the static VLAN (IEEE 802.1Q) settings on a port. Click **SWITCHING > VLAN > VLAN Setup > VLAN Port Setup** to display the screen as shown.

Figure 191 SWITCHING > VLAN > VLAN Setup > VLAN Port Setup

Static VLAN		VLAN Port Setup			
Port	Ingress Check	PVID	Acceptable Frame Type	VLAN Trunking	Isolation
*	<input type="checkbox"/>	<input type="text"/>	All	<input type="checkbox"/>	<input type="checkbox"/>
1	<input type="checkbox"/>	1	All	<input type="checkbox"/>	<input type="checkbox"/>
2	<input type="checkbox"/>	1	All	<input type="checkbox"/>	<input type="checkbox"/>
3	<input type="checkbox"/>	1	All	<input type="checkbox"/>	<input type="checkbox"/>
4	<input type="checkbox"/>	1	All	<input type="checkbox"/>	<input type="checkbox"/>
5	<input type="checkbox"/>	1	All	<input type="checkbox"/>	<input type="checkbox"/>
6	<input type="checkbox"/>	1	All	<input type="checkbox"/>	<input type="checkbox"/>
7	<input type="checkbox"/>	1	All	<input type="checkbox"/>	<input type="checkbox"/>
8	<input type="checkbox"/>	1	All	<input type="checkbox"/>	<input type="checkbox"/>
9	<input type="checkbox"/>	1	All	<input type="checkbox"/>	<input type="checkbox"/>
10	<input type="checkbox"/>	1	All	<input type="checkbox"/>	<input type="checkbox"/>
11	<input type="checkbox"/>	1	All	<input type="checkbox"/>	<input type="checkbox"/>
12	<input type="checkbox"/>	1	All	<input type="checkbox"/>	<input type="checkbox"/>
13	<input type="checkbox"/>	1	All	<input type="checkbox"/>	<input type="checkbox"/>
14	<input type="checkbox"/>	1	All	<input type="checkbox"/>	<input type="checkbox"/>
15	<input type="checkbox"/>	1	All	<input type="checkbox"/>	<input type="checkbox"/>
16	<input type="checkbox"/>	1	All	<input type="checkbox"/>	<input type="checkbox"/>
17	<input type="checkbox"/>	1	All	<input type="checkbox"/>	<input type="checkbox"/>

The following table describes the labels in this screen.

Table 137 SWITCHING > VLAN > VLAN Setup > VLAN Port Setup

LABEL	DESCRIPTION
Port	This field displays the port number.
*	<p>Settings in this row apply to all ports.</p> <p>Use this row only if you want to make some settings the same for all ports. Use this row first to set the common settings and then make adjustments on a port-by-port basis.</p> <p>Note: Changes in this row are copied to all the ports as soon as you make them.</p>
Ingress Check	<p>If this checkbox is selected, the Switch discards incoming frames on a port for VLANs that do not include this port in its member set.</p> <p>Clear this checkbox to disable ingress filtering.</p>
PVID	<p>A PVID (Port VLAN ID) is a tag that adds to incoming untagged frames received on a port so that the frames are forwarded to the VLAN group that the tag defines.</p> <p>Enter a number between 1 and 4094 as the port VLAN ID.</p>
Acceptable Frame Type	<p>Specify the type of frames allowed on a port. Choices are All, Tag Only and Untag Only.</p> <p>Select All from the drop-down list box to accept all untagged or tagged frames on this port. This is the default setting.</p> <p>Select Tag Only to accept only tagged frames on this port. All untagged frames will be dropped.</p> <p>Select Untag Only to accept only untagged frames on this port. All tagged frames will be dropped.</p>

Table 137 SWITCHING > VLAN > VLAN Setup > VLAN Port Setup (continued)

LABEL	DESCRIPTION
VLAN Trunking	Enable VLAN Trunking on ports connected to other switches or routers (but not ports directly connected to end users) to allow frames belonging to unknown VLAN groups to pass through the Switch.
Isolation	Select this to allows this port to communicate only with the CPU management port and the ports on which the isolation feature is NOT enabled.
Apply	Click Apply to save your changes to the Switch's run-time memory. The Switch loses these changes if it is turned off or loses power, so use the Save link on the top navigation panel to save your changes to the non-volatile memory when you are done configuring.
Cancel	Click Cancel to begin configuring this screen afresh.

48.6 Voice VLAN

Voice VLAN is a VLAN that is specifically allocated for voice traffic. It ensures that the sound quality of an IP phone is preserved from deteriorating when the data traffic on the Switch ports is high. It groups the voice traffic with defined priority into an assigned VLAN which enables the separation of voice and data traffic coming onto the Switch port.

The Switch can determine whether a received packet is

- an untagged voice packet when the incoming port is a fixed port for voice VLAN.
- a tagged voice packet when the incoming port and VLAN tag belongs to a voice VLAN.

It then checks the source packet's MAC address against an OUI list. If a match is found, the packet is considered as a voice packet.

You can set priority level to the Voice VLAN and add MAC address of IP phones from specific manufacturers by using its ID from the Organizationally Unique Identifiers (OUI).

Click **SWITCHING > VLAN > Voice VLAN Setup** to display the configuration screen as shown.

Figure 192 SWITCHING > VLAN > Voice VLAN Setup

Voice VLAN Setup

Voice VLAN Global Setup

Voice VLAN Disable

Priority

Apply **Cancel**

Voice VLAN OUI Setup

Index	OUI Address	OUI Mask	Description
<input type="checkbox"/>			

The following table describes the fields in the above screen.

Table 138 SWITCHING > VLAN > Voice VLAN Setup

LABEL	DESCRIPTION
Voice VLAN Global Setup	
Voice VLAN	Click the second radio button if you want to enable the Voice VLAN feature. Enter a VLAN ID number that is associated with the Voice VLAN. Click the Disable radio button if you do not want to enable the Voice VLAN feature.
Priority	Select the priority level of the voice traffic from 0 to 7. Default setting is 5. The higher the numeric value you assign, the higher the priority for this voice traffic.
Apply	Click Apply to save your changes to the Switch's run-time memory. The Switch loses these changes if it is turned off or loses power, so use the Save link on the top navigation panel to save your changes to the non-volatile memory when you are done configuring.
Cancel	Click Cancel to begin configuring this section afresh.
Voice VLAN OUI Setup	
Index	This field displays the index number of the Voice VLAN.
OUI Address	This field displays the OUI address of the Voice VLAN.
OUI Mask	This field displays the OUI mask address of the Voice VLAN.
Description	This field displays the description of the Voice VLAN with OUI address.
	Select an entry's checkbox to select a specific entry. Otherwise, select the checkbox in the table heading row to select all entries.
Add/Edit	Click Add/Edit to add a new entry or edit a selected one.
Delete	Click Delete to remove the selected entry.

48.6.1 Add/Edit a Voice VLAN

Click **Add/Edit**, or select an entry and click **Add/Edit** in the **SWITCHING > VLAN > Voice VLAN Setup** screen to display the configuration screen.

Figure 193 SWITCHING > VLAN > Voice VLAN Setup > Add/Edit

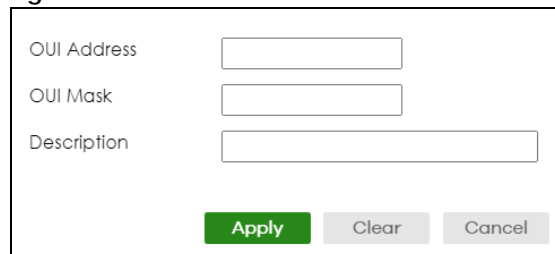

OUI Address

OUI Mask

Description

Apply Clear Cancel

The following table describes the fields in the above screen.

Table 139 SWITCHING > VLAN > Voice VLAN Setup > Add/Edit

LABEL	DESCRIPTION
OUI Address	Enter the IP phone manufacturer's OUI MAC address. The first 3 bytes is the manufacturer identifier, the last 3 bytes is a unique station ID.
OUI Mask	Enter the mask for the specified IP phone manufacturer's OUI MAC address to determine which bits a packet's MAC address should match. Enter "f" for each bit of the specified MAC address that the traffic's MAC address should match. Enter "0" for the bits of the matched traffic's MAC address, which can be of any hexadecimal characters. For example, if you set the MAC address to 00:13:49:00:00:00 and the mask to ff:ff:ff:00:00:00, a packet with a MAC address of 00:13:49:12:34:56 matches this criteria.
Description	Enter a description up to 32 printable ASCII characters except [?], [], ['], or ["] for the Voice VLAN device. For example: Siemens.
Apply	Click Apply to save your changes to the Switch's run-time memory. The Switch loses these changes if it is turned off or loses power, so use the Save link on the top navigation panel to save your changes to the non-volatile memory when you are done configuring.
Clear	Click Clear to clear the fields to the factory defaults.
Cancel	Click Cancel to not save the configuration you make and return to the last screen.

48.7 MAC Based VLAN

The MAC-based VLAN feature assigns incoming untagged packets to a VLAN and classifies the traffic based on the source MAC address of the packet. When untagged packets arrive at the Switch, the source MAC address of the packet is looked up in a MAC to VLAN mapping table. If an entry is found, the corresponding VLAN ID is assigned to the packet. The assigned VLAN ID is verified against the VLAN table. If the VLAN is valid, ingress processing on the packet continues; otherwise, the packet is dropped.

This feature allows users to change ports without having to reconfigure the VLAN. You can assign priority to the MAC-based VLAN and define a MAC to VLAN mapping table by entering a specified source MAC address in the MAC-based VLAN setup screen. You can also delete a MAC-based VLAN entry in the same screen.

Click **SWITCHING > VLAN > MAC Based VLAN Setup** to see the following screen.

Figure 194 SWITCHING > VLAN > MAC Based VLAN Setup

The following table describes the fields in the above screen.

Table 140 SWITCHING > VLAN > MAC Based VLAN Setup

LABEL	DESCRIPTION
Index	This field displays the index number of the MAC-based VLAN entry.
Name	This field displays the name of the MAC-based VLAN entry.
MAC Address	This field displays the source MAC address that is bind to the MAC-based VLAN entry.
VID	This field displays the VLAN ID of the MAC-based VLAN entry.

Table 140 SWITCHING > VLAN > MAC Based VLAN Setup (continued)

LABEL	DESCRIPTION
Priority	This field displays the priority level which is assigned to frames belonging to this MAC-based VLAN entity.
	Select an entry's checkbox to select a specific entry. Otherwise, select the checkbox in the table heading row to select all entries.
Add/Edit	Click Add/Edit to add a new entry or edit a selected one.
Delete	Click Delete to remove the selected entry.

48.7.1 Add/Edit a MAC Based VLAN

Click **Add/Edit**, or select an entry and click **Add/Edit** in the **SWITCHING > VLAN > MAC Based VLAN Setup** screen to see this screen.

Figure 195 SWITCHING > VLAN > MAC Based VLAN Setup > Add/Edit

The following table describes the fields in the above screen.

Table 141 SWITCHING > VLAN > MAC Based VLAN Setup > Add/Edit

LABEL	DESCRIPTION
Name	Enter a name up to 32 alphanumeric characters except [?], [], ['], ["] or [,] for the MAC-based VLAN entry.
MAC Address	Enter a MAC address that is bind to the MAC-based VLAN entry. This is the source MAC address of the data packet that is looked up when untagged packets arrive at the Switch.
VID	Enter an ID (from 1 to 4094) for the VLAN that is associated with the MAC-based VLAN entry.
Priority	Enter a priority (0 to 7) that the Switch assigns to frames belonging to this VLAN. The higher the numeric value you assign, the higher the priority for this MAC-based VLAN entry.
Apply	Click Apply to save your changes to the Switch's run-time memory. The Switch loses these changes if it is turned off or loses power, so use the Save link on the top navigation panel to save your changes to the non-volatile memory when you are done configuring.
Clear	Click Clear to clear the fields to the factory defaults.
Cancel	Click Cancel to not save the configuration you make and return to the last screen.

48.8 Vendor ID Based VLAN

The Vendor ID based VLAN feature assigns incoming untagged packets to a VLAN and classifies the traffic based on the source MAC address of the packet. When untagged packets arrive at the switch, the source MAC address of the packet is looked up in a Vendor ID to VLAN mapping table. If an entry is found, the corresponding VLAN ID is assigned to the packet. The assigned VLAN ID is verified against the

VLAN table. If the VLAN is valid, ingress processing on the packet continues; otherwise, the packet is dropped.

This feature allows users to change ports without having to reconfigure the VLAN. You can assign a 802.1p priority to the vendor ID based VLAN and define a vendor ID to VLAN mapping table by entering a specified source MAC address and mask in the vendor ID based VLAN setup screen. You can also delete a vendor ID based VLAN entry in the same screen.

For every vendor ID based VLAN rule you set, you can specify a weight number to define the rule's priority level. As rules are processed one after the other, stating a priority order will let you choose which rule has to be applied first and which second.

Click the **SWITCHING > VLAN > Vendor ID Based VLAN Setup** to see the following screen.

Figure 196 SWITCHING > VLAN > Vendor ID Based VLAN Setup

The following table describes the fields in the above screen.

Table 142 SWITCHING > VLAN > Vendor ID Based VLAN Setup

LABEL	DESCRIPTION
Index	This field displays the index number of the vendor ID based VLAN entry.
Name	This field displays the name of the vendor ID based VLAN entry.
MAC Address	This field displays the source MAC address that is bind to the vendor ID based VLAN entry.
Mask	This field displays the mask for the source MAC address that is bind to the vendor ID based VLAN entry.
VLAN	This field displays the VLAN ID of the vendor ID based VLAN entry.
Priority	This field displays the priority level which is assigned to frames belonging to this vendor ID based VLAN.
Weight	This field displays the weight of the vendor ID based VLAN entry.
	Select an entry's checkbox to select a specific entry. Otherwise, select the checkbox in the table heading row to select all entries.
Add/Edit	Click Add/Edit to add a new entry or edit a selected one.
Delete	Click Delete to remove the selected entry.

48.8.1 Add/Edit a Vendor ID Based VLAN

Click **Add/Edit**, or select an entry and click **Add/Edit** in the **SWITCHING > VLAN > Vendor ID Based VLAN Setup** to see this screen.

Figure 197 SWITCHING > VLAN > Vendor ID Based VLAN Setup > Add/Edit

Name	<input type="text"/>
MAC Address	<input type="text" value="5c:e2:8c:11:22:33"/>
Mask	<input type="text" value="ff:ff:ff:00:00:00"/>
VID	<input type="text"/>
Priority	<input type="text" value="0"/> ▼
Weight	<input type="text" value="127"/>
<input type="button" value="Apply"/> <input type="button" value="Clear"/> <input type="button" value="Cancel"/>	

The following table describes the fields in the above screen.

Table 143 SWITCHING > VLAN > Vendor ID Based VLAN Setup > Add/Edit

LABEL	DESCRIPTION
Name	Enter a name up to 32 alphanumeric characters except [?], [], ['], or ["] for the vendor ID based VLAN entry.
MAC Address	Enter a MAC address that is bind to the vendor ID-based VLAN entry. This is the source MAC address of the data packet that is looked up when untagged packets arrive at the Switch.
Mask	Enter the mask for the specified source MAC address to determine which bits a packet's MAC address should match. Enter "f" for each bit of the specified MAC address that the traffic's MAC address should match. Enter "0" for the bits of the matched traffic's MAC address, which can be of any hexadecimal characters. For example, if you set the MAC address to 00:13:49:00:00:00 and the mask to ff:ff:ff:00:00:00, a packet with a MAC address of 00:13:49:12:34:56 matches this criteria.
VID	Enter an ID (from 1 to 4094) for the VLAN that is associated with the vendor ID based VLAN entry.
Priority	Select the priority level that the Switch assigns to frames belonging to this VLAN. The higher the numeric value you assign, the higher the priority for this vendor ID based VLAN entry.
Weight	Enter a number between 0 and 255 to specify the rule's weight. This is to decide the priority in which the rule is applied. The higher the number, the higher the rule's priority.
Apply	Click Apply to save your changes to the Switch's run-time memory. The Switch loses these changes if it is turned off or loses power, so use the Save link on the top navigation panel to save your changes to the non-volatile memory when you are done configuring.
Clear	Click Clear to clear the fields to the factory defaults.
Cancel	Click Cancel to not save the configuration you make and return to the last screen.

48.9 Port-Based VLAN Setup

Port-based VLANs are VLANs where the packet forwarding decision is based on the destination MAC address and its associated port.

Port-based VLANs require allowed outgoing ports to be defined for each port. Therefore, if you wish to allow two subscriber ports to talk to each other, for example, between conference rooms in a hotel, you must define the egress (an egress port is an outgoing port, that is, a port through which a data packet leaves) for both ports.

Port-based VLANs are specific only to the Switch on which they were created.

Note: When you activate port-based VLAN, the Switch uses a default VLAN ID of 1. You cannot change it.

Note: In screens (such as **SYSTEM > IP Setup** and **SWITCHING > Static MAC Filtering**) that require a VID, you must enter 1 as the VID.

The port-based VLAN setup screen is shown next. The **CPU** management port forms a VLAN with all Ethernet ports.

48.10 Configure a Port-Based VLAN

Select **Port Based** as the VLAN Type in the **SYSTEM > Switch Setup** screen and then click **SWITCHING > VLAN** from the navigation panel to display the next screen.

Select either **All Connected** or **Port Isolated** from the drop-down list depending on your VLAN and VLAN security requirements. If VLAN members need to communicate directly with each other, then select **All Connected**. Select **Port Isolated** if you want to restrict users from communicating directly. Click **Apply** to save your settings.

The following screen shows users on a port-based, all-connected VLAN configuration.

Figure 198 SWITCHING > VLAN > Port Based VLAN Setup (All Connected)

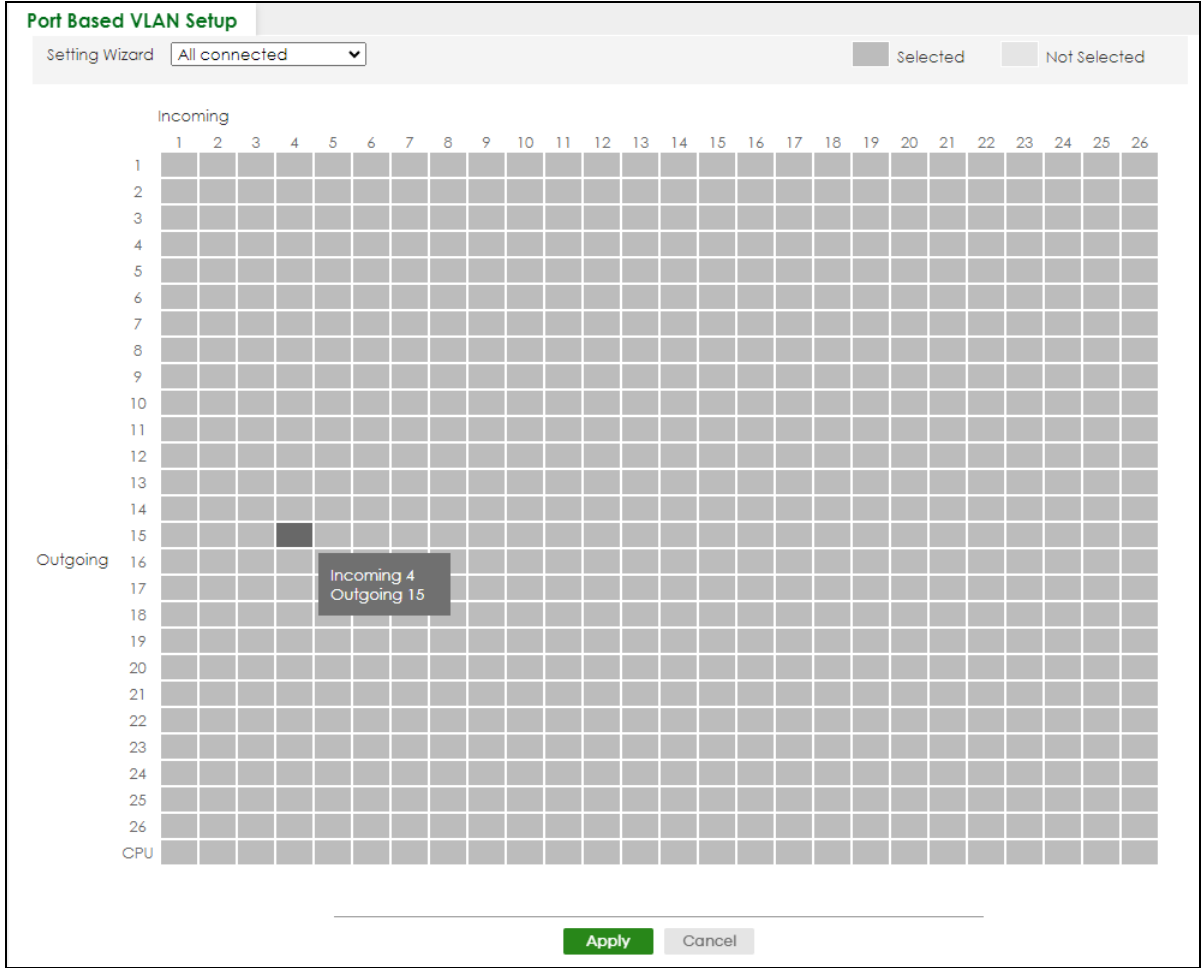

The following screen shows users on a port-based, port-isolated VLAN configuration.

Figure 199 SWITCHING > VLAN: Port Based VLAN Setup (Port Isolation)

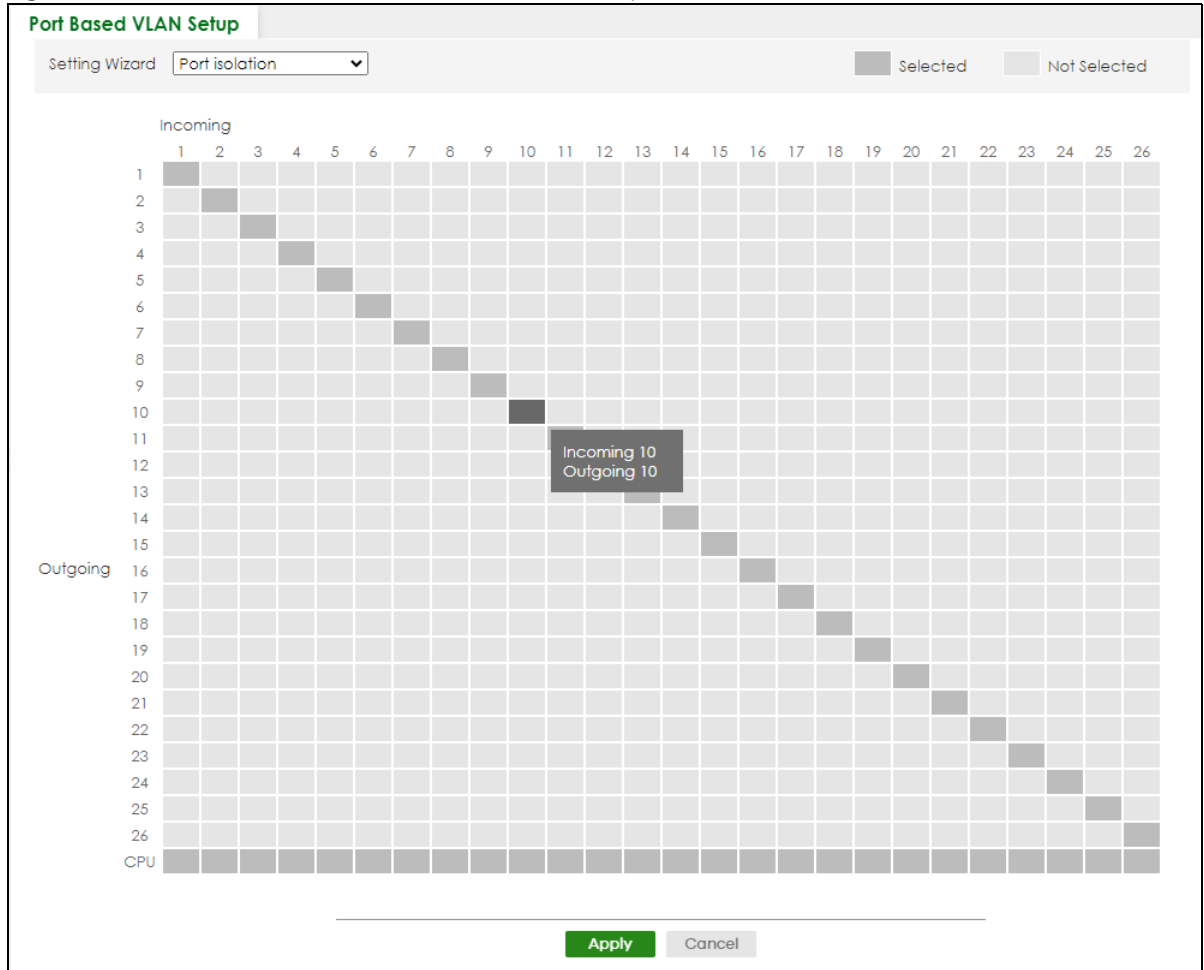

The following table describes the labels in this screen.

Table 144 SWITCHING > VLAN > Port Based VLAN Setup

LABEL	DESCRIPTION
Setting Wizard	<p>Choose Current configuration to display the Switch's current port-based VLAN configuration.</p> <p>Choose All connected or Port isolation wizard to quickly set up a port-based VLAN according to the below descriptions.</p> <p>All connected means all ports can communicate with each other, that is, there are no virtual LANs. All incoming and outgoing ports are selected. This option is the most flexible but also the least secure.</p> <p>Port isolation means that each port can only communicate with the CPU management port and cannot communicate with each other. All incoming ports are selected while only the CPU outgoing port is selected. This option is the most limiting but also the most secure.</p> <p>After selecting the setting wizard, you can customize the port settings. Click on the ports to add or delete incoming or outgoing ports. The configuration will be saved only after you click Apply at the bottom of the screen.</p>
Incoming	<p>These are the ingress ports; an ingress port is an incoming port, that is, a port through which a data packet enters. If you wish to allow two subscriber ports to talk to each other, you must define the ingress port for both ports. The numbers in the top row denote the incoming port for the corresponding port listed on the left (its outgoing port). CPU refers to the Switch management port. By default it forms a VLAN with all Ethernet ports. If it does not form a VLAN with a particular port then the Switch cannot be managed from that port.</p>
Outgoing	<p>These are the egress ports; an egress port is an outgoing port, that is, a port through which a data packet leaves. If you wish to allow two subscriber ports to talk to each other, you must define the egress port for both ports. CPU refers to the Switch management port. By default it forms a VLAN with all Ethernet ports. If it does not form a VLAN with a particular port then the Switch cannot be managed from that port.</p>
Apply	<p>Click Apply to save your changes to the Switch's run-time memory. The Switch loses these changes if it is turned off or loses power, so use the Save link on the top navigation panel to save your changes to the non-volatile memory when you are done configuring.</p>
Cancel	<p>Click Cancel to begin configuring this screen afresh.</p>

CHAPTER 49

NETWORKING

The following chapters introduces the configurations of the links under the **NETWORKING** navigation panel.

Quick links to chapters:

- [ARP Setup](#)
- [DHCP](#)

CHAPTER 50

ARP Setup

50.1 ARP Overview

Address Resolution Protocol (ARP) is a protocol for mapping an Internet Protocol address (IP address) to a physical machine address, also known as a Media Access Control or MAC address, on the local area network.

An IP (version 4) address is 32 bits long. In an Ethernet LAN, MAC addresses are 48 bits long. The ARP table maintains an association between each MAC address and its corresponding IP address.

50.1.1 What You Can Do

Use the **ARP Learning** screen ([Section 50.2 on page 279](#)) to configure ARP learning mode on a per-port basis.

50.1.2 What You Need to Know

Read on for concepts on ARP that can help you configure the screen in this chapter.

50.1.2.1 How ARP Works

When an incoming packet destined for a host device on a local area network arrives at the Switch, the Switch looks in the ARP Table and if it finds the address, it sends it to the device.

If no entry is found for the IP address, ARP broadcasts the request to all the devices on the LAN. The Switch fills in its own MAC and IP address in the sender address fields, and puts the known IP address of the target in the target IP address field. In addition, the Switch puts all ones in the target MAC field (FF.FF.FF.FF.FF.FF is the Ethernet broadcast address). The replying device (which is either the IP address of the device being sought or the router that knows the way) replaces the broadcast address with the target's MAC address, swaps the sender and target pairs, and unicasts the answer directly back to the requesting machine. ARP updates the ARP Table for future reference and then sends the packet to the MAC address that replied.

50.1.2.2 ARP Learning Mode

The Switch supports three ARP learning modes: ARP-Reply, Gratuitous-ARP, and ARP-Request.

ARP-Reply

The Switch in ARP-Reply learning mode updates the ARP table only with the ARP replies to the ARP requests sent by the Switch. This can help prevent ARP spoofing.

In the following example, the Switch does not have IP address and MAC address mapping information for hosts **A** and **B** in its ARP table, and host **A** wants to ping host **B**. Host **A** sends an ARP request to the Switch and then sends an ICMP request after getting the ARP reply from the Switch. The Switch finds no matched entry for host **B** in the ARP table and broadcasts the ARP request to all the devices on the LAN. When the Switch receives the ARP reply from host **B**, it updates its ARP table and also forwards host **A**'s ICMP request to host **B**. After the Switch gets the ICMP reply from host **B**, it sends out an ARP request to get host **A**'s MAC address and updates the ARP table with host **A**'s ARP reply. The Switch then can forward host **B**'s ICMP reply to host **A**.

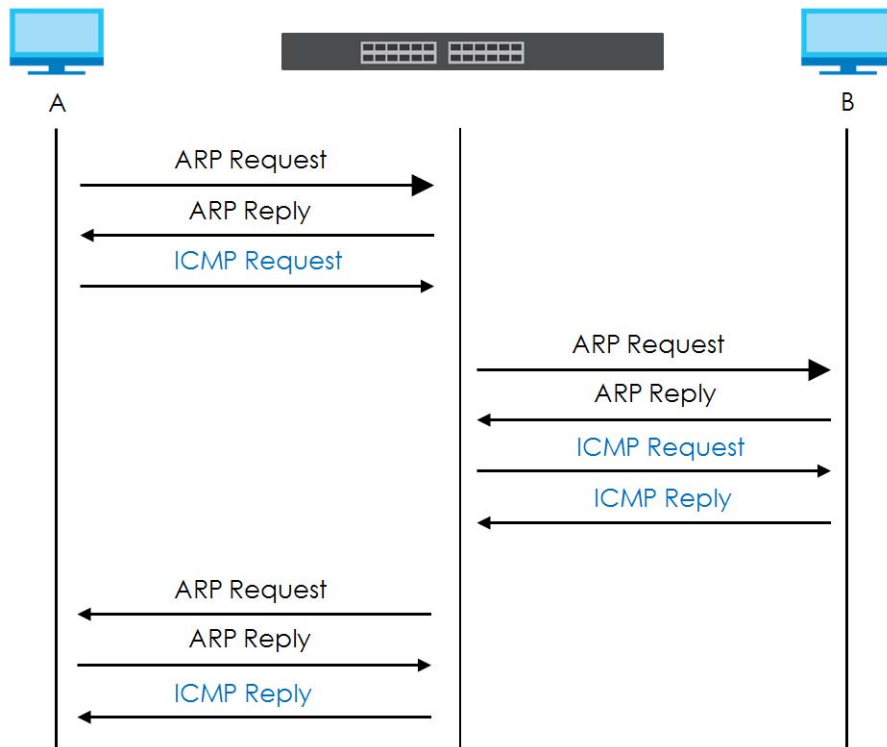

Gratuitous-ARP

A gratuitous ARP is an ARP request in which both the source and destination IP address fields are set to the IP address of the device that sends this request and the destination MAC address field is set to the broadcast address. There will be no reply to a gratuitous ARP request.

A device may send a gratuitous ARP packet to detect IP collisions. If a device restarts or its MAC address is changed, it can also use gratuitous ARP to inform other devices in the same network to update their ARP table with the new mapping information.

In Gratuitous-ARP learning mode, the Switch updates its ARP table with either an ARP reply or a gratuitous ARP request.

ARP-Request

When the Switch is in ARP-Request learning mode, it updates the ARP table with both ARP replies, gratuitous ARP requests and ARP requests.

Therefore in the following example, the Switch can learn host **A**'s MAC address from the ARP request sent by host **A**. The Switch then forwards host **B**'s ICMP reply to host **A** right after getting host **B**'s MAC

address and ICMP reply.

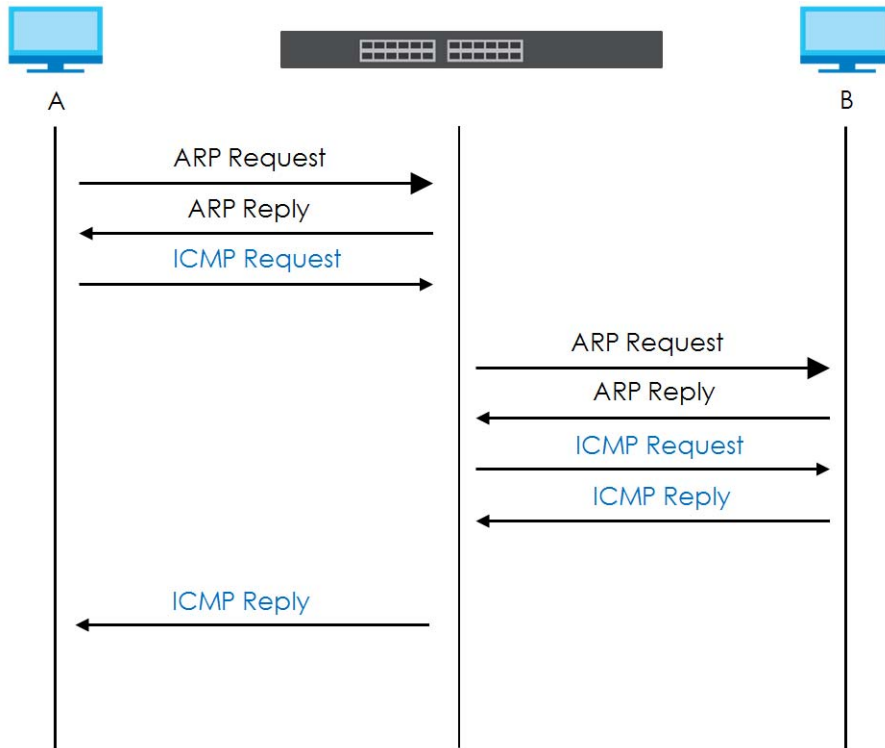

50.2 ARP Learning

Use this screen to configure each port's ARP learning mode. Click **NETWORKING > ARP Setup > ARP Learning** in the navigation panel to display the screen as shown next.

Figure 200 NETWORKING > ARP Setup > ARP Learning

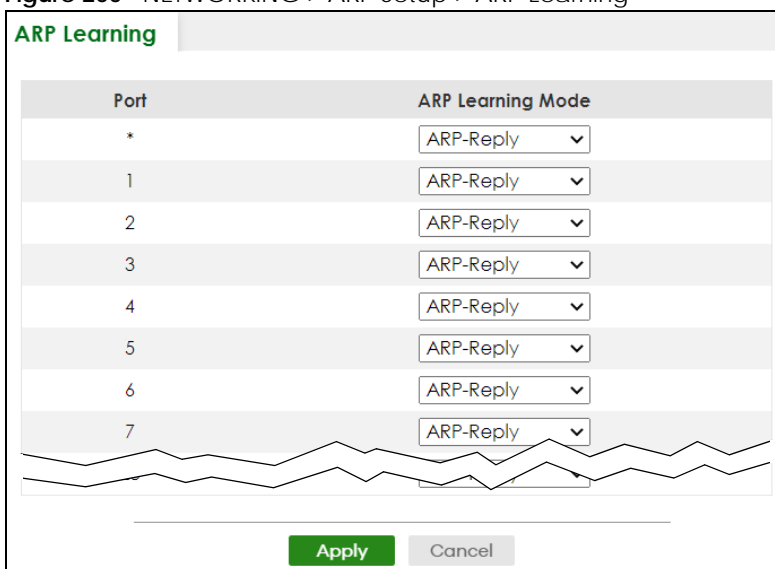

The following table describes the labels in this screen.

Table 145 NETWORKING > ARP Setup > ARP Learning

LABEL	DESCRIPTION
Port	This field displays the port number.
*	<p>Settings in this row apply to all ports.</p> <p>Use this row only if you want to make some settings the same for all ports. Use this row first to set the common settings and then make adjustments on a port-by-port basis.</p> <p>Changes in this row are copied to all the ports as soon as you make them.</p>
ARP Learning Mode	<p>Select the ARP learning mode the Switch uses on the port.</p> <p>Select ARP-Reply to have the Switch update the ARP table only with the ARP replies to the ARP requests sent by the Switch.</p> <p>Select Gratuitous-ARP to have the Switch update its ARP table with either an ARP reply or a gratuitous ARP request.</p> <p>Select ARP-Request to have the Switch update the ARP table with both ARP replies, gratuitous ARP requests and ARP requests.</p>
Apply	Click Apply to save your changes to the Switch's run-time memory. The Switch loses these changes if it is turned off or loses power, so use the Save link on the top navigation panel to save your changes to the non-volatile memory when you are done configuring.
Cancel	Click Cancel to begin configuring this screen afresh.

CHAPTER 51

DHCP

51.1 DHCP Overview

This chapter shows you how to configure the DHCP feature.

DHCP (Dynamic Host Configuration Protocol RFC 2131 and RFC 2132) allows individual computers to obtain TCP/IP configuration at start-up from a server. If you configure the Switch as a DHCP relay agent, then the Switch forwards DHCP requests to DHCP server on your network. If you do not configure the Switch as a DHCP relay agent then you must have a DHCP server in the broadcast domain of the client computers or else the client computers must be configured manually.

51.1.1 What You Can Do

- Use the **DHCPv4 Relay Status** screen ([Section 51.2 on page 282](#)) to display the relay mode and status.
- Use the **DHCPv4 Option 82 Profile** screen ([Section 51.4 on page 283](#)) to create DHCPv4 option 82 profiles.
- Use the **DHCPv4 Smart Relay** screen ([Section 51.5 on page 285](#)) to configure global DHCPv4 relay. You can also use this screen to apply different DHCP option 82 profile to certain ports on the Switch.
- Use the **DHCPv4 Relay VLAN Setting** screen ([Section 51.6 on page 289](#)) to configure your DHCPv4 settings based on the VLAN domain of the DHCPv4 clients. You can also use this screen to apply a different DHCP option 82 profile to certain ports in a VLAN.
- Use the **DHCPv6 Relay** screen ([Section 51.7 on page 292](#)) to enable and configure DHCPv6 relay.

51.1.2 What You Need to Know

Read on for concepts on DHCP that can help you configure the screens in this chapter.

DHCP Modes

If there is already a DHCP server on your network, then you can configure the Switch as a DHCP relay agent. When the Switch receives a request from a computer on your network, it contacts the DHCP server for the necessary IP information, and then relays the assigned information back to the computer.

DHCPv4 Configuration Options

The DHCPv4 configuration on the Switch is divided into **Smart Relay** and **VLAN** screens. The screen you should use for configuration depends on the DHCP services you want to offer the DHCP clients on your network. Choose the configuration screen based on the following criteria:

- **Smart Relay** – The Switch forwards all DHCP requests to the same DHCP server.

- **VLAN** – The Switch is configured on a VLAN by VLAN basis. The Switch can be configured to relay DHCP requests to different DHCP servers for clients in different VLAN.

51.2 DHCPv4 Relay Status

Click **NETWORKING > DHCP > DHCPv4 Relay** in the navigation panel. The **DHCP Relay Status** screen displays.

Figure 201 NETWORKING > DHCP > DHCPv4 Relay > DHCP Relay Status

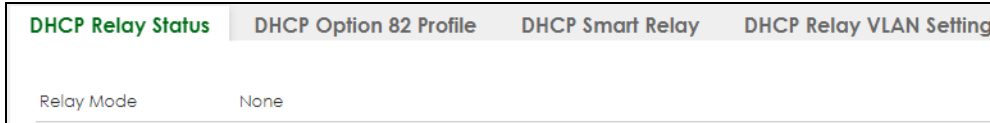

The following table describes the labels in this screen.

Table 146 NETWORKING > DHCP > DHCPv4 Relay > DHCP Relay Status

LABEL	DESCRIPTION
Relay Mode	This field displays: None – if the Switch is not configured as a DHCP relay agent. Smart – if the Switch is configured as a DHCP relay agent only. VLAN – followed by a VLAN ID or multiple VLAN IDs if it is configured as a relay agent for specific VLANs.

51.3 DHCPv4 Relay

Configure DHCP relay on the Switch if the DHCP clients and the DHCP server are not in the same broadcast domain. During the initial IP address leasing, the Switch helps to relay network information (such as the IP address and subnet mask) between a DHCP client and a DHCP server. Once the DHCP client obtains an IP address and can connect to the network, network information renewal is done between the DHCP client and the DHCP server without the help of the Switch.

The Switch can be configured as a global DHCP relay. This means that the Switch forwards all DHCP requests from all domains to the same DHCP server. You can also configure the Switch to relay DHCP information based on the VLAN membership of the DHCP clients.

51.3.1 DHCPv4 Relay Agent Information

The Switch can add information about the source of client DHCP requests that it relays to a DHCP server by adding **Relay Agent Information**. This helps provide authentication about the source of the requests. The DHCP server can then provide an IP address based on this information. Please refer to RFC 3046 for more details.

The DHCP **Relay Agent Information** feature adds an Agent Information field (also known as the **Option 82** field) to DHCP requests. The **Option 82** field is in the DHCP headers of client DHCP request frames that the Switch relays to a DHCP server.

Relay Agent Information can include the **System Name** of the Switch if you select this option. You can change the **System Name** in **SYSTEM > General Setup**.

The following describes the DHCP relay agent information that the Switch sends to the DHCP server:

Table 147 Relay Agent Information

FIELD LABELS	DESCRIPTION
Slot ID	(1 byte) This value is always 0 for stand-alone switches.
Port ID	(1 byte) This is the port that the DHCP client is connected to.
VLAN ID	(2 bytes) This is the VLAN that the port belongs to.
Information	(up to 64 bytes) This optional, read-only field is set according to system name set in SYSTEM > General Setup .

51.3.1.1 DHCPv4 Relay Agent Information Format

A DHCP Relay Agent Information option has the following format.

Table 148 DHCP Relay Agent Information Option Format

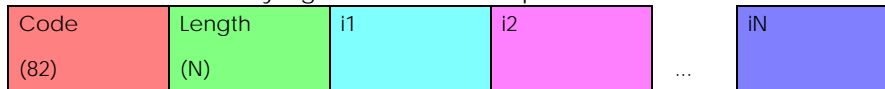

i1, i2 and iN are DHCP relay agent sub-options, which contain additional information about the DHCP client. You need to define at least one sub-option.

51.3.1.2 Sub-Option Format

There are two types of sub-option: “Agent Circuit ID Sub-option” and “Agent Remote ID Sub-option”. They have the following formats.

Table 149 DHCP Relay Agent Circuit ID Sub-option Format

SubOpt Code	Length	Value
1 (1 byte)	N (1 byte)	Slot ID, Port ID, VLAN ID, System Name or String

Table 150 DHCP Relay Agent Remote ID Sub-option Format

SubOpt Code	Length	Value
2 (1 byte)	N (1 byte)	MAC Address or String

The 1 in the first field identifies this as an Agent Circuit ID sub-option and two identifies this as an Agent Remote ID sub-option. The next field specifies the length of the field.

51.4 DHCPv4 Option 82 Profile

Use this screen to view and configure DHCPv4 option 82 profiles. Click **NETWORKING > DHCP > DHCPv4 Relay > DHCP Option 82 Profile** link to display the screen as shown.

Figure 202 NETWORKING > DHCP > DHCPv4 Relay > DHCP Option 82 Profile

<input type="checkbox"/>	Profile Name	Enable	Circuit-ID	Field	Enable	Remote-ID	Field
<input checked="" type="checkbox"/>	default1	ON		slot-port, vlan	OFF		-
<input type="checkbox"/>	default2	ON		slot-port, vlan, hostname	OFF		-

The following table describes the labels in this screen.

Table 151 NETWORKING > DHCP > DHCPv4 Relay > DHCP Option 82 Profile

LABEL	DESCRIPTION
Profile Name	This field displays the descriptive name of the profile.
Circuit-ID	This section displays the Circuit ID sub-option including information that is specific to the relay agent (the Switch).
Enable	This field displays whether the Circuit ID sub-option is added to client DHCP requests.
Field	This field displays the information that is included in the Circuit ID sub-option.
Remote-ID	This section displays the Remote ID sub-option including information that identifies the relay agent (the Switch).
Enable	This field displays whether the Remote ID sub-option is added to client DHCP requests.
Field	This field displays the information that is included in the Remote ID sub-option.
	Select an entry's checkbox to select a specific entry. Otherwise, select the checkbox in the table heading row to select all entries.
Add/Edit	Click Add/Edit to add a new entry or edit a selected one.
Delete	Click Delete to remove the selected entries.

51.4.1 Add/Edit a DHCPv4 Option 82 Profile

Use this screen to create DHCPv4 option 82 profiles. Click **Add/Edit**, or select an entry and click **Add/Edit** in the **NETWORKING > DHCP > DHCPv4 Relay > DHCP Option 82 Profile** link to display this screen.

Figure 203 NETWORKING > DHCP > DHCPv4 Relay > DHCP Option 82 Profile > Add/Edit

Note: The string of any field in this screen should not contain [?], [|], ['], ["] or [,].

The following table describes the labels in this screen.

Table 152 NETWORKING > DHCP > DHCPv4 Relay > DHCP Option 82 Profile > Add/Edit

LABEL	DESCRIPTION
Name	Enter a descriptive name for the profile for identification purposes. You can use up to 32 printable ASCII characters.
Circuit-ID	Use this section to configure the Circuit ID sub-option to include information that is specific to the relay agent (the Switch).
Enable	Select this option to have the Switch add the Circuit ID sub-option to client DHCP requests that it relays to a DHCP server.
slot-port	Select this option to have the Switch add the number of port that the DHCP client is connected to.
vlan	Select this option to have the Switch add the ID of VLAN which the port belongs to.
hostname	This is the system name you configure in the SYSTEM > General Setup screen. Select this option for the Switch to add the system name to the client DHCP requests that it relays to a DHCP server.
string	Enter a string of up to 64 printable ASCII characters that the Switch adds into the client DHCP requests.
Remote-ID	Use this section to configure the Remote ID sub-option to include information that identifies the relay agent (the Switch).
Enable	Select this option to have the Switch append the Remote ID sub-option to the option 82 field of DHCP requests.
mac	Select this option to have the Switch add its MAC address to the client DHCP requests that it relays to a DHCP server.
string	Enter a string of up to 64 printable ASCII characters for the remote ID information in this field.
Apply	Click Apply to save your changes to the Switch's run-time memory. The Switch loses these changes if it is turned off or loses power, so use the Save link on the top navigation panel to save your changes to the non-volatile memory when you are done configuring.
Clear	Click Clear to clear the fields to the factory defaults.
Cancel	Click Cancel to not save the configuration you make and return to the last screen.

51.5 Configure a DHCPv4 Smart Relay

Use this screen to configure global DHCPv4 relay. Click **NETWORKING > DHCP > DHCPv4 Relay > DHCP Smart Relay** to display the screen as shown.

Figure 204 NETWORKING > DHCP > DHCPv4 Relay > DHCP Smart Relay

The following table describes the labels in this screen.

Table 153 NETWORKING > DHCP > DHCPv4 Relay > DHCP Smart Relay

LABEL	DESCRIPTION
DHCP Smart Relay	
Active	Select this checkbox to enable DHCPv4 relay.
Remote DHCP Server 1 .. 3	Enter the IP address of a DHCPv4 server in dotted decimal notation.
Option 82 Profile	Select a pre-defined DHCPv4 option 82 profile that the Switch applies to all ports. The Switch adds the Circuit ID sub-option and/or Remote ID sub-option specified in the profile to DHCP requests that it relays to a DHCP server.
Apply	Click Apply to save your changes to the Switch's run-time memory. The Switch loses these changes if it is turned off or loses power, so use the Save link on the top navigation panel to save your changes to the non-volatile memory when you are done configuring.
Cancel	Click Cancel to begin configuring this screen afresh.
Port	
Use this section to apply a different DHCP option 82 profile to certain ports on the Switch.	
Index	This field displays a sequential number for each entry.
Port	This field displays the ports to which the Switch applies the settings.
Profile Name	This field displays the DHCP option 82 profile that the Switch applies to the ports.
	Select an entry's checkbox to select a specific entry. Otherwise, select the checkbox in the table heading row to select all entries.
Add/Edit	Click Add/Edit to add a new entry or edit a selected one.
Delete	Click Delete to remove the selected entries.

51.5.1 Add/Edit DHCPv4 Global Relay Port

Use this screen to apply a different DHCP option 82 profile to certain ports on the Switch. To open this screen, Click **Add/Edit**, or select an entry and click **Add/Edit** in the **Port** section of the **NETWORKING > DHCP > DHCPv4 Relay > DHCP Smart Relay** screen.

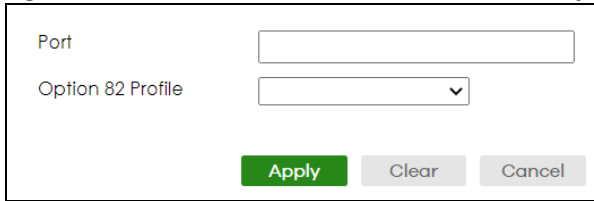
Figure 205 NETWORKING > DHCP > DHCPv4 Relay > DHCP Smart Relay > Add/Edit

The following table describes the labels in this screen.

Table 154 NETWORKING > DHCP > DHCPv4 Relay > DHCP Smart Relay > Add/Edit

LABEL	DESCRIPTION
Port	Enter the number of ports to which you want to apply the specified DHCP option 82 profile. You can enter multiple ports separated by (no space) comma (,) or hyphen (-). For example, enter "3-5" for ports 3, 4, and 5. Enter "3,5,7" for ports 3, 5, and 7.
Option 82 Profile	Select a pre-defined DHCP option 82 profile that the Switch applies to the specified ports. The Switch adds the Circuit ID sub-option and/or Remote ID sub-option specified in the profile to DHCP requests that it relays to a DHCP server. The profile you select here has priority over the one you select in the NETWORKING > DHCP > DHCPv4 Relay > DHCPv4 Smart Relay screen.
Apply	Click Apply to save your changes to the Switch's run-time memory. The Switch loses these changes if it is turned off or loses power, so use the Save link on the top navigation panel to save your changes to the non-volatile memory when you are done configuring.
Clear	Click Clear to clear the fields to the factory defaults.
Cancel	Click Cancel to not save the configuration you make and return to the last screen.

51.5.2 DHCP Smart Relay Configuration Example

The follow figure shows a network example where the Switch is used to relay DHCP requests for the **VLAN1** and **VLAN2** domains. There is only one DHCP server that services the DHCP clients in both domains.

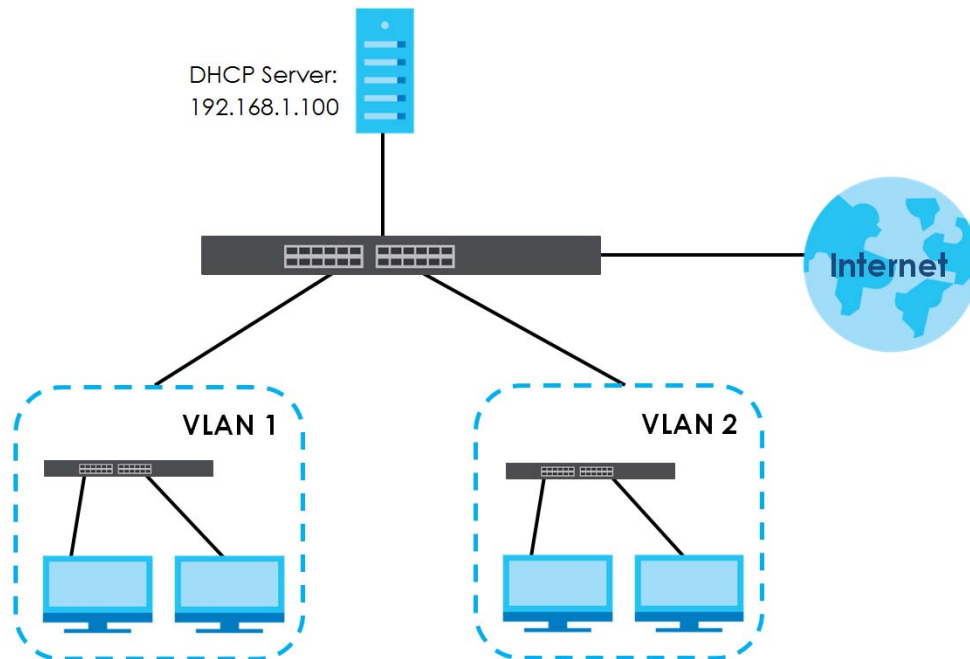
Figure 206 DHCP Smart Relay Network Example

Configure the **NETWORKING > DHCP > DHCPv4 Relay > DHCP Smart Relay** screen as shown. Make sure you select a DHCP option 82 profile (**default1** in this example) to set the Switch to send additional information (such as the VLAN ID) together with the DHCP requests to the DHCP server. This allows the DHCP server to assign the appropriate IP address according to the VLAN ID. Click **Apply** after you finish the configuration.

Figure 207 DHCP Relay Configuration Example

DHCP Status
DHCP Option 82 Profile
DHCP Smart Relay

DHCP Smart Relay

Active ON

Remote DHCP Server 1

Remote DHCP Server 2

Remote DHCP Server 3

Option 82 Profile

Apply
Cancel

Port

+ Add/Edit
 - Delete

<input type="checkbox"/>	Index	Port	Profile Name
<input type="checkbox"/>			

51.6 DHCPv4 VLAN Setting

Use this screen to configure your DHCP settings based on the VLAN domain of the DHCP clients. Click **NETWORKING > DHCP > DHCPv4 Relay > DHCP Relay VLAN Setting** to display the screen as shown.

Figure 208 NETWORKING > DHCP > DHCPv4 Relay > DHCP Relay VLAN Setting

The following table describes the labels in this screen.

Table 155 NETWORKING > DHCP > DHCPv4 Relay > DHCP Relay VLAN Setting

LABEL	DESCRIPTION
DHCP Relay VLAN Setting	
VID	This field displays the ID number of the VLAN group to which this DHCP settings apply.
Remote DHCP Server	This displays the IP address of a DHCP server in dotted decimal notation.
Profile Name	This field displays the DHCP option 82 profile that the Switch applies to this VLAN.
	Select an entry's checkbox to select a specific entry. Otherwise, select the checkbox in the table heading row to select all entries.
Add/Edit	Click Add/Edit to add a new entry or edit a selected one.
Delete	Click Delete to remove the selected entries.
Port	
Use this section to apply a different DHCP option 82 profile to certain ports in a VLAN.	
Index	This field displays a sequential number for each entry. Click an index number to change the settings.
VID	This field displays the VLAN to which the ports belongs.
Port	This field displays the ports to which the Switch applies the settings.
Profile Name	This field displays the DHCP option 82 profile that the Switch applies to the ports in this VLAN.
	Select an entry's checkbox to select a specific entry. Otherwise, select the checkbox in the table heading row to select all entries.
Add/Edit	Click Add/Edit to add a new entry or edit a selected one.
Delete	Click Delete to remove the selected entries.

51.6.1 Add/Edit DHCPv4 VLAN Setting

Use this screen to add/edit your DHCP settings based on the VLAN domain of the DHCP clients. Click the **Add/Edit** button in the **DHCP Relay VLAN Setting** section of the **NETWORKING > DHCP > DHCPv4 Relay > DHCP Relay VLAN Setting** screen to access this screen.

Note: You must set up a management IP address for each VLAN that you want to configure DHCP settings for on the Switch.

Figure 209 NETWORKING > DHCP > DHCPv4 Relay > DHCP Relay VLAN Setting > Add/Edit (DHCP Relay VLAN Setting)

The screenshot shows a configuration form with the following elements:

- VID: A text input field.
- Remote DHCP Server 1: A text input field containing "0.0.0.0".
- Remote DHCP Server 2: A text input field containing "0.0.0.0".
- Remote DHCP Server 3: A text input field containing "0.0.0.0".
- Option 82 Profile: A dropdown menu.
- Buttons: "Apply" (green), "Clear" (grey), and "Cancel" (grey).

The following table describes the labels in this screen.

Table 156 NETWORKING > DHCP > DHCPv4 Relay > DHCP Relay VLAN Setting > Add/Edit (DHCP Relay VLAN Setting)

LABEL	DESCRIPTION
VID	Enter the ID number of the VLAN to which these DHCP settings apply.
Remote DHCP Server 1 .. 3	Enter the IP address of a DHCP server in dotted decimal notation.
Option 82 Profile	Select a pre-defined DHCP option 82 profile that the Switch applies to all ports in this VLAN. The Switch adds the Circuit ID sub-option and/or Remote ID sub-option specified in the profile to DHCP requests that it relays to a DHCP server.
Apply	Click Apply to save your changes to the Switch's run-time memory. The Switch loses these changes if it is turned off or loses power, so use the Save link on the top navigation panel to save your changes to the non-volatile memory when you are done configuring.
Clear	Click Clear to clear the fields to the factory defaults.
Cancel	Click Cancel to not save the configuration you make and return to the last screen.

51.6.2 Add/Edit DHCPv4 VLAN Port

Use this screen to apply a different DHCP option 82 profile to certain ports in a VLAN. Click the **Add/Edit** button in the **Port** section of the **NETWORKING > DHCP > DHCPv4 Relay > DHCP Relay VLAN Setting** screen to access this screen.

Figure 210 NETWORKING > DHCP > DHCPv4 Relay > DHCP Relay VLAN Setting > Add/Edit (Port)

The screenshot shows a configuration form with the following elements:

- VID: A text input field.
- Port: A text input field.
- Option 82 Profile: A dropdown menu.
- Buttons: "Apply" (green), "Clear" (grey), and "Cancel" (grey).

The following table describes the labels in this screen.

Table 157 NETWORKING > DHCP > DHCPv4 Relay > DHCP Relay VLAN Setting > Add/Edit (Port)

LABEL	DESCRIPTION
VID	Enter the ID number of the VLAN you want to configure here.
Port	Enter the number of ports to which you want to apply the specified DHCP option 82 profile. You can enter multiple ports separated by (no space) comma (,) or hyphen (-). For example, enter "3-5" for ports 3, 4, and 5. Enter "3,5,7" for ports 3, 5, and 7.
Option 82 Profile	Select a pre-defined DHCP option 82 profile that the Switch applies to the specified ports in this VLAN. The Switch adds the Circuit ID sub-option and/or Remote ID sub-option specified in the profile to DHCP requests that it relays to a DHCP server. The profile you select here has priority over the one you select in the NETWORKING > DHCP > DHCPv4 Relay > DHCP Relay VLAN Setting (the DHCP Relay VLAN Setting section) > Add/Edit screen.
Apply	Click Apply to save your changes to the Switch's run-time memory. The Switch loses these changes if it is turned off or loses power, so use the Save link on the top navigation panel to save your changes to the non-volatile memory when you are done configuring.
Clear	Click Clear to clear the fields to the factory defaults.
Cancel	Click Cancel to not save the configuration you make and return to the last screen.

51.6.3 Example: DHCP Relay for Two VLANs

The following example displays two VLANs (VIDs 1 and 2) for a campus network. Two DHCP servers are installed to serve each VLAN. The system is set up to forward DHCP requests from the dormitory rooms (VLAN 1) to the DHCP server with an IP address of 192.168.1.100. Requests from the academic buildings (VLAN 2) are sent to the other DHCP server with an IP address of 172.16.10.100.

Figure 211 DHCP Relay for Two VLANs

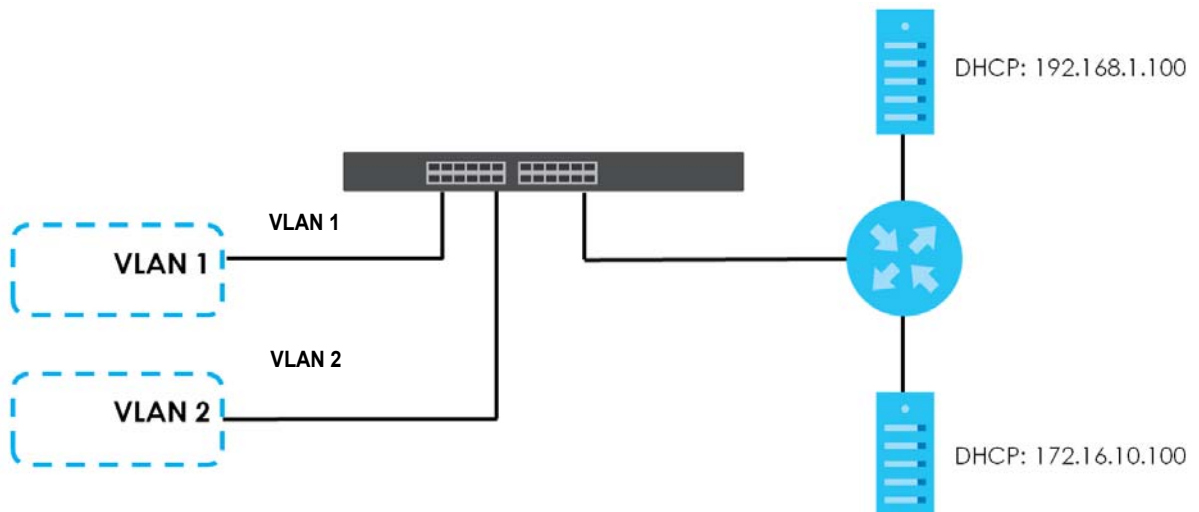

For the example network, add two entries in **DHCP Relay VLAN Setting** section of the **NETWORKING > DHCP > DHCPv4 Relay > DHCP Relay VLAN Setting** screen as shown.

Figure 212 DHCP Relay for Two VLANs Configuration Example

51.7 DHCPv6 Relay

A DHCPv6 relay agent is on the same network as the DHCPv6 clients and helps forward messages between the DHCPv6 server and clients. When a client cannot use its link-local address and a well-known multicast address to locate a DHCPv6 server on its network, it then needs a DHCPv6 relay agent to send a message to a DHCPv6 server that is not attached to the same network.

The DHCPv6 relay agent can add the remote identification (remote-ID) option and the interface-ID option to the Relay-Forward DHCPv6 messages. The remote-ID option carries a user-defined string, such as the system name. The interface-ID option provides slot number, port information and the VLAN ID to the DHCPv6 server. The remote-ID option (if any) is stripped from the Relay-Reply messages before the relay agent sends the packets to the clients. The DHCPv6 server copies the interface-ID option from the Relay-Forward message into the Relay-Reply message and sends it to the relay agent. The interface-ID should not change even after the relay agent restarts.

Use this screen to view and configure DHCPv6 relay settings for a specific VLAN on the Switch. Click **NETWORKING > DHCP > DHCPv6 Relay** in the navigation panel to display the screen as shown.

Figure 213 NETWORKING > DHCP > DHCPv6 Relay

The following table describes the labels in this screen.

Table 158 NETWORKING > DHCP > DHCPv6 Relay

LABEL	DESCRIPTION
VID	This field displays the VLAN ID number.
Helper Address	This field displays the IPv6 address of the remote DHCPv6 server for this VLAN.

Table 158 NETWORKING > DHCP > DHCPv6 Relay (continued)

LABEL	DESCRIPTION
Interface ID	This field displays whether the interface-ID option is added to DHCPv6 requests from clients in this VLAN.
Remote ID	This field displays whether the remote-ID option is added to DHCPv6 requests from clients in this VLAN.
	Select an entry's checkbox to select a specific entry. Otherwise, select the checkbox in the table heading row to select all entries.
Add/Edit	Click Add/Edit to add a new entry or edit a selected one.
Delete	Click Delete to remove the selected entries.

51.7.1 Add/Edit DHCPv6 Relay

Use this screen to add/edit DHCPv6 relay settings for a specific VLAN on the Switch. Click **Add/Edit**, or select an entry and click **Add/Edit** in the **NETWORKING > DHCP > DHCPv6 Relay** screen to display this screen.

Figure 214 NETWORKING > DHCP > DHCPv6 Relay > Add/Edit

The following table describes the labels in this screen.

Table 159 NETWORKING > DHCP > DHCPv6 Relay > Add/Edit

LABEL	DESCRIPTION
VID	Enter the ID number of the VLAN you want to configure here.
Helper Address	Enter the remote DHCPv6 server address for the specified VLAN.
Interface ID	Enable the switch button to have the Switch add the interface-ID option in the DHCPv6 requests from the clients in the specified VLAN before the Switch forwards them to a DHCPv6 server.
Remote ID	Enter a string of up to 64 printable ASCII characters (except [?], [], ['], ["] or [,]) to be carried in the remote-ID option. The Switch adds the remote-ID option in the DHCPv6 requests from the clients in the specified VLAN before the Switch forwards them to a DHCPv6 server.
Apply	Click Apply to save your changes to the Switch's run-time memory. The Switch loses these changes if it is turned off or loses power, so use the Save link on the top navigation panel to save your changes to the non-volatile memory when you are done configuring.
Clear	Click Clear to clear the fields to the factory defaults.
Cancel	Click Cancel to not save the configuration you make and return to the last screen.

CHAPTER 52

SECURITY

The following chapters introduces the configurations of the links under the **SECURITY** navigation panel.

Quick links to chapters:

- [AAA](#)
- [Access Control](#)
- [Storm Control](#)
- [Error-Disable](#)
- [DHCP Snooping](#)
- [Port Security](#)

CHAPTER 53

AAA

53.1 Authentication, Authorization and Accounting (AAA)

This chapter describes how to configure authentication, authorization and accounting settings on the Switch.

The external servers that perform authentication, authorization and accounting functions are known as AAA servers. The Switch supports RADIUS (Remote Authentication Dial-In User Service) as the external authentication, authorization, and accounting server.

Figure 215 AAA Server

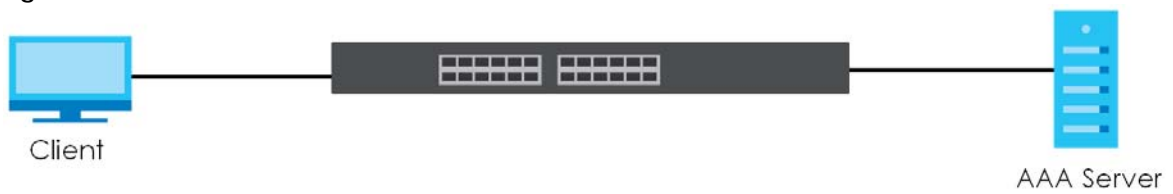

53.1.1 What You Can Do

- use the **RADIUS Server Setup** screen ([Section 53.2 on page 296](#)) to configure your RADIUS server settings.
- Use the **AAA Setup** screen ([Section 53.3 on page 298](#)) to configure authentication, authorization and accounting settings, such as the methods used to authenticate users accessing the Switch and which database the Switch should use first.

53.1.2 What You Need to Know

Authentication is the process of determining who a user is and validating access to the Switch. The Switch can authenticate users who try to log in based on user accounts configured on the Switch itself. The Switch can also use an external authentication server to authenticate a large number of users.

Authorization is the process of determining what a user is allowed to do. Different user accounts may have higher or lower privilege levels associated with them. For example, user A may have the right to create new login accounts on the Switch but user B cannot. The Switch can authorize users based on user accounts configured on the Switch itself or it can use an external server to authorize a large number of users.

Accounting is the process of recording what a user is doing. The Switch can use an external server to track when users log in, log out, execute commands and so on. Accounting can also record system related actions such as boot up and shut down times of the Switch.

Local User Accounts

By storing user profiles locally on the Switch, your Switch is able to authenticate and authorize users without interacting with a network AAA server. However, there is a limit on the number of users you may authenticate in this way.

RADIUS

RADIUS is a security protocol used to authenticate users by means of an external server instead of (or in addition to) an internal device user database that is limited to the memory capacity of the device. In essence, RADIUS authentication allows you to validate an unlimited number of users from a central location.

53.2 RADIUS Server Setup

Use this screen to configure your RADIUS server settings. Click **SECURITY > AAA > RADIUS Server Setup** to view the screen as shown.

Figure 216 SECURITY > AAA > RADIUS Server Setup

RADIUS Server Setup

Authentication Server

Mode: ▾

Timeout: seconds

Delete	Index	IP Address	UDP Port	Shared Secret	Encrypted Shared Secret
<input type="checkbox"/>	1	<input type="text"/>	1812	<input type="text"/>	<input type="text"/>
<input type="checkbox"/>	2	<input type="text"/>	1812	<input type="text"/>	<input type="text"/>

Accounting Server

Timeout: seconds

Delete	Index	IP Address	UDP Port	Shared Secret	Encrypted Shared Secret
<input type="checkbox"/>	1	<input type="text"/>	1813	<input type="text"/>	<input type="text"/>
<input type="checkbox"/>	2	<input type="text"/>	1813	<input type="text"/>	<input type="text"/>

Attribute

NAS-IP-Address:

The following table describes the labels in this screen.

Table 160 SECURITY > AAA > RADIUS Server Setup

LABEL	DESCRIPTION
Authentication Server	
Use this section to configure your RADIUS authentication settings.	
Mode	<p>This field is only valid if you configure multiple RADIUS servers.</p> <p>Select index-priority and the Switch tries to authenticate with the first configured RADIUS server, if the RADIUS server does not respond then the Switch tries to authenticate with the second RADIUS server.</p> <p>Select round-robin to alternate between the RADIUS servers that it sends authentication requests to.</p>
Timeout	<p>Specify the amount of time in seconds that the Switch waits for an authentication request response from the RADIUS server.</p> <p>If you are using two RADIUS servers then the timeout value is divided between the two RADIUS servers. For example, if you set the timeout value to 30 seconds, then the Switch waits for a response from the first RADIUS server for 15 seconds and then tries the second RADIUS server.</p>
Delete	Check this box if you want to remove an existing RADIUS server entry from the Switch. This entry is deleted when you click Apply .
Index	This is a read-only number representing a RADIUS server entry.
IP Address	Enter the IPv4 address or IPv6 address of an external RADIUS server.
UDP Port	The default port of a RADIUS server for authentication is 1812 . You need not change this value unless your network administrator instructs you to do so.
Shared Secret	Specify a password (up to 32 alphanumeric characters except [?], [], ['], ["], [space], or [,]) as the key to be shared between the external RADIUS server and the Switch. This key is not sent over the network. This key must be the same on the external RADIUS server and the Switch.
Encrypted Shared Secret	<p>This displays the encrypted shared secret in '**' format if you enabled Server Key Encryption in SECURITY > AAA > AAA Setup.</p> <p>Note: If you forget the key you set, simply reset the key in the Shared Secret field. If a key is encrypted, it will remain in the encrypted format even if you later disable Server Key Encryption in SECURITY > AAA > AAA Setup.</p> <p>Note: The shared secret displayed in this field does not present the actual length of the shared secret.</p>
Accounting Server	
Use this section to configure your RADIUS accounting server settings.	
Timeout	Specify the amount of time in seconds that the Switch waits for an accounting request response from the RADIUS accounting server.
Delete	Check this box if you want to remove an existing RADIUS accounting server entry from the Switch. This entry is deleted when you click Apply .
Index	This is a read-only number representing a RADIUS accounting server entry.
IP Address	Enter the IPv4 address or IPv6 address of an external RADIUS accounting server.
UDP Port	The default port of a RADIUS accounting server for accounting is 1813 . You need not change this value unless your network administrator instructs you to do so.
Shared Secret	Specify a password (up to 32 alphanumeric characters except [?], [], ['], ["], [space], or [,]) as the key to be shared between the external RADIUS accounting server and the Switch. This key is not sent over the network. This key must be the same on the external RADIUS accounting server and the Switch.

Table 160 SECURITY > AAA > RADIUS Server Setup (continued)

LABEL	DESCRIPTION
Encrypted Shared Secret	<p>This displays the encrypted shared secret in '**' format if you enabled Server Key Encryption in SECURITY > AAA > AAA Setup.</p> <p>Note: If you forget the key you set, simply reset the key in the Shared Secret field. If a key is encrypted, it will remain in the encrypted format even if you later disable Server Key Encryption in SECURITY > AAA > AAA Setup.</p> <p>Note: The shared secret displayed in this field does not present the actual length of the shared secret.</p>
<p>Attribute</p> <p>Use this section to define the RADIUS server attribute for its account.</p>	
NAS-IP-Address	Enter the IP address of the NAS (Network Access Server).
Apply	Click Apply to save your changes to the Switch's run-time memory. The Switch loses these changes if it is turned off or loses power, so use the Save link on the top navigation panel to save your changes to the non-volatile memory when you are done configuring.
Cancel	Click Cancel to begin configuring this screen afresh.

53.3 AAA Setup

Use this screen to configure authentication, authorization and accounting settings on the Switch. Click **SECURITY > AAA > AAA Setup** to view the screen as shown.

Figure 217 SECURITY > AAA > AAA Setup

AAA Setup

Server Key Encryption

Active

Authentication

Type	Method 1	Method 2
Privilege Enable	local	-
Login	local	-

Authorization

Type	Active	Console	Method
Exec	<input checked="" type="checkbox"/>	<input type="checkbox"/>	radius

Accounting

Update Period minutes

Type	Active	Broadcast	Mode	Method	Privilege
System	<input checked="" type="checkbox"/>	<input type="checkbox"/>	-	radius	-
Exec	<input checked="" type="checkbox"/>	<input type="checkbox"/>	start-stop	radius	-

The following table describes the labels in this screen.

Table 161 SECURITY > AAA > AAA Setup

LABEL	DESCRIPTION
Server Key Encryption	
Use this section to configure server key encryption settings.	
Active	<p>Enable the switch button to enable server key (shared secret) encryption for RADIUS server for security enhancement.</p> <p>The shared secret will be stored on the Switch in an encrypted format and displayed as '*' in the SECURITY > AAA > RADIUS Server Setup screen.</p>
Authentication	
Use this section to specify the methods used to authenticate users accessing the Switch.	

Table 161 SECURITY > AAA > AAA Setup (continued)

LABEL	DESCRIPTION
Privilege Enable	<p>These fields specify which database the Switch should use (first, second and third) to authenticate access privilege level for administrator accounts (users for Switch management).</p> <p>Configure the access privilege of accounts through commands (See the CLI Reference Guide) for local authentication. The RADIUS is an external server. Before you specify the priority, make sure you have set up the corresponding database correctly first.</p> <p>You can specify up to two methods for the Switch to authenticate the access privilege level of administrators. The Switch checks the methods in the order you configure them (first Method 1, and then Method 2). You must configure the settings in the Method 1 field. If you want the Switch to check another source for access privilege level specify it in the Method 2 field.</p> <p>Select local to have the Switch check the access privilege configured for local authentication.</p> <p>Select radius to have the Switch check the access privilege through the external server.</p>
Login	<p>These fields specify which database the Switch should use (first and second) to authenticate administrator accounts (users for Switch management).</p> <p>Configure the local user accounts in the SYSTEM > Logins screen. The RADIUS is an external server. Before you specify the priority, make sure you have set up the corresponding database correctly first.</p> <p>You can specify up to two methods for the Switch to authenticate administrator accounts. The Switch checks the methods in the order you configure them (first Method 1, and then Method 2). You must configure the settings in the Method 1 field. If you want the Switch to check another source for administrator accounts, specify them in the Method 2 field.</p> <p>Select local to have the Switch check the administrator accounts configured in the SYSTEM > Logins screen.</p> <p>Select radius to have the Switch check the administrator accounts configured through your RADIUS server.</p>
<p>Authorization</p> <p>Use this section to configure authorization settings on the Switch.</p>	
Type	<p>Set whether the Switch provides the following services to a user.</p> <ul style="list-style-type: none"> • Exec: Allow an administrator which logs into the Switch through Telnet or SSH to have a different access privilege level assigned through the external server.
Active	<p>Enable the switch button to activate authorization for a specified event type.</p>
Console	<p>Select this to allow an administrator which logs in the Switch through the console port to have different access privilege level assigned through the external server.</p>
Method	<p>RADIUS is the only method for authorization of the Exec type of service.</p>
<p>Accounting</p> <p>Use this section to configure accounting settings on the Switch.</p>	
Update Period	<p>This is the amount of time in minutes before the Switch sends an update to the accounting server. This is only valid if you select the start-stop option for the Exec entries.</p>
Type	<p>The Switch supports the following types of events to be sent to the accounting servers:</p> <ul style="list-style-type: none"> • System – Configure the Switch to send information when the following system events occur: system boots up, system shuts down, system accounting is enabled, system accounting is disabled. • Exec – Configure the Switch to send information when an administrator logs in and logs out through the console port, telnet or SSH.
Active	<p>Enable the switch button to activate accounting for a specified event type.</p>

Table 161 SECURITY > AAA > AAA Setup (continued)

LABEL	DESCRIPTION
Broadcast	<p>Select this to have the Switch send accounting information to all configured accounting servers at the same time.</p> <p>If you do not select this and you have two accounting servers set up, then the Switch sends information to the first accounting server and if it does not get a response from the accounting server then it tries the second accounting server.</p>
Mode	<p>The Switch supports two modes of recording login events. Select:</p> <ul style="list-style-type: none"> • start-stop – to have the Switch send information to the accounting server when a user begins a session, during a user’s session (if it lasts past the Update Period), and when a user ends a session. • stop-only – to have the Switch send information to the accounting server only when a user ends a session.
Method	RADIUS is the only method for recording System or Exec type of event.
Privilege	This field is not configurable for System and Exec types of events.
Apply	Click Apply to save your changes to the Switch’s run-time memory. The Switch loses these changes if it is turned off or loses power, so use the Save link on the top navigation panel to save your changes to the non-volatile memory when you are done configuring.
Cancel	Click Cancel to begin configuring this screen afresh.

53.4 Technical Reference

This section provides technical background information on the topics discussed in this chapter.

53.4.1 Vendor Specific Attribute

RFC 2865 standard specifies a method for sending vendor-specific information between a RADIUS server and a network access device (for example, the Switch). A company can create Vendor Specific Attributes (VSAs) to expand the functionality of a RADIUS server.

The Switch supports VSAs that allow you to perform the following actions based on user authentication:

- Limit bandwidth on incoming or outgoing traffic for the port the user connects to.
- Assign account privilege levels (See the CLI Reference Guide for more information on account privilege levels) for the authenticated user.

The VSAs are composed of the following:

- **Vendor-ID**: An identification number assigned to the company by the IANA (Internet Assigned Numbers Authority). Zyxel’s vendor ID is 890.
- **Vendor-Type**: A vendor specified attribute, identifying the setting you want to modify.
- **Vendor-data**: A value you want to assign to the setting.

Note: Refer to the documentation that comes with your RADIUS server on how to configure VSAs for users authenticating through the RADIUS server.

The following table describes the VSAs supported on the Switch.

Table 162 Supported VSAs

FUNCTION	ATTRIBUTE
Ingress Bandwidth Assignment	Vendor-Id = 890 Vendor-Type = 1 Vendor-data = ingress rate (Kbps in decimal format)
Egress Bandwidth Assignment	Vendor-Id = 890 Vendor-Type = 2 Vendor-data = egress rate (Kbps in decimal format)
Privilege Assignment	Vendor-ID = 890 Vendor-Type = 3 Vendor-Data = " shell:priv-lvl=N " or Vendor-ID = 9 (CISCO) Vendor-Type = 1 (CISCO-AVPAIR) Vendor-Data = " shell:priv-lvl=N " where N is a privilege level (from 0 to 14). Note: If you set the privilege level of a login account differently on the RADIUS servers and the Switch, the user is assigned a privilege level from the database (RADIUS or local) the Switch uses first for user authentication.

53.4.1.1 Tunnel Protocol Attribute

You can configure tunnel protocol attributes on the RADIUS server (refer to your RADIUS server documentation) to assign a port on the Switch to a VLAN. The port VLAN settings are fixed and untagged. This will also set the port's VID. The following table describes the values you need to configure. Note that the bolded values in the table are fixed values as defined in RFC 3580.

Table 163 Supported Tunnel Protocol Attribute

FUNCTION	ATTRIBUTE
VLAN Assignment	Tunnel-Type = VLAN(13) Tunnel-Medium-Type = 802(6) Tunnel-Private-Group-ID = VLAN ID Note: You must also create a VLAN with the specified VID on the Switch. Note: The bolded values in this table are fixed values as defined in RFC 3580.

53.4.2 Supported RADIUS Attributes

Remote Authentication Dial-In User Service (RADIUS) attributes are data used to define specific authentication elements in a user profile, which is stored on the RADIUS server. This section lists the RADIUS attributes supported by the Switch.

Refer to RFC 2865 for more information about RADIUS attributes used for authentication.

This section lists the attributes used by authentication functions on the Switch. In cases where the

attribute has a specific format associated with it, the format is specified.

53.4.3 Attributes Used for Authentication

The following sections list the attributes sent from the Switch to the RADIUS server when performing authentication.

53.4.3.1 Attributes Used for Authenticating Privilege Access

User-Name

- The format of the User-Name attribute is **\$enab#\$**, where # is the privilege level (1 – 14).

User-Password

NAS-Identifier

NAS-IP-Address

53.4.3.2 Attributes Used to Login Users

User-Name

User-Password

NAS-Identifier

NAS-IP-Address

CHAPTER 54

Access Control

54.1 Access Control Overview

This chapter describes how to control access to the Switch.

A console port and FTP are allowed one session each, Telnet and SSH share nine sessions, up to five web sessions (five different user names and passwords) and/or limitless SNMP access control sessions are allowed.

Table 164 Access Control Overview

Console Port	SSH	Telnet	FTP	Web	SNMP
One session	Share up to 9 sessions		One session	Up to 5 accounts	No limit

A console port access control session and Telnet access control session cannot coexist when multi-login is disabled. See the CLI Reference Guide for more information on disabling multi-login.

54.1.1 What You Can Do

- Use the **Service Access Control** screen ([Section 54.2 on page 304](#)) to decide what services you may use to access the Switch.
- Use the **Remote Management** screen ([Section 54.4 on page 307](#)) to specify a group of one or more “trusted computers” from which an administrator may use a service to manage the Switch.
- Use the **Account Security** screen ([Section 54.5 on page 308](#)) to encrypt all passwords configured in the Switch. You can also display the authentication, authorization, external authentication server information (RADIUS), system and SNMP user account information in the configuration file saved.

54.2 Service Access Control

Service Access Control allows you to decide what services you may use to access the Switch. You may also change the default service port and configure “trusted computers” for each service in the **SECURITY > Access Control > Remote Management** screen (see [Section 54.4 on page 307](#) for more information). Click **SECURITY > Access Control > Service Access Control** to display the following screen.

Figure 218 SECURITY > Access Control > Service Access Control

Services	Active	Service Port	Timeout	Login Timeout
Console			5 Minutes	
Telnet	<input type="radio"/> OFF	23	5 Minutes	150 Seconds
SSH	<input checked="" type="radio"/> ON	22		
FTP	<input checked="" type="radio"/> ON	21	5 Minutes	
HTTP	<input checked="" type="radio"/> ON	80	5 Minutes	<input checked="" type="checkbox"/> Redirect to HTTPS
HTTPS	<input checked="" type="radio"/> ON	443		
ICMP	<input checked="" type="radio"/> ON			
SNMP	<input type="radio"/> OFF			

The following table describes the fields in this screen.

Table 165 SECURITY > Access Control > Service Access Control

LABEL	DESCRIPTION
Services	Services you may use to access the Switch are listed here.
Active	Enable the switch button for the corresponding services that you want to allow to access the Switch.
Service Port	For Telnet, SSH, FTP, HTTP or HTTPS services, you may change the default service port by typing the new port number in the Service Port field. If you change the default port number then you will have to let people (who wish to use the service) know the new port number for that service.
Timeout	Enter how many minutes (from 1 to 255) a management session can be left idle before the session times out. After it times out you have to log in with your password again. Very long idle timeouts may have security risks.
Login Timeout	<p>The Telnet or SSH server do not allow multiple user logins at the same time. Enter how many seconds (from 30 to 300 seconds) a login session times out. After it times out you have to start the login session again. Very long login session timeouts may have security risks.</p> <p>For example, if User A attempts to connect to the Switch (through SSH), but during the login stage, do not enter the user name and/or password, User B cannot connect to the Switch (through SSH) before the Login Timeout for User A expires (default 150 seconds).</p>
Redirect to HTTPS	This option allows your web browser to automatically redirect to a secure page, from HTTP to HTTPS (secure hypertext transfer protocol). SSL (Secure Sockets Layer) in HTTPS encrypts the transferred data by changing plain text to random letters and numbers.
Apply	Click Apply to save your changes to the Switch's run-time memory. The Switch loses these changes if it is turned off or loses power, so use the Save link on the top navigation panel to save your changes to the non-volatile memory when you are done configuring.
Cancel	Click Cancel to begin configuring this screen afresh.

54.3 Remote Management (IPv4)

Use this screen to specify a group of one or more “trusted computers using IPv4 addresses” from which an administrator may use a service to manage the Switch.

Click **SECURITY > Access Control > Remote Management IPv4** to view the screen as shown next.

Figure 219 SECURITY > Access Control > Remote Management IPv4

Remote Management IPv4
Remote Management IPv6

Secured Client Setup

Entry	Active	Start Address	End Address	Telnet	FTP	HTTP	ICMP	SNMP	SSH	HTTPS
1	<input checked="" type="radio"/>	0.0.0.0	0.0.0.0	<input checked="" type="checkbox"/>	<input checked="" type="checkbox"/>	<input checked="" type="checkbox"/>	<input checked="" type="checkbox"/>	<input checked="" type="checkbox"/>	<input checked="" type="checkbox"/>	<input checked="" type="checkbox"/>
2	<input type="radio"/>	0.0.0.0	0.0.0.0	<input type="checkbox"/>	<input type="checkbox"/>	<input type="checkbox"/>	<input type="checkbox"/>	<input type="checkbox"/>	<input type="checkbox"/>	<input type="checkbox"/>
3	<input type="radio"/>	0.0.0.0	0.0.0.0	<input type="checkbox"/>	<input type="checkbox"/>	<input type="checkbox"/>	<input type="checkbox"/>	<input type="checkbox"/>	<input type="checkbox"/>	<input type="checkbox"/>
4	<input type="radio"/>	0.0.0.0	0.0.0.0	<input type="checkbox"/>	<input type="checkbox"/>	<input type="checkbox"/>	<input type="checkbox"/>	<input type="checkbox"/>	<input type="checkbox"/>	<input type="checkbox"/>
5	<input type="radio"/>	0.0.0.0	0.0.0.0	<input type="checkbox"/>	<input type="checkbox"/>	<input type="checkbox"/>	<input type="checkbox"/>	<input type="checkbox"/>	<input type="checkbox"/>	<input type="checkbox"/>
6	<input type="radio"/>	0.0.0.0	0.0.0.0	<input type="checkbox"/>	<input type="checkbox"/>	<input type="checkbox"/>	<input type="checkbox"/>	<input type="checkbox"/>	<input type="checkbox"/>	<input type="checkbox"/>
7	<input type="radio"/>	0.0.0.0	0.0.0.0	<input type="checkbox"/>	<input type="checkbox"/>	<input type="checkbox"/>	<input type="checkbox"/>	<input type="checkbox"/>	<input type="checkbox"/>	<input type="checkbox"/>
8	<input type="radio"/>	0.0.0.0	0.0.0.0	<input type="checkbox"/>	<input type="checkbox"/>	<input type="checkbox"/>	<input type="checkbox"/>	<input type="checkbox"/>	<input type="checkbox"/>	<input type="checkbox"/>
9	<input type="radio"/>	0.0.0.0	0.0.0.0	<input type="checkbox"/>	<input type="checkbox"/>	<input type="checkbox"/>	<input type="checkbox"/>	<input type="checkbox"/>	<input type="checkbox"/>	<input type="checkbox"/>
10	<input type="radio"/>	0.0.0.0	0.0.0.0	<input type="checkbox"/>	<input type="checkbox"/>	<input type="checkbox"/>	<input type="checkbox"/>	<input type="checkbox"/>	<input type="checkbox"/>	<input type="checkbox"/>
11	<input type="radio"/>	0.0.0.0	0.0.0.0	<input type="checkbox"/>	<input type="checkbox"/>	<input type="checkbox"/>	<input type="checkbox"/>	<input type="checkbox"/>	<input type="checkbox"/>	<input type="checkbox"/>
12	<input type="radio"/>	0.0.0.0	0.0.0.0	<input type="checkbox"/>	<input type="checkbox"/>	<input type="checkbox"/>	<input type="checkbox"/>	<input type="checkbox"/>	<input type="checkbox"/>	<input type="checkbox"/>
13	<input type="radio"/>	0.0.0.0	0.0.0.0	<input type="checkbox"/>	<input type="checkbox"/>	<input type="checkbox"/>	<input type="checkbox"/>	<input type="checkbox"/>	<input type="checkbox"/>	<input type="checkbox"/>
14	<input type="radio"/>	0.0.0.0	0.0.0.0	<input type="checkbox"/>	<input type="checkbox"/>	<input type="checkbox"/>	<input type="checkbox"/>	<input type="checkbox"/>	<input type="checkbox"/>	<input type="checkbox"/>
15	<input type="radio"/>	0.0.0.0	0.0.0.0	<input type="checkbox"/>	<input type="checkbox"/>	<input type="checkbox"/>	<input type="checkbox"/>	<input type="checkbox"/>	<input type="checkbox"/>	<input type="checkbox"/>
16	<input type="radio"/>	0.0.0.0	0.0.0.0	<input type="checkbox"/>	<input type="checkbox"/>	<input type="checkbox"/>	<input type="checkbox"/>	<input type="checkbox"/>	<input type="checkbox"/>	<input type="checkbox"/>

The following table describes the labels in this screen.

Table 166 SECURITY > Access Control > Remote Management IPv4

LABEL	DESCRIPTION
Entry	This is the client set index number. A “client set” is a group of one or more “trusted computers” from which an administrator may use a service to manage the Switch.
Active	Enable the switch button to activate this secured client set. Clear the checkbox if you wish to temporarily disable the set without deleting it.
Start Address	Configure the IPv4 address range of trusted computers from which you can manage this Switch.
End Address	The Switch checks if the client IPv4 address of a computer requesting a service or protocol matches the range set here. The Switch immediately disconnects the session if it does not match.

Table 166 SECURITY > Access Control > Remote Management IPv4 (continued)

LABEL	DESCRIPTION
Telnet / FTP / HTTP / ICMP / SNMP / SSH / HTTPS	Select services that may be used for managing the Switch from the specified trusted computers.
Apply	Click Apply to save your changes to the Switch's run-time memory. The Switch loses these changes if it is turned off or loses power, so use the Save link on the top navigation panel to save your changes to the non-volatile memory when you are done configuring.
Cancel	Click Cancel to begin configuring this screen afresh.

54.4 Remote Management (IPv6)

Use this screen to specify a group of one or more "trusted computers using IPv6 addresses" from which an administrator may use a service to manage the Switch.

Click **SECURITY > Access Control > Remote Management IPv6** to view the screen as shown next.

Figure 220 SECURITY > Access Control > Remote Management IPv6

Remote Management IPv4
Remote Management IPv6

Secured Client Setup

Entry	Active	Start Address	End Address	Telnet	FTP	HTTP	ICMP	SNMP	SSH	HTTPS
1	<input checked="" type="radio"/>	::	::	<input checked="" type="checkbox"/>	<input checked="" type="checkbox"/>	<input checked="" type="checkbox"/>	<input checked="" type="checkbox"/>	<input checked="" type="checkbox"/>	<input checked="" type="checkbox"/>	<input checked="" type="checkbox"/>
2	<input type="radio"/>	::	::	<input type="checkbox"/>	<input type="checkbox"/>	<input type="checkbox"/>	<input type="checkbox"/>	<input type="checkbox"/>	<input type="checkbox"/>	<input type="checkbox"/>
3	<input type="radio"/>	::	::	<input type="checkbox"/>	<input type="checkbox"/>	<input type="checkbox"/>	<input type="checkbox"/>	<input type="checkbox"/>	<input type="checkbox"/>	<input type="checkbox"/>
4	<input type="radio"/>	::	::	<input type="checkbox"/>	<input type="checkbox"/>	<input type="checkbox"/>	<input type="checkbox"/>	<input type="checkbox"/>	<input type="checkbox"/>	<input type="checkbox"/>
5	<input type="radio"/>	::	::	<input type="checkbox"/>	<input type="checkbox"/>	<input type="checkbox"/>	<input type="checkbox"/>	<input type="checkbox"/>	<input type="checkbox"/>	<input type="checkbox"/>
6	<input type="radio"/>	::	::	<input type="checkbox"/>	<input type="checkbox"/>	<input type="checkbox"/>	<input type="checkbox"/>	<input type="checkbox"/>	<input type="checkbox"/>	<input type="checkbox"/>
7	<input type="radio"/>	::	::	<input type="checkbox"/>	<input type="checkbox"/>	<input type="checkbox"/>	<input type="checkbox"/>	<input type="checkbox"/>	<input type="checkbox"/>	<input type="checkbox"/>
8	<input type="radio"/>	::	::	<input type="checkbox"/>	<input type="checkbox"/>	<input type="checkbox"/>	<input type="checkbox"/>	<input type="checkbox"/>	<input type="checkbox"/>	<input type="checkbox"/>
9	<input type="radio"/>	::	::	<input type="checkbox"/>	<input type="checkbox"/>	<input type="checkbox"/>	<input type="checkbox"/>	<input type="checkbox"/>	<input type="checkbox"/>	<input type="checkbox"/>
10	<input type="radio"/>	::	::	<input type="checkbox"/>	<input type="checkbox"/>	<input type="checkbox"/>	<input type="checkbox"/>	<input type="checkbox"/>	<input type="checkbox"/>	<input type="checkbox"/>
11	<input type="radio"/>	::	::	<input type="checkbox"/>	<input type="checkbox"/>	<input type="checkbox"/>	<input type="checkbox"/>	<input type="checkbox"/>	<input type="checkbox"/>	<input type="checkbox"/>
12	<input type="radio"/>	::	::	<input type="checkbox"/>	<input type="checkbox"/>	<input type="checkbox"/>	<input type="checkbox"/>	<input type="checkbox"/>	<input type="checkbox"/>	<input type="checkbox"/>
13	<input type="radio"/>	::	::	<input type="checkbox"/>	<input type="checkbox"/>	<input type="checkbox"/>	<input type="checkbox"/>	<input type="checkbox"/>	<input type="checkbox"/>	<input type="checkbox"/>
14	<input type="radio"/>	::	::	<input type="checkbox"/>	<input type="checkbox"/>	<input type="checkbox"/>	<input type="checkbox"/>	<input type="checkbox"/>	<input type="checkbox"/>	<input type="checkbox"/>
15	<input type="radio"/>	::	::	<input type="checkbox"/>	<input type="checkbox"/>	<input type="checkbox"/>	<input type="checkbox"/>	<input type="checkbox"/>	<input type="checkbox"/>	<input type="checkbox"/>
16	<input type="radio"/>	::	::	<input type="checkbox"/>	<input type="checkbox"/>	<input type="checkbox"/>	<input type="checkbox"/>	<input type="checkbox"/>	<input type="checkbox"/>	<input type="checkbox"/>

The following table describes the labels in this screen.

Table 167 SECURITY > Access Control > Remote Management IPv6

LABEL	DESCRIPTION
Entry	This is the client set index number. A "client set" is a group of one or more "trusted computers" from which an administrator may use a service to manage the Switch.
Active	Enable the switch button to activate this secured client set. Clear the checkbox if you wish to temporarily disable the set without deleting it.
Start Address	Configure the IPv6 address range of trusted computers from which you can manage this Switch.
End Address	The Switch checks if the client IPv6 address of a computer requesting a service or protocol matches the range set here. The Switch immediately disconnects the session if it does not match.
Telnet / FTP / HTTP / ICMP / SNMP / SSH / HTTPS	Select services that may be used for managing the Switch from the specified trusted computers.
Apply	Click Apply to save your changes to the Switch's run-time memory. The Switch loses these changes if it is turned off or loses power, so use the Save link on the top navigation panel to save your changes to the non-volatile memory when you are done configuring.
Cancel	Click Cancel to begin configuring this screen afresh.

54.5 Account Security

Use this screen to encrypt all passwords configured in the Switch. This setting will affect how the password is shown (as plain text or encrypted text) in the configuration file saved in **MAINTENANCE > Configuration > Save Configuration**.

Note: Make sure to enable **Password Encryption** to avoid displaying passwords as plain text in the configuration file.

Note: Be careful who can access configuration files with plain text passwords!

Password Encryption encrypts all passwords in the configuration file. However, if you want to show some passwords as plain text in the configuration file, select them as below:

- **Authentication** information configured for **Authentication** in the **SECURITY > AAA > AAA Setup** screen (**Method 1/2** setting in the **Privilege Enable** and **Login** fields).
- **Authorization** information configured for **Authorization** in the **SECURITY > AAA > AAA Setup** screen (**Active/Method** setting in the **Exec** field).
- **Server** information configured for **Authentication Server** in the **SECURITY > AAA > RADIUS Server Setup** screen (**Mode/Timeout** fields).
- **System** account information configured in the Switch (admin, user login name, and password).
- **SNMP** user account information configured in the **SYSTEM > SNMP > SNMP User** screen (password for SNMP user authentication in the **Authentication** field, and the password for the encryption method for SNMP communication in the **Privacy** field).

Note: The passwords will appear as encrypted text when **Password Encryption** is **Active**.

Click **SECURITY > Access Control > Account Security** to view the screen as shown next.

Figure 221 SECURITY > Access Control > Account Security

The following table describes the labels in this screen.

Table 168 SECURITY > Access Control > Account Security

LABEL	DESCRIPTION
Account Security	
Password Encryption	Select this checkbox to encrypt all passwords configured on the Switch. This displays the password as encrypted text, in a saved configuration file. Otherwise, the passwords configured on the Switch are displayed in plain text.
Apply	Click Apply to save your changes for Account Security to the Switch's run-time memory. The Switch loses these changes if it is turned off or loses power, so use the Save link on the top navigation panel to save your changes to the non-volatile memory when you are done configuring.
Cancel	Click Cancel to begin configuring Account Security afresh.
Display	
AAA	Select which specific information to display in plain text, in the saved configuration file. <ul style="list-style-type: none"> • Authentication • Authorization • Server
User	Select which user account information to display in plain text, in the saved configuration file. <ul style="list-style-type: none"> • System • SNMP
Apply	Click Apply to save your changes for Display to the Switch's run-time memory. The Switch loses these changes if it is turned off or loses power, so use the Save link on the top navigation panel to save your changes to the non-volatile memory when you are done configuring.
Cancel	Click Cancel to begin configuring Display afresh.

54.6 Technical Reference

This section provides technical background information on the topics discussed in this chapter.

54.6.1 SSH Overview

Unlike Telnet or FTP, which transmit data in clear text, SSH (Secure Shell) is a secure communication protocol that combines authentication and data encryption to provide secure encrypted communication between two hosts over an unsecured network.

Figure 222 SSH Communication Example



54.6.1.1 How SSH Works

The following table summarizes how a secure connection is established between two remote hosts.

Figure 223 How SSH Works

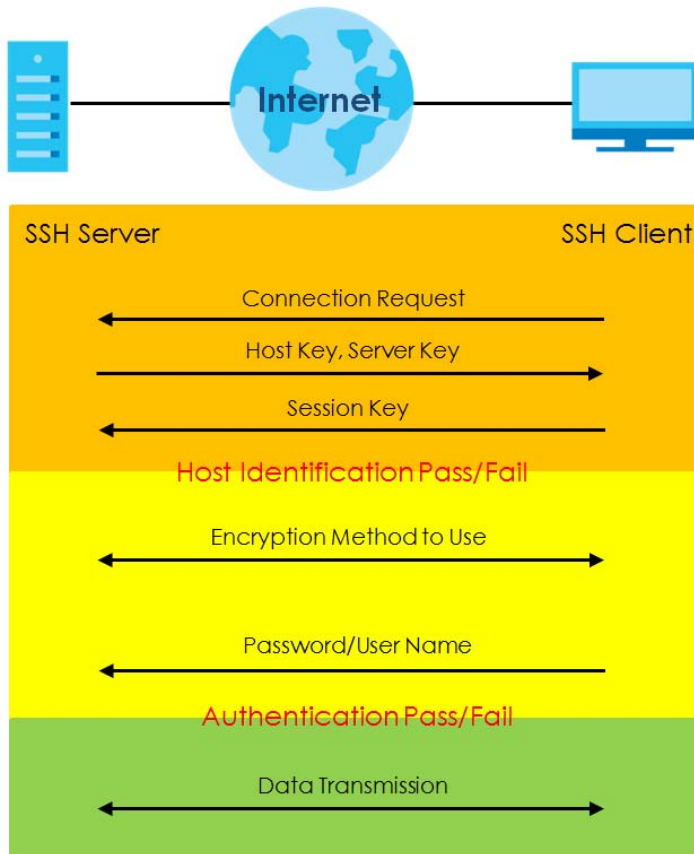

1 Host Identification

The SSH client sends a connection request to the SSH server. The server identifies itself with a host key. The client encrypts a randomly generated session key with the host key and server key and sends the result back to the server.

The client automatically saves any new server public keys. In subsequent connections, the server public key is checked against the saved version on the client computer.

2 Encryption Method

Once the identification is verified, both the client and server must agree on the type of encryption method to use.

3 Authentication and Data Transmission

After the identification is verified and data encryption activated, a secure tunnel is established between the client and the server. The client then sends its authentication information (user name and password) to the server to log in to the server.

54.6.1.2 SSH Implementation on the Switch

Your Switch supports SSH version 2 using RSA authentication and the AES encryption method. The SSH server is implemented on the Switch for remote management and file transfer on port 22. Only one SSH connection is allowed at a time.

54.6.1.3 Requirements for Using SSH

You must install an SSH client program on a client computer (Windows or Linux operating system) that is used to connect to the Switch over SSH.

54.6.2 Introduction to HTTPS

HTTPS (HyperText Transfer Protocol over Secure Socket Layer, or HTTP over SSL) is a web protocol that encrypts and decrypts web pages. Secure Socket Layer (SSL) is an application-level protocol that enables secure transactions of data by ensuring confidentiality (an unauthorized party cannot read the transferred data), authentication (one party can identify the other party) and data integrity (you know if data has been changed).

It relies upon certificates, public keys, and private keys.

HTTPS on the Switch is used so that you may securely access the Switch using the Web Configurator. The SSL protocol specifies that the SSL server (the Switch) must always authenticate itself to the SSL client (the computer which requests the HTTPS connection with the Switch), whereas the SSL client only should authenticate itself when the SSL server requires it to do so. Authenticating client certificates is optional and if selected means the SSL-client must send the Switch a certificate. You must apply for a certificate for the browser from a Certificate Authority (CA) that is a trusted CA on the Switch.

Please refer to the following figure.

- 1** HTTPS connection requests from an SSL-aware web browser go to port 443 (by default) on the Switch's WS (web server).
- 2** HTTP connection requests from a web browser go to port 80 (by default) on the Switch's WS (web server).

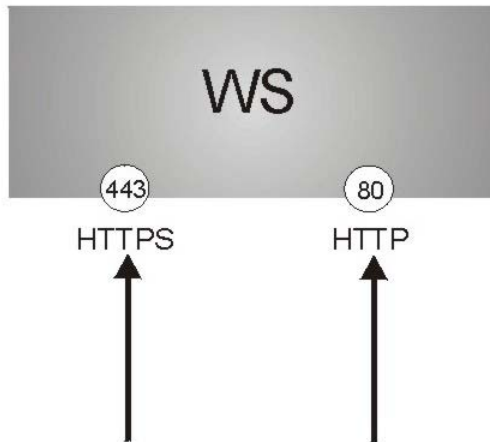
Figure 224 HTTPS Implementation

Note: If you disable HTTP in the Service Access Control screen, then the Switch blocks all HTTP connection attempts.

54.6.2.1 HTTPS Example

If you have not changed the default HTTPS port on the Switch, then in your browser enter "https://Switch IP Address/" as the web site address where "Switch IP Address" is the IP address or domain name of the Switch you wish to access.

Mozilla Firefox Warning Messages

When you attempt to access the Switch HTTPS server, a **Your connection is not secure** screen may display. If that is the case, click **I Understand the Risks** and then the **Add Exception...** button.

Figure 225 Security Alert (Mozilla Firefox)

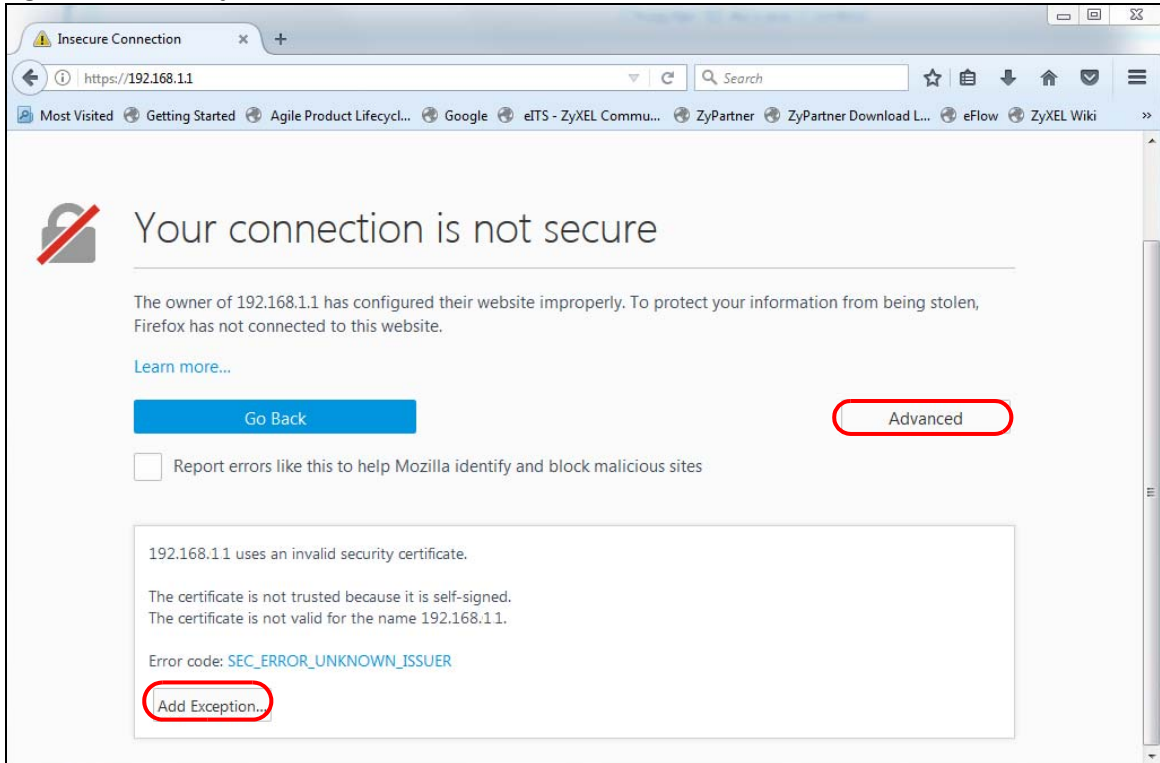

Confirm the HTTPS server URL matches. Click **Confirm Security Exception** to proceed to the Web Configurator login screen.

Figure 226 Security Alert (Mozilla Firefox)

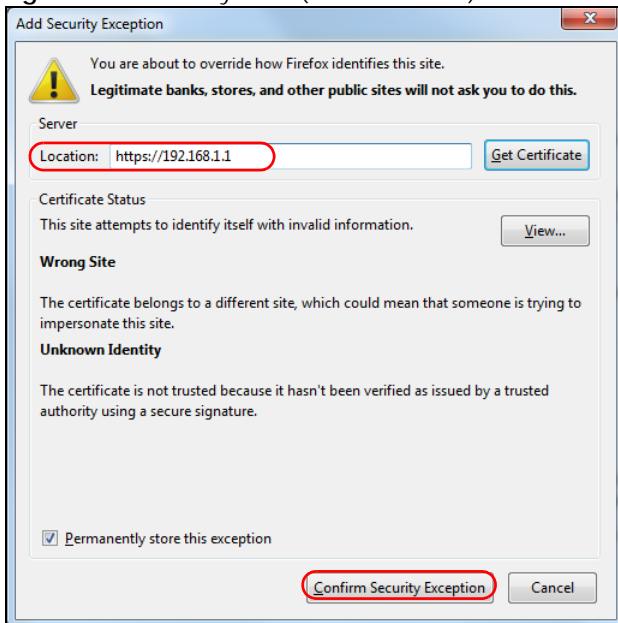

54.6.3 Google Chrome Warning Messages

When you attempt to access the Switch HTTPS server, a **Your connection is not private** screen may

display. If that is the case, click **Advanced** and then **Proceed to x.x.x.x (unsafe)** to proceed to the Web Configurator login screen.

Figure 227 Security Alert (Google Chrome 99.0.4844.82)

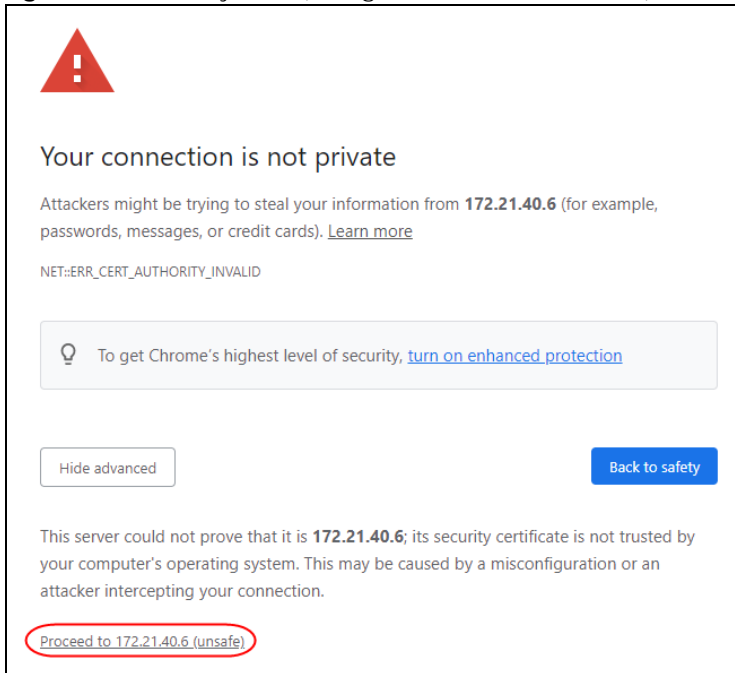

54.6.3.1 Main Settings

After you accept the certificate and enter the login user name and password, the Switch main screen appears. The lock displayed in the bottom right of the browser status bar or next to the website address denotes a secure connection.

Figure 228 Example: Lock Denoting a Secure Connection

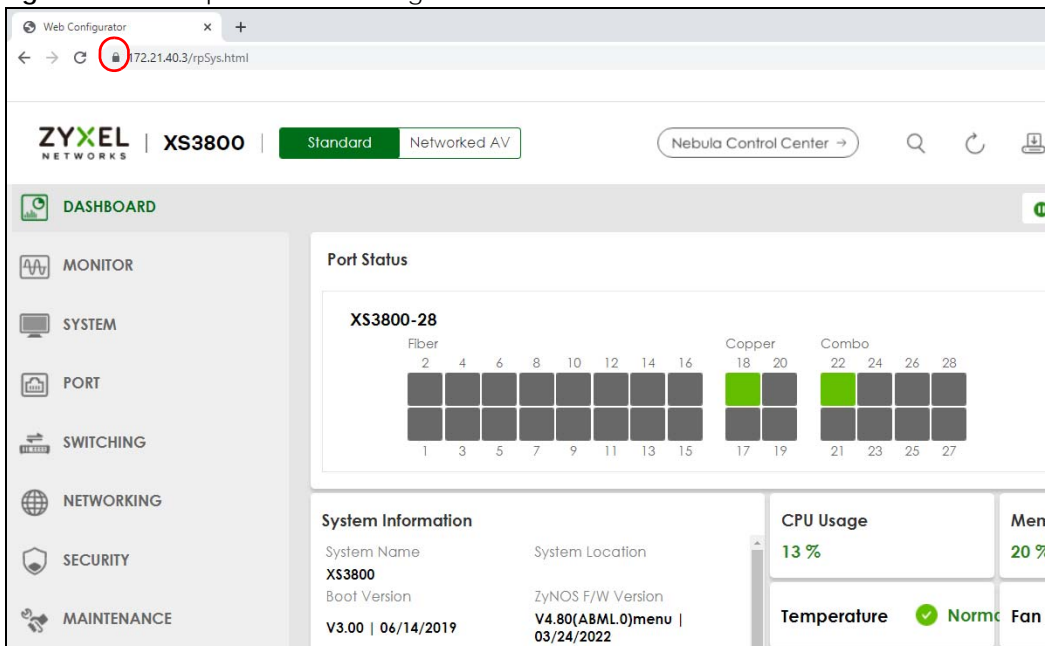

CHAPTER 55

Storm Control

55.1 Storm Control Overview

This chapter introduces and shows you how to configure the storm control feature.

Storm control limits the number of broadcast, multicast and destination lookup failure (DLF) packets the Switch receives per second on the ports. When the maximum number of allowable broadcast, multicast and/or DLF packets is reached per second, the subsequent packets are discarded. Enable this feature to reduce broadcast, multicast and/or DLF packets in your network. You can specify limits for each packet type on each port.

55.1.1 What You Can Do

Use the **Storm Control** screen ([Section 55.2 on page 315](#)) to limit the number of broadcast, multicast and destination lookup failure (DLF) packets the Switch receives per second on the ports.

55.2 Storm Control Setup

Click **SECURITY > Storm Control** in the navigation panel to display the screen as shown next.

Figure 229 SECURITY > Storm Control

Storm Control

Active OFF

Port	Broadcast (pkt/s)	Multicast (pkt/s)	DLF (pkt/s)
*	<input type="checkbox"/> <input type="text"/>	<input type="checkbox"/> <input type="text"/>	<input type="checkbox"/> <input type="text"/>
1	<input type="checkbox"/> 0 <input type="text"/>	<input type="checkbox"/> 0 <input type="text"/>	<input type="checkbox"/> 0 <input type="text"/>
2	<input type="checkbox"/> 0 <input type="text"/>	<input type="checkbox"/> 0 <input type="text"/>	<input type="checkbox"/> 0 <input type="text"/>
3	<input type="checkbox"/> 0 <input type="text"/>	<input type="checkbox"/> 0 <input type="text"/>	<input type="checkbox"/> 0 <input type="text"/>
4	<input type="checkbox"/> 0 <input type="text"/>	<input type="checkbox"/> 0 <input type="text"/>	<input type="checkbox"/> 0 <input type="text"/>
5	<input type="checkbox"/> 0 <input type="text"/>	<input type="checkbox"/> 0 <input type="text"/>	<input type="checkbox"/> 0 <input type="text"/>
6	<input type="checkbox"/> 0 <input type="text"/>	<input type="checkbox"/> 0 <input type="text"/>	<input type="checkbox"/> 0 <input type="text"/>
7	<input type="checkbox"/> 0 <input type="text"/>	<input type="checkbox"/> 0 <input type="text"/>	<input type="checkbox"/> 0 <input type="text"/>

Apply Cancel

The following table describes the labels in this screen.

Table 169 SECURITY > Storm Control

LABEL	DESCRIPTION
Active	Enable the switch button to enable traffic storm control on the Switch. Disable the switch button to disable this feature.
Port	This field displays the port number.
*	Settings in this row apply to all ports. Use this row only if you want to make some settings the same for all ports. Use this row first to set the common settings and then make adjustments on a port-by-port basis. Note: Changes in this row are copied to all the ports as soon as you make them.
Broadcast (pkt/s)	Select this option and specify how many broadcast packets the port receives per second.
Multicast (pkt/s)	Select this option and specify how many multicast packets the port receives per second.
DLF (pkt/s)	Select this option and specify how many destination lookup failure (DLF) packets the port receives per second.
Apply	Click Apply to save your changes to the Switch's run-time memory. The Switch loses these changes if it is turned off or loses power, so use the Save link on the top navigation panel to save your changes to the non-volatile memory when you are done configuring.
Cancel	Click Cancel to reset the fields.

CHAPTER 56

Error-Disable

56.1 Error-Disable Overview

This chapter shows you how to configure the rate limit for control packets on a port, and set the Switch to take an action (such as to shut down a port or stop sending packets) on a port when the Switch detects a pre-configured error. It also shows you how to configure the Switch to automatically undo the action after the error is gone.

56.1.1 CPU Protection Overview

Switches exchange protocol control packets in a network to get the latest networking information. If a switch receives large numbers of control packets, such as ARP, BPDU or IGMP packets, which are to be processed by the CPU, the CPU may become overloaded and be unable to handle regular tasks properly.

The CPU protection feature allows you to limit the rate of ARP, BPDU and IGMP packets to be delivered to the CPU on a port. This enhances the CPU efficiency and protects against potential DoS attacks or errors from other networks. You then can choose to drop control packets that exceed the specified rate limit or disable a port on which the packets are received.

56.1.2 Error-Disable Recovery Overview

Some features, such as loop guard or CPU protection, allow the Switch to shut down a port or discard specific packets on a port when an error is detected on the port. For example, if the Switch detects that packets sent out the ports loop back to the Switch, the Switch can shut down the ports automatically. After that, you need to enable the ports or allow the packets on a port manually through the Web Configurator or the commands. With error-disable recovery, you can set the disabled ports to become active or start receiving the packets again after the time interval you specify.

56.1.3 What You Can Do

- Use the **Errdisable Status** screen ([Section 56.2 on page 318](#)) to view whether the Switch detected that control packets exceeded the rate limit configured for a port or a port is disabled according to the feature requirements and what action you configure, and related information.
- Use the **CPU Protection** screen ([Section 56.3 on page 319](#)) to limit the maximum number of control packets (ARP, BPDU and/or IGMP) that the Switch can receive or transmit on a port.
- Use the **Errdisable Detect** screen ([Section 56.4 on page 320](#)) to have the Switch detect whether the control packets exceed the rate limit configured for a port and configure the action to take once the limit is exceeded.
- Use the **Errdisable Recovery** screen ([Section 56.5 on page 321](#)) to set the Switch to automatically undo an action after the error is gone.

56.2 Error-Disable Status

Use this screen to view whether the Switch detected that control packets exceeded the rate limit configured for a port or a port is disabled according to the feature requirements and what action you configure, and related information. Click **SECURITY > Errdisable > Errdisable Status** to display the screen as shown.

Figure 230 SECURITY > Errdisable > Errdisable Status

Port	Cause	Active	Mode	Rate	Status	Recovery Time Left (secs)	Total Dropped
1	Loop Guard	OFF	inactive-port	-	Forwarding	-	-
	ARP	OFF	inactive-port	0	Forwarding	-	-
	BPDU	OFF	inactive-port	0	Forwarding	-	-
	IGMP	OFF	inactive-port	0	Forwarding	-	-
2	Loop Guard	OFF	inactive-port	-	Forwarding	-	-
	ARP	OFF	inactive-port	0	Forwarding	-	-
	BPDU	OFF	inactive-port	0	Forwarding	-	-
	IGMP	OFF	inactive-port	0	Forwarding	-	-
3	Loop Guard	OFF	inactive-port	-	Forwarding	-	-
	ARP	OFF	inactive-port	0	Forwarding	-	-
	BPDU	OFF	inactive-port	0	Forwarding	-	-
	IGMP	OFF	inactive-port	0	Forwarding	-	-
4	Loop Guard	OFF	inactive-port	-	Forwarding	-	-
	ARP	OFF	inactive-port	0	Forwarding	-	-
	BPDU	OFF	inactive-port	0	Forwarding	-	-
	IGMP	OFF	inactive-port	0	Forwarding	-	-
5	Loop Guard	OFF	inactive-port	-	Forwarding	-	-
	ARP	OFF	inactive-port	0	Forwarding	-	-

The following table describes the labels in this screen.

Table 170 SECURITY > Errdisable > Errdisable Status

LABEL	DESCRIPTION
Inactive-reason mode reset	
Port	Enter the number of the ports (separated by a comma) on which you want to reset inactive-reason status.
Cause	Select the cause of inactive-reason mode you want to reset here.
Reset	Click to reset the specified ports to handle ARP, BPDU or IGMP packets instead of ignoring them, if the ports is in inactive-reason mode.
Errdisable Status	
Port	This is the number of the port on which you want to configure Errdisable Status.
Cause	This displays the type of the control packet received on the port or the feature enabled on the port and causing the Switch to take the specified action.
Active	This field displays whether the control packets (ARP, BPDU, and/or IGMP) on the port is being detected or not. It also shows whether loop guard, anti-arp scanning, BPDU guard or ZULD is enabled on the port.

Table 170 SECURITY > Errdisable > Errdisable Status (continued)

LABEL	DESCRIPTION
Mode	This field shows the action that the Switch takes for the cause. <ul style="list-style-type: none"> inactive-port – The Switch disables the port. inactive-reason – The Switch drops all the specified control packets (such as BPDU) on the port. rate-limitation – The Switch drops the additional control packets the ports has to handle in every one second.
Rate	This field displays how many control packets this port can receive or transmit per second. It can be adjusted in CPU Protection . 0 means no rate limit.
Status	This field displays the errdisable status. <ul style="list-style-type: none"> Forwarding: The Switch is forwarding packets. Rate-limitation mode is always in Forwarding status. Err-disable: The Switch disables the port on which the control packets are received (inactive-port) or drops specified control packets on the port (inactive-reason).
Recovery Time Left (secs)	This field displays the time (seconds) left before the ports becomes active of Errdisable Recovery.
Total Dropped	This field displays the total packet number dropped by this port where the packet rate exceeds the rate of mode rate-limitation.

56.3 CPU Protection Setup

Use this screen to limit the maximum number of control packets (ARP, BPDU and/or IGMP) that the Switch can receive or transmit on a port. Click **SECURITY > Errdisable > CPU Protection** to display the screen as shown.

Note: After you configure this screen, make sure you also enable error detection for the specific control packets in the **SECURITY > Errdisable > Errdisable Detect** screen.

Figure 231 SECURITY > Errdisable > CPU Protection

Errdisable Status **CPU Protection** Errdisable Detect Errdisable Recovery

Reason

Port	Rate Limit (pkt/s)
*	<input type="text"/>
1	<input type="text" value="0"/>
2	<input type="text" value="0"/>
3	<input type="text" value="0"/>
4	<input type="text" value="0"/>
5	<input type="text" value="0"/>
6	<input type="text" value="0"/>
7	<input type="text" value="0"/>
8	<input type="text" value="0"/>

The following table describes the labels in this screen.

Table 171 SECURITY > Errdisable > CPU Protection

LABEL	DESCRIPTION
Reason	Select the type of control packet you want to configure here.
Port	This field displays the port number.
*	Use this row to make the setting the same for all ports. Use this row first and then make adjustments to each port if necessary. Changes in this row are copied to all the ports as soon as you make them.
Rate Limit (pkt/s)	Enter a number from 0 to 256 to specify how many control packets this port can receive or transmit per second. 0 means no rate limit. You can configure the action that the Switch takes when the limit is exceeded.
Apply	Click Apply to save your changes to the Switch's run-time memory. The Switch loses these changes if it is turned off or loses power, so use the Save link on the top navigation panel to save your changes to the non-volatile memory when you are done configuring.
Cancel	Click Cancel to begin configuring this screen afresh.

56.4 Error-Disable Detect Setup

Use this screen to have the Switch detect whether the control packets exceed the rate limit configured for a port and configure the action to take once the limit is exceeded. Click **SECURITY > Errdisable > Errdisable Detect** to display the screen as shown.

Figure 232 SECURITY > Errdisable > Errdisable Detect

Cause	Active	Mode
*	<input type="checkbox"/>	inactive-port ▼
ARP	<input type="checkbox"/>	inactive-port ▼
BPDU	<input type="checkbox"/>	inactive-port ▼
IGMP	<input type="checkbox"/>	inactive-port ▼

The following table describes the labels in this screen.

Table 172 SECURITY > Errdisable > Errdisable Detect

LABEL	DESCRIPTION
Cause	This field displays the types of control packet that may cause CPU overload.
*	Use this row to make the setting the same for all entries. Use this row first and then make adjustments to each entry if necessary. Changes in this row are copied to all the entries as soon as you make them.
Active	Select this option to have the Switch detect if the configured rate limit for a specific control packet is exceeded and take the action selected below.

Table 172 SECURITY > Errdisable > Errdisable Detect (continued)

LABEL	DESCRIPTION
Mode	Select the action that the Switch takes when the number of control packets exceed the rate limit on a port, set in the SECURITY > Errdisable > CPU Protection screen. <ul style="list-style-type: none"> inactive-port – The Switch disables the port on which the control packets are received. inactive-reason – The Switch drops all the specified control packets (such as BPDU) on the port. rate-limitation – The Switch drops the additional control packets the ports has to handle in every one second.
Apply	Click Apply to save your changes to the Switch's run-time memory. The Switch loses these changes if it is turned off or loses power, so use the Save link on the top navigation panel to save your changes to the non-volatile memory when you are done configuring.
Cancel	Click Cancel to begin configuring this screen afresh.

56.5 Error-Disable Recovery Setup

Use this screen to configure the Switch to automatically undo an action after the error is gone. Click **SECURITY > Errdisable > Errdisable Recovery** to display the screen as shown.

Figure 233 SECURITY > Errdisable > Errdisable Recovery

Reason	Time Status	Interval
*	<input type="checkbox"/>	<input type="text"/>
loopguard	<input type="checkbox"/>	<input type="text" value="300"/>
ARP	<input type="checkbox"/>	<input type="text" value="300"/>
BPDU	<input type="checkbox"/>	<input type="text" value="300"/>
IGMP	<input type="checkbox"/>	<input type="text" value="300"/>

The following table describes the labels in this screen.

Table 173 SECURITY > Errdisable > Errdisable Recovery

LABEL	DESCRIPTION
Active	Enable the switch button to turn on the error-disable recovery function on the Switch.
Reason	This field displays the supported features that allow the Switch to shut down a port or discard packets on a port according to the feature requirements and what action you configure.
*	Use this row to make the setting the same for all entries. Use this row first and then make adjustments to each entry if necessary. Changes in this row are copied to all the entries as soon as you make them.
Time Status	Select this checkbox to allow the Switch to wait for the specified time interval to activate a port or allow specific packets on a port, after the error was gone. Clear the checkbox to turn off this rule.
Interval	Enter the number of seconds (from 30 to 2592000) for the time interval.

Table 173 SECURITY > Errdisable > Errdisable Recovery (continued)

LABEL	DESCRIPTION
Apply	Click Apply to save your changes to the Switch's run-time memory. The Switch loses these changes if it is turned off or loses power, so use the Save link on the top navigation panel to save your changes to the non-volatile memory when you are done configuring.
Cancel	Click Cancel to begin configuring this screen afresh.

CHAPTER 57

DHCP Snooping

57.1 DHCP Snooping Overview

DHCP snooping filters unauthorized DHCP server packets. The Switch allows only the authorized DHCP server on a trusted port to assign IP addresses. Clients on your network will only receive DHCP packets from the authorized DHCP server.

The Switch also builds a DHCP snooping binding table dynamically by snooping DHCP packets (dynamic bindings). A DHCP snooping binding table contains the IP binding information the Switch learns from DHCP packets in your network. A binding contains these key attributes:

- MAC address
- VLAN ID
- IP address
- Port number

The following settings demonstrates DHCP snooping on the Switch.

- An authorized DHCP server (A) on a snooped VLAN from the trusted port (T)
- An unauthorized DHCP server (B) on a snooped VLAN from an untrusted port (UT)
- DHCP clients (C) on the untrusted ports (UT).

With DHCP snooping, the Switch blocks all DHCP server packets (DHCP OFFER/ACK) coming from the untrusted ports (UT). The Switch only forwards the DHCP server packets from the trusted port (T). This assures that DHCP clients on your network only receive IP addresses assigned by the authorized DHCP server (A).

Figure 234 DHCP Snooping Example Application

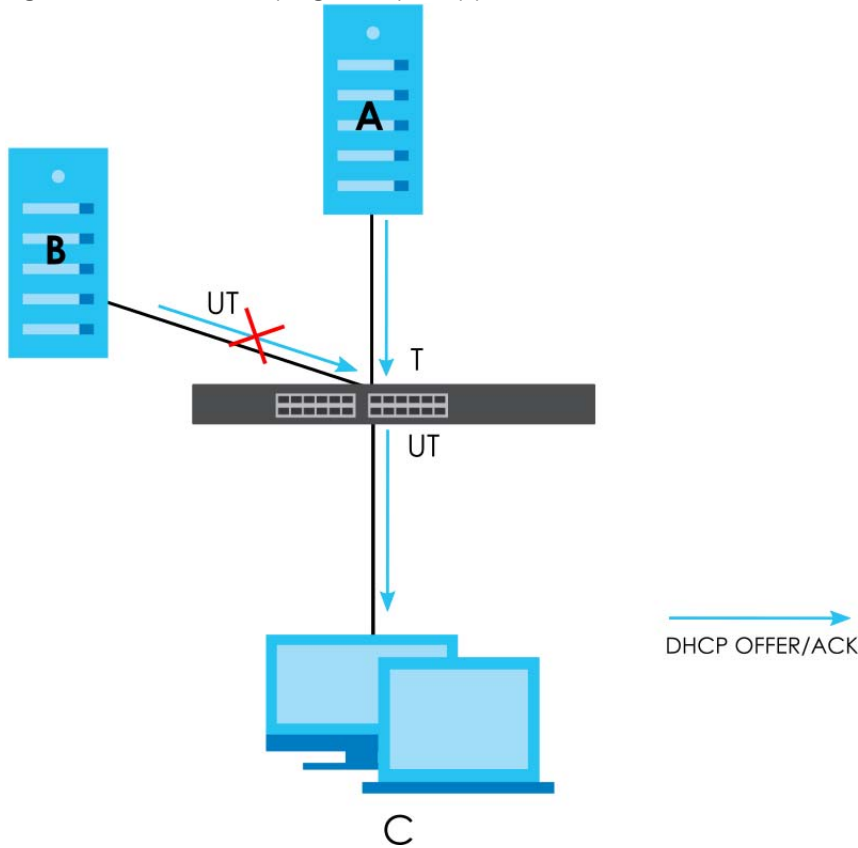

57.1.1 What You Can Do

- Use the **DHCP Snooping Status** screen ([Section 57.2 on page 324](#)) to look at various statistics about the DHCP snooping database.
- Use this **DHCP Snooping Setup** screen ([Section 57.3 on page 327](#)) to enable DHCP snooping on the Switch (not on specific VLAN), specify the VLAN where the default DHCP server is located, and configure the DHCP snooping database.
- Use the **DHCP Snooping Port Setup** screen ([Section 57.4 on page 328](#)) to specify whether ports are trusted or untrusted ports for DHCP snooping.
- Use the **DHCP Snooping VLAN Setup** screen ([Section 57.5 on page 330](#)) to enable DHCP snooping on each VLAN and to specify whether or not the Switch adds DHCP relay agent option 82 information to DHCP requests that the Switch relays to a DHCP server for each VLAN.
- Use the **DHCP Snooping VLAN Port Setup** screen ([Section 57.6 on page 331](#)) to apply a different DHCP option 82 profile to certain ports in a VLAN.

57.2 DHCP Snooping Status

Use this screen to look at various statistics about the DHCP snooping database.

To open this screen, click **SECURITY > DHCP Snooping > DHCP Snp. Status**.

Figure 235 SECURITY > DHCP Snooping > DHCP Snp. Status

DHCP Snp. Status		DHCP Snp. Setup	DHCP Snp. Port Setup	DHCP Snp. VLAN Setup	DHCP Snp. VLAN Port Setup
DHCP Snooping					
Database Status			Database Detail		
Agent URL			First Successful Access	None	
Write Delay Timer	300		Last Ignored Bindings Counters		
Abort Timer	300		Binding Collisions	0	
Agent Running	None		Invalid Interfaces	0	
Delay Timer Expiry	Not Running		Parse Failures	0	
Abort Timer Expiry	Not Running		Expired Leases	0	
Last Succeeded Time	None		Unsupported VLANs	0	
Last Failed Time	None		Last Ignored Time	None	
Last Failed Reason	No failure recorded		Total Ignored Bindings Counters		
Counters			Binding Collisions	0	
Total Attempts	0		Invalid Interfaces	0	
Startup Failures	0		Parse Failures	0	
Successful Transfers	0		Expired Leases	0	
Failed Transfers	0		Unsupported VLANs	0	
Successful Reads	0				
Failed Reads	0				
Successful Writes	0				
Failed Writes	0				

The following table describes the labels in this screen.

Table 174 SECURITY > DHCP Snooping > DHCP Snp. Status

LABEL	DESCRIPTION
Database Status	
This section displays the current settings for the DHCP snooping database. You can configure them in the SECURITY > DHCP Snooping > DHCP Snp. Setup screen.	
Agent URL	This field displays the location of the DHCP snooping database.
Write Delay Timer	This field displays how long (in seconds) the Switch tries to complete a specific update in the DHCP snooping database before it gives up.
Abort Timer	This field displays how long (in seconds) the Switch waits to update the DHCP snooping database after the current bindings change.
Agent Running	This field displays the status of the current update or access of the DHCP snooping database. None: The Switch is not accessing the DHCP snooping database. Read: The Switch is loading dynamic bindings from the DHCP snooping database. Write: The Switch is updating the DHCP snooping database.
Delay Timer Expiry	This field displays how much longer (in seconds) the Switch tries to complete the current update before it gives up. It displays Not Running if the Switch is not updating the DHCP snooping database right now.
Abort Timer Expiry	This field displays when (in seconds) the Switch is going to update the DHCP snooping database again. It displays Not Running if the current bindings have not changed since the last update.
Last Succeeded Time	This field displays the last time the Switch updated the DHCP snooping database successfully.
Last Failed Time	This field displays the last time the Switch updated the DHCP snooping database unsuccessfully.

Table 174 SECURITY > DHCP Snooping > DHCP Snp. Status (continued)

LABEL	DESCRIPTION
Last Failed Reason	This field displays the reason the Switch updated the DHCP snooping database unsuccessfully.
Counters	
This section displays historical information about the number of times the Switch successfully or unsuccessfully read or updated the DHCP snooping database.	
Total Attempts	This field displays the number of times the Switch has tried to access the DHCP snooping database for any reason.
Startup Failures	This field displays the number of times the Switch could not create or read the DHCP snooping database when the Switch started up or a new URL is configured for the DHCP snooping database.
Successful Transfers	This field displays the number of times the Switch read bindings from or updated the bindings in the DHCP snooping database successfully.
Failed Transfers	This field displays the number of times the Switch was unable to read bindings from or update the bindings in the DHCP snooping database.
Successful Reads	This field displays the number of times the Switch read bindings from the DHCP snooping database successfully.
Failed Reads	This field displays the number of times the Switch was unable to read bindings from the DHCP snooping database.
Successful Writes	This field displays the number of times the Switch updated the bindings in the DHCP snooping database successfully.
Failed Writes	This field displays the number of times the Switch was unable to update the bindings in the DHCP snooping database.
Database Detail	
First Successful Access	This field displays the first time the Switch accessed the DHCP snooping database for any reason.
Last Ignored Bindings Counters	
This section displays the number of times and the reasons the Switch ignored bindings the last time it read bindings from the DHCP binding database. You can clear these counters by restarting the Switch or using CLI commands. See the Ethernet Switch CLI Reference Guide.	
Binding Collisions	This field displays the number of bindings the Switch ignored because the Switch already had a binding with the same MAC address and VLAN ID.
Invalid Interfaces	This field displays the number of bindings the Switch ignored because the port number was a trusted interface or does not exist anymore.
Parse Failures	This field displays the number of bindings the Switch ignored because the Switch was unable to understand the binding in the DHCP binding database.
Expired Leases	This field displays the number of bindings the Switch ignored because the lease time had already expired.
Unsupported VLANs	This field displays the number of bindings the Switch ignored because the VLAN ID does not exist anymore.
Last Ignored Time	This field displays the last time the Switch ignored any bindings for any reason from the DHCP binding database.
Total Ignored Bindings Counters	
This section displays the reasons the Switch has ignored bindings any time it read bindings from the DHCP binding database. You can clear these counters by restarting the Switch or using CLI commands. See the Ethernet Switch CLI Reference Guide.	
Binding Collisions	This field displays the number of bindings the Switch has ignored because the Switch already had a binding with the same MAC address and VLAN ID.
Invalid Interfaces	This field displays the number of bindings the Switch has ignored because the port number was a trusted interface or does not exist anymore.

Table 174 SECURITY > DHCP Snooping > DHCP Snp. Status (continued)

LABEL	DESCRIPTION
Parse Failures	This field displays the number of bindings the Switch has ignored because the Switch was unable to understand the binding in the DHCP binding database.
Expired Leases	This field displays the number of bindings the Switch has ignored because the lease time had already expired.
Unsupported VLANs	This field displays the number of bindings the Switch has ignored because the VLAN ID does not exist anymore.

57.3 DHCP Snooping Setup

Use this screen to enable DHCP snooping on the Switch (not on specific VLAN), specify the VLAN where the default DHCP server is located, and configure the DHCP snooping database. The DHCP snooping database stores the current bindings on a secure, external TFTP server so that they are still available after a restart.

To open this screen, click **SECURITY > DHCP Snooping > DHCP Snp. Setup**.

Note: The input string of any field in this screen should not contain [?], [|], ['], ["], or [,].

Figure 236 SECURITY > DHCP Snooping > DHCP Snp. Setup

The following table describes the labels in this screen.

Table 175 SECURITY > DHCP Snooping > DHCP Snp. Setup

LABEL	DESCRIPTION
DHCP Snooping Setup	
Active	Enable the switch button to enable DHCP snooping on the Switch. You still have to enable DHCP snooping on specific VLAN and specify trusted ports. Note: If DHCP is enabled and there are no trusted ports, DHCP requests will not succeed.

Table 175 SECURITY > DHCP Snooping > DHCP Snp. Setup (continued)

LABEL	DESCRIPTION
DHCP VLAN	<p>Select a VLAN ID if you want the Switch to forward DHCP packets to DHCP servers on a specific VLAN.</p> <p>Note: You have to enable DHCP snooping on the DHCP VLAN too.</p> <p>You can enable Option 82 Profile in the SECURITY > DHCP Snooping > DHCP Snp. VLAN Setup screen to help the DHCP servers distinguish between DHCP requests from different VLAN.</p> <p>Select Disable if you do not want the Switch to forward DHCP packets to a specific VLAN.</p>
<p>Database</p> <p>If Timeout Interval is greater than Write Delay Interval, it is possible that the next update is scheduled to occur before the current update has finished successfully or timed out. In this case, the Switch waits to start the next update until it completes the current one.</p>	
Agent URL	<p>Enter the location of the DHCP snooping database. The location should be expressed like this: ftp://{domain name or IP address}/directory, if applicable/file name; for example, ftp://192.168.10.1/database.txt. You can enter up to 256 printable ASCII characters except [?], [] , ['], ["] or [,] .</p>
Timeout Interval	<p>Enter how long (10 – 65535 seconds) the Switch tries to complete a specific update in the DHCP snooping database before it gives up.</p>
Write Delay Interval	<p>Enter how long (10 – 65535 seconds) the Switch waits to update the DHCP snooping database the first time the current bindings change after an update. Once the next update is scheduled, additional changes in current bindings are automatically included in the next update.</p>
Renew DHCP Snooping URL	<p>Enter the location of a DHCP snooping database, and click Renew if you want the Switch to load it. You can use this to load dynamic bindings from a different DHCP snooping database than the one specified in Agent URL.</p> <p>When the Switch loads dynamic bindings from a DHCP snooping database, it does not discard the current dynamic bindings first. If there is a conflict, the Switch keeps the dynamic binding in volatile memory and updates the Binding Collisions counter in the DHCP Snooping Status screen (Section 57.2 on page 324).</p>
Apply	<p>Click Apply to save your changes to the Switch's run-time memory. The Switch loses these changes if it is turned off or loses power, so use the Save link on the top navigation panel to save your changes to the non-volatile memory when you are done configuring.</p>
Cancel	<p>Click this to reset the values in this screen to their last-saved values.</p>

57.4 DHCP Snooping Port Setup

Use this screen to specify whether ports are trusted or untrusted ports for DHCP snooping.

Note: If DHCP snooping is enabled but there are no trusted ports, DHCP requests cannot reach the DHCP server.

You can also specify the maximum number for DHCP packets that each port (trusted or untrusted) can receive each second.

To open this screen, click **SECURITY > DHCP Snooping > DHCP Snp. Port Setup**.

Figure 237 SECURITY > DHCP Snooping > DHCP Snp. Port Setup

DHCP Snp. Status			DHCP Snp. Setup			DHCP Snp. Port Setup		
Port	Server Trusted State		Rate (pps)					
*	Untrusted ▼		<input type="text"/>					
1	Untrusted ▼		<input type="text" value="0"/>					
2	Untrusted ▼		<input type="text" value="0"/>					
3	Untrusted ▼		<input type="text" value="0"/>					
4	Untrusted ▼		<input type="text" value="0"/>					
5	Untrusted ▼		<input type="text" value="0"/>					
6	Untrusted ▼		<input type="text" value="0"/>					
7	Untrusted ▼		<input type="text" value="0"/>					
	Untrusted ▼		<input type="text" value="0"/>					

The following table describes the labels in this screen.

Table 176 SECURITY > DHCP Snooping > DHCP Snp. Port Setup

LABEL	DESCRIPTION
Port	This field displays the port number.
*	<p>Settings in this row apply to all ports.</p> <p>Use this row only if you want to make some settings the same for all ports. Use this row first to set the common settings and then make adjustments on a port-by-port basis.</p> <p>Note: Changes in this row are copied to all the ports as soon as you make them.</p>
Server Trusted state	<p>Select whether this port is a trusted port (Trusted) or an untrusted port (Untrusted).</p> <p>Trusted ports are connected to DHCP servers or other switches, and the Switch discards DHCP packets from trusted ports only if the rate at which DHCP packets arrive is too high.</p> <p>Untrusted ports are connected to subscribers, and the Switch discards DHCP packets from untrusted ports in the following situations:</p> <ul style="list-style-type: none"> • The packet is a DHCP server packet (for example, OFFER, ACK, or NACK). • The source MAC address and source IP address in the packet do not match any of the current bindings. • The packet is a RELEASE or DECLINE packet, and the source MAC address and source port do not match any of the current bindings. • The rate at which DHCP packets arrive is too high.
Rate (pps)	Specify the maximum number for DHCP packets (1 – 256) that the Switch receives from each port each second. The Switch discards any additional DHCP packets. Enter 0 to disable this limit, which is recommended for trusted ports.
Apply	Click Apply to save your changes to the Switch's run-time memory. The Switch loses these changes if it is turned off or loses power, so use the Save link on the top navigation panel to save your changes to the non-volatile memory when you are done configuring.
Cancel	Click this to reset the values in this screen to their last-saved values.

57.5 DHCP Snooping VLAN Setup

Use this screen to enable DHCP snooping on each VLAN and to specify whether or not the Switch adds DHCP relay agent option 82 information to DHCP requests that the Switch relays to a DHCP server for each VLAN.

To open this screen, click **SECURITY > DHCP Snooping > DHCP Snp. VLAN Setup**.

Figure 238 SECURITY > DHCP Snooping > DHCP Snp. VLAN Setup

VID	Enabled	Option 82 Profile
*	No	
1	No	

The following table describes the labels in this screen.

Table 177 SECURITY > DHCP Snooping > DHCP Snp. VLAN Setup

LABEL	DESCRIPTION
Search VLAN by VID	Enter the VLAN ID you want to manage. Use a comma (,) to separate individual VLANs or a hyphen (-) to indicates a range of VLANs. For example, "3,4" or "3-9".
Search	Click this to display the specified range of VLANs in the section below.
The Number of VLANs	This displays the number of VLAN search results.
VID	This field displays the VLAN ID of each VLAN in the range specified above. If you configure the * VLAN, the settings are applied to all VLANs.
Enabled	Select Yes to enable DHCP snooping on the VLAN. You still have to enable DHCP snooping on the Switch and specify trusted ports. Note: The Switch will drop all DHCP requests if you enable DHCP snooping and there are no trusted ports.
Option 82 Profile	Select a pre-defined DHCP option 82 profile that the Switch applies to all ports in the specified VLANs. The Switch adds the information (such as slot number, port number, VLAN ID and/or system name) specified in the profile to DHCP requests that it broadcasts to the DHCP VLAN, if specified, or VLAN. You can specify the DHCP VLAN in the SECURITY > DHCP Snooping > DHCP Snp. Setup screen.
Apply	Click Apply to save your changes to the Switch's run-time memory. The Switch loses these changes if it is turned off or loses power, so use the Save link on the top navigation panel to save your changes to the non-volatile memory when you are done configuring.
Cancel	Click this to reset the values in this screen to their last-saved values.

57.6 DHCP Snooping VLAN Port Setup

Use this screen to apply a different DHCP option 82 profile to certain ports in a VLAN.

To open this screen, click **SECURITY > DHCP Snooping > DHCP Snp. VLAN Port Setup**.

Figure 239 SECURITY > DHCP Snooping > DHCP Snp. VLAN Port Setup

The following table describes the labels in this screen.

Table 178 SECURITY > DHCP Snooping > DHCP Snp. VLAN Port Setup

LABEL	DESCRIPTION
Index	This field displays a sequential number for each entry.
VID	This field displays the VLAN to which the ports belongs.
Port	This field displays the ports to which the Switch applies the settings.
Profile Name	This field displays the DHCP option 82 profile that the Switch applies to the ports.
Add/Edit	Click Add/Edit to add a new entry or edit a selected one.
Delete	Click Delete to remove the selected entries.

57.6.1 Add/EDIT DHCP Snooping VLAN Ports

Use this screen to apply a different DHCP option 82 profile to certain ports in a VLAN.

Click **Add/Edit**, or select an entry and click **Add/Edit** in the **SECURITY > DHCP Snooping > DHCP Snp. VLAN Port Setup** screen to display this screen.

Figure 240 SECURITY > DHCP Snooping > DHCP Snp. VLAN Port Setup > Add/Edit

The following table describes the labels in this screen.

Table 179 SECURITY > DHCP Snooping > DHCP Snp. VLAN Port Setup > Add/Edit

LABEL	DESCRIPTION
VID	Enter the ID number of the VLAN you want to configure here.
Port	Enter the number of ports to which you want to apply the specified DHCP option 82 profile. You can enter multiple ports separated by (no space) comma (,) or hyphen (-) for a range. For example, enter "3-5" for ports 3, 4, and 5. Enter "3,5,7" for ports 3, 5, and 7.
Option 82 Profile	Select a pre-defined DHCP option 82 profile that the Switch applies to the specified ports in this VLAN. The Switch adds the information (such as slot number, port number, VLAN ID and/or system name) specified in the profile to DHCP requests that it broadcasts to the DHCP VLAN, if specified, or VLAN. You can specify the DHCP VLAN in the SECURITY > DHCP Snooping > DHCP Snp. Setup screen. Note: The profile you select here has priority over the one you select in the SECURITY > DHCP Snooping > DHCP Snp. VLAN Setup screen.
Apply	Click Apply to save your changes to the Switch's run-time memory. The Switch loses these changes if it is turned off or loses power, so use the Save link on the top navigation panel to save your changes to the non-volatile memory when you are done configuring.
Clear	Click Clear to clear the fields to the factory defaults.
Cancel	Click Cancel to not save the configuration you make and return to the last screen.

57.7 Technical Reference

This section provides technical background information on the topics discussed in this chapter.

57.7.1 DHCP Snooping Overview

Use DHCP snooping to filter unauthorized DHCP packets on the network and to build the binding table dynamically. This can prevent clients from getting IP addresses from unauthorized DHCP servers.

57.7.1.1 Trusted vs. Untrusted Ports

Every port is either a trusted port or an untrusted port for DHCP snooping. This setting is independent of the trusted or untrusted setting for ARP inspection. You can also specify the maximum number for DHCP packets that each port (trusted or untrusted) can receive each second.

Trusted ports are connected to DHCP servers or other switches. The Switch discards DHCP packets from trusted ports only if the rate at which DHCP packets arrive is too high. The Switch learns dynamic bindings from trusted ports.

Note: If DHCP is enabled and there are no trusted ports, DHCP requests will not succeed.

Untrusted ports are connected to subscribers. The Switch discards DHCP packets from untrusted ports in the following situations:

- The packet is a DHCP server packet (for example, OFFER, ACK, or NACK).
- The rate at which DHCP packets arrive is too high.

57.7.1.2 DHCP Snooping Database

The Switch stores the binding table in volatile memory. If the Switch restarts, it loads static bindings from permanent memory but loses the dynamic bindings, in which case the devices in the network have to send DHCP requests again. As a result, it is recommended you configure the DHCP snooping database.

The DHCP snooping database maintains the dynamic bindings for DHCP snooping and ARP inspection in a file on an external TFTP server. If you set up the DHCP snooping database, the Switch can reload the dynamic bindings from the DHCP snooping database after the Switch restarts.

You can configure the name and location of the file on the external TFTP server. The file has the following format:

Figure 241 DHCP Snooping Database File Format

```
<initial-checksum>
TYPE DHCP-SNOOPING
VERSION 1
BEGIN
<binding-1> <checksum-1>
<binding-2> <checksum-1-2>
...
...
<binding-n> <checksum-1-2-...-n>
END
```

The <initial-checksum> helps distinguish between the bindings in the latest update and the bindings from previous updates. Each binding consists of 72 bytes, a space, and another checksum that is used to validate the binding when it is read. If the calculated checksum is not equal to the checksum in the file, that binding and all others after it are ignored.

57.7.1.3 DHCP Relay Option 82 Information

The Switch can add information to DHCP requests that it does not discard. This provides the DHCP server more information about the source of the requests. The Switch can add the following information:

- Slot ID (1 byte), port ID (1 byte), and source VLAN ID (2 bytes)
- System name (up to 32 bytes)

This information is stored in an Agent Information field in the option 82 field of the DHCP headers of client DHCP request frames.

When the DHCP server responds, the Switch removes the information in the Agent Information field before forwarding the response to the original source.

You can configure this setting for each source VLAN. This setting is independent of the DHCP relay settings.

57.7.1.4 Configuring DHCP Snooping

Follow these steps to configure DHCP snooping on the Switch.

- 1 Enable DHCP snooping on the Switch.
- 2 Enable DHCP snooping on each VLAN, and configure DHCP relay option 82.

- 3** Configure trusted and untrusted ports, and specify the maximum number of DHCP packets that each port can receive per second.
- 4** Configure static bindings.

CHAPTER 58

Port Security

58.1 Port Security Overview

This chapter shows you how to set up port security.

58.2 About Port Security

Port security allows only packets with dynamically learned MAC addresses and/or configured static MAC addresses to pass through a port on the Switch. The Switch can learn up to 32K 8k MAC addresses in total with no limit on individual ports other than the sum cannot exceed 32K 8k.

For maximum port security, enable this feature, disable MAC address learning and configure static MAC addresses for a port. It is not recommended you disable port security together with MAC address learning as this will result in many broadcasts. By default, MAC address learning is still enabled even though the port security is not activated.

58.3 Port Security Setup

Click **SECURITY > Port Security** in the navigation panel to display the screen as shown.

Figure 242 SECURITY > Port Security

Port Security

MAC Freeze

Port List **MAC Freeze**

Port Security

Active ON

Port	Active	Address Learning	Limited Number of Learned MAC Address
*	<input type="checkbox"/>	<input type="checkbox"/>	<input type="text"/>
1	<input type="checkbox"/>	<input checked="" type="checkbox"/>	0 <input type="text"/>
2	<input type="checkbox"/>	<input checked="" type="checkbox"/>	0 <input type="text"/>
3	<input type="checkbox"/>	<input checked="" type="checkbox"/>	0 <input type="text"/>
4	<input type="checkbox"/>	<input checked="" type="checkbox"/>	0 <input type="text"/>
5	<input type="checkbox"/>	<input checked="" type="checkbox"/>	0 <input type="text"/>
6	<input type="checkbox"/>	<input checked="" type="checkbox"/>	0 <input type="text"/>
7	<input type="checkbox"/>	<input checked="" type="checkbox"/>	0 <input type="text"/>
8	<input type="checkbox"/>	<input checked="" type="checkbox"/>	0 <input type="text"/>

Apply **Cancel**

The following table describes the labels in this screen.

Table 180 SECURITY > Port Security

LABEL	DESCRIPTION
MAC Freeze	
Port List	Enter the number of the ports (separated by a comma) on which you want to enable port security and disable MAC address learning. After you click MAC Freeze , all previously learned MAC addresses on the specified ports will become static MAC addresses and display in the SWITCHING > Static MAC Forwarding screen.
MAC Freeze	Click MAC Freeze to have the Switch automatically select the Active checkboxes and clear the Address Learning checkboxes only for the ports specified in the Port List .
Port Security	
Active	Enable the switch button to enable port security on the Switch.
Port	This field displays the port number.
*	Settings in this row apply to all ports. Use this row only if you want to make some of the settings the same for all ports. Use this row first to set the common settings and then make adjustments on a port-by-port basis. Note: Changes in this row are copied to all the ports as soon as you make them.

Table 180 SECURITY > Port Security (continued)

LABEL	DESCRIPTION
Active	<p>Select this checkbox to enable the port security feature on this port. The Switch forwards packets whose MAC addresses is in the MAC address table on this port. Packets with no matching MAC addresses are dropped.</p> <p>Clear this checkbox to disable the port security feature. The Switch forwards all packets on this port.</p>
Address Learning	MAC address learning reduces outgoing broadcast traffic. For MAC address learning to occur on a port, the port itself must be active with address learning enabled.
Limited Number of Learned MAC Address	Use this field to limit the number of (dynamic) MAC addresses that may be learned on a port. For example, if you set this field to "5" on port 2, then only the devices with these five learned MAC addresses may access port 2 at any one time. A sixth device must wait until one of the five learned MAC addresses ages out. MAC address aging out time can be set in the SYSTEM > Switch Setup screen. The valid range is from "0" to "32K". "0" means this feature is disabled.
Apply	Click Apply to save your changes to the Switch's run-time memory. The Switch loses these changes if it is turned off or loses power, so use the Save link on the top navigation panel to save your changes to the non-volatile memory when you are done configuring.
Cancel	Click Cancel to begin configuring this screen afresh.

CHAPTER 59

MAINTENANCE

59.1 Overview

This chapter explains how to configure the screens that let you maintain the firmware and configuration files.

59.1.1 What You Can Do

- Use the **Certificates** screen ([Section 59.2 on page 338](#)) to see the **Certificates** screen and import the Switch's CA-signed certificates.
- Use the **Cluster Management** screens ([Section 59.5 on page 343](#)) to manage the switches within a cluster and view cluster status.
- Use the **Restore Configuration** screen ([Section 59.8 on page 348](#)) to upload a stored device configuration file.
- Use the **Backup Configuration** screen ([Section 59.9 on page 348](#)) to save your configurations for later use.
- Use the **Erase Running-Configuration** screen ([Section 59.10 on page 349](#)) to reset the configuration to the Zyxel default configuration settings.
- Use the **Save Configuration** screen ([Section 59.11 on page 350](#)) to save the current configuration settings to a specific configuration file on the Switch.
- Use the **Configure Clone** screen ([Section 59.12 on page 350](#)) to copy the basic and advanced settings from a source port to a destination port or ports.
- Use the **Diagnostic** screen ([Section 59.13 on page 352](#)) to ping IP addresses, run a traceroute, perform port tests or show the Switch's location between devices.
- Use the **Firmware Upgrade** screen ([Section 59.14 on page 355](#)) to upload the latest firmware.
- Use the **Reboot System** screen ([Section 59.15 on page 356](#)) to restart the Switch without physically turning the power off and load a specific configuration file.
- Use the **SSH Authorized Keys** screen ([Section 59.16 on page 357](#)) to authenticate secure SSH connections between a client computer and the Switch (also called the server) without needing a password to connect to the Switch.
- Use the **Tech-Support** screen ([Section 59.17 on page 364](#)) to create reports for customer support if there are problems with the Switch.

59.2 Certificates

The Switch can use HTTPS certificates that are verified by a third party to create secure HTTPS connections between your computer and the Switch. This way, you may securely access the Switch using the Web Configurator. See [Section 54.6.2 on page 311](#) for more information about HTTPS.

Certificates are based on public-private key pairs. A certificate contains the certificate owner's identity and public key. Certificates provide a way to exchange public keys for use in authentication.

Click **MAINTENANCE > Certificates** to open the following screen. Use this screen to import the Switch's CA-signed certificates.

Figure 243 MAINTENANCE > Certificates

Certificates

Certificates

Please specify the location of the HTTPS certificate file to be imported. The certificate file must be the Binary PKCS#12 format.

File Path No file chosen

Password

<input type="checkbox"/>	Service	Subject	Issuer	Valid From	Valid To
<input type="checkbox"/>	HTTPS	/CN=X33800 bc99119bb8c3	Mar 27 00:00:43 2081 GMT		

The following table describes the labels in this screen.

Table 181 MAINTENANCE > Certificates

LABEL	DESCRIPTION
File Path	Click Choose File or Browse to find the certificate file you want to upload.
Password	Enter the certificate file's password that was created when the PKCS #12 file was exported. The password consists of up to 32 printable ASCII characters except [?], [], ['], ["] or [,].
Import	Click this button to save the certificate that you have enrolled from a certification authority from your computer to the Switch.
Service	This field displays the service type that this certificate is for.
Subject	This field displays identifying information about the certificate's owner, such as CN (Common Name), OU (Organizational Unit or department), O (Organization or company) and C (Country). It is recommended that each certificate have unique subject information.
Issuer	This field displays identifying information about the certificate's issuing certification authority, such as a common name, organizational unit or department, organization or company and country.
Valid From	This field displays the date that the certificate becomes applicable.
Valid To	This field displays the date that the certificate expires.
	Select an entry's checkbox to select a specific entry.
Delete	Click this button to delete the certificate (or certification request). You cannot delete a certificate that one or more features is configured to use.

59.2.1 Install Certificates

After buying the certificates from a trusted third-party Certificate Authorities (CA), (for example, DigiCert), install the certificates. See [Importing a Certificate](#) for more information.

59.2.2 HTTPS Certificates

Use this screen to view the HTTPS certificate details. Click a hyperlink in the **Service** column in the **MAINTENANCE > Certificates** screen to open the following screen.

Figure 244 MAINTENANCE > Certificates > HTTPS

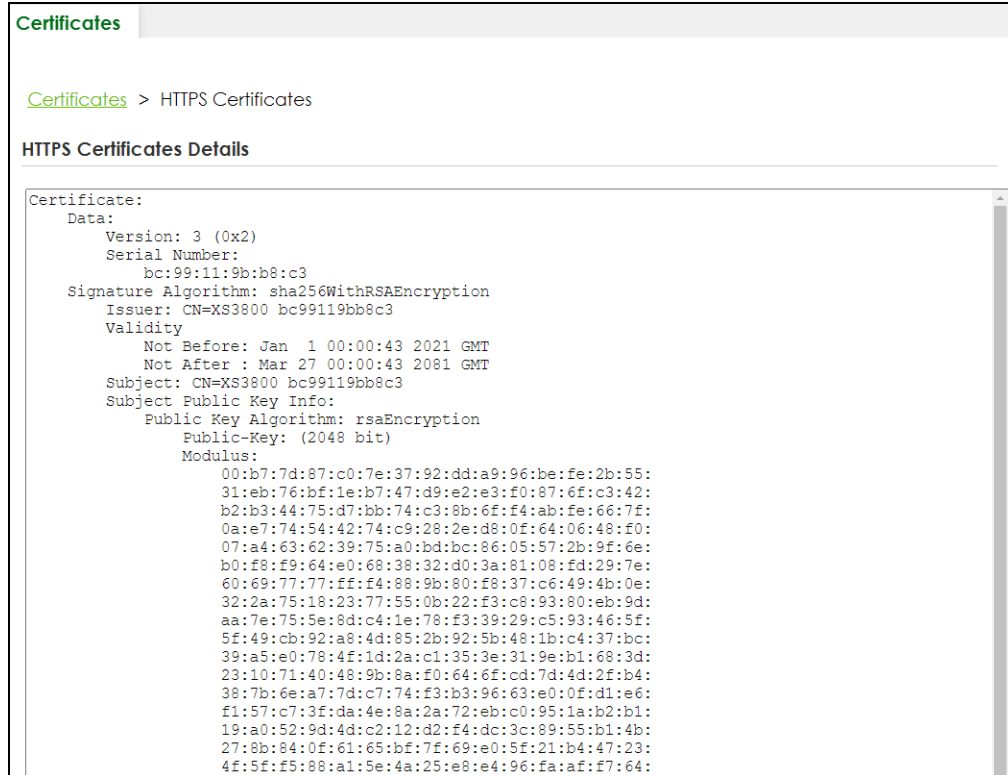

59.3 Technical Reference

This section provides technical background information on the topics discussed in this chapter.

59.3.1 FTP Command Line

This section shows some examples of uploading to or downloading files from the Switch using FTP commands. First, understand the filename conventions.

59.3.2 Filename Conventions

The configuration file (also known as the romfile or ROM) contains the Zyxel factory default configuration settings in the screens such as password, Switch setup, IP Setup, and so on. Once you have customized the Switch's settings, they can be saved back to your computer under a filename of your choosing.

ZyNOS (Zyxel Network Operating System sometimes referred to as the "ras" file) is the system firmware

and has a "bin" filename extension.

Table 182 Filename Conventions

FILE TYPE	INTERNAL NAME	EXTERNAL NAME	DESCRIPTION
Configuration File	config1 config2	*.cfg	This is the configuration filename on the Switch. Uploading the config file replaces the specified configuration file system, including your Switch configurations, system-related data (including the default password), the error log and the trace log.
Firmware	ras	*.bin	This is the generic name for the ZyNOS firmware on the Switch.

59.3.2.1 Example FTP Commands

```
ftp> put firmware.bin ras-0
```

This is a sample FTP session showing the transfer of the computer file "firmware.bin" to the Switch's **Firmware 1**.

```
ftp> get config1 config1.cfg
```

This is a sample FTP session saving the Switch's configuration file 1 (**Config1**) to a file called "config1.cfg" on your computer.

If your (T)FTP client does not allow you to have a destination filename different than the source, you will need to rename them as the Switch only recognizes "config" and "ras". Be sure you keep unaltered copies of both files for later use.

Be sure to upload the correct model firmware as uploading the wrong model firmware may damage your device.

59.3.3 FTP Command Line Procedure

- 1 Launch the FTP client on your computer.
- 2 Enter `open`, followed by a space and the IP address of your Switch.
- 3 Press [ENTER] when prompted for a user name.
- 4 Enter your password as requested (the default is "1234").
- 5 Enter `bin` to set transfer mode to binary.
- 6 Use `put` to transfer files from the computer to the Switch, for example, `put firmware.bin ras` transfers the firmware on your computer (firmware.bin) to the Switch and renames it to "ras". Similarly, `put config.cfg config1` transfers the configuration file on your computer (config.cfg) to the Switch and renames it to "config1". Likewise `get config1 config.cfg` transfers the configuration file on the Switch to your computer and renames it to "config.cfg". See [Table 182 on page 341](#) for more information on filename conventions.
- 7 Enter `quit` to exit the ftp prompt.

59.3.4 GUI-based FTP Clients

The following table describes some of the commands that you may see in GUI-based FTP clients.

Table 183 General Commands for GUI-based FTP Clients

COMMAND	DESCRIPTION
Host Address	Enter the address of the host server.
Login Type	Anonymous. This is when a user I.D. and password is automatically supplied to the server for anonymous access. Anonymous logins will work only if your ISP or service administrator has enabled this option. Normal. The server requires a unique User ID and Password to login.
Transfer Type	Transfer files in either single-byte printable characters (plain text format) or in binary mode. Configuration and firmware files should be transferred in binary mode.
Initial Remote Directory	Specify the default remote directory (path).
Initial Local Directory	Specify the default local directory (path).

59.3.5 FTP Restrictions

FTP will not work when:

- FTP service is disabled in the **SECURITY > Access Control > Service Access Control** screen.
- The IP addresses in the **SECURITY > Access Control > Remote Management** screen does not match the client IP address. If it does not match, the Switch will disconnect the FTP session immediately.

59.4 Cluster Management Overview

Cluster Management allows you to manage switches through one Switch, called the cluster manager. The switches must be directly connected and be in the same VLAN group so as to be able to communicate with one another.

Table 184 Zyxel Clustering Management Specifications

Maximum number of cluster members	24
Cluster Member Models	Must be compatible with Zyxel cluster management implementation.
Cluster Manager	The Switch through which you manage the cluster member switches.
Cluster Members	The switches being managed by the cluster manager Switch.

In the following example, switch **A** in the basement is the cluster manager and the other switches on the upper floors of the building are cluster members.

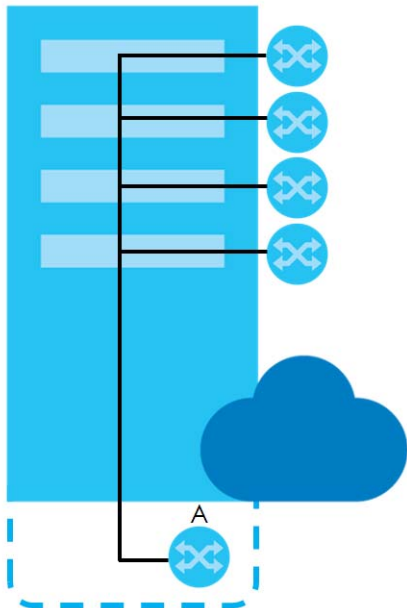
Figure 245 Clustering Application Example

59.4.1 What You Can Do

- Use the **Cluster Management Status** screen ([Section 59.5 on page 343](#)) to view the role of the Switch within the cluster and to access a cluster member Switch's Web Configurator.
- Use the **Cluster Management Setup** screen ([Section 59.6 on page 344](#)) to configure clustering management.

59.5 Cluster Management Status

Use this screen to view the role of the Switch within the cluster and to access a cluster member Switch's Web Configurator.

Click **MAINTENANCE > Cluster Management** in the navigation panel to display the following screen.

Note: A cluster can only have one manager.

Figure 246 MAINTENANCE > Cluster Management > Cluster Management Status

Cluster Management Status		Cluster Management Setup		
Status	Manager			
Manager	bc:99:bc:99:bc:99			
The Number Of Member = 1				
Index	MAC Address	Name	Model	Status
1	bc:cf:bc:cf:bc:cf	XS3800	XS3800	On-Line

The following table describes the labels in this screen.

Table 185 MAINTENANCE > Cluster Management > Cluster Management Status

LABEL	DESCRIPTION
Status	This field displays the role of this Switch within the cluster. Manager Member (you see this if you access this screen in the cluster member Switch directly and not through the cluster manager) None (neither a manager nor a member of a cluster)
Manager	This field displays the cluster manager Switch's hardware MAC address.
The Number Of Member	This field displays the number of switches that make up this cluster. The following fields describe the cluster member switches.
Index	You can manage cluster member switches through the cluster manager Switch. Each number in the Index column is a hyperlink leading to the cluster member Switch's Web Configurator.
MAC Address	This is the cluster member Switch's hardware MAC address.
Name	This is the cluster member Switch's System Name .
Model	This field displays the model name.
Status	This field displays: Online (the cluster member Switch is accessible) Error (for example the cluster member Switch password was changed or the Switch was set as the manager and so left the member list, and so on) Offline (the Switch is disconnected – Offline shows approximately 1.5 minutes after the link between cluster member and manager goes down)

59.6 Clustering Management Setup

Use this screen to configure clustering management. Click **MAINTENANCE > Cluster Management > Cluster Management Setup** to display the next screen.

Figure 247 MAINTENANCE > Cluster Management > Cluster Management Setup

Cluster Management Status | Cluster Management Setup

Clustering Manager

Active ON

Name

VID

Clustering Candidate

<input type="checkbox"/>	Index	MAC Address	Name	Model
<input type="checkbox"/>				

The following table describes the labels in this screen.

Table 186 MAINTENANCE > Cluster Management > Cluster Management Setup

LABEL	DESCRIPTION
Clustering Manager	The following fields relate to configuring the cluster manager.
Active	Enable the switch button to have this Switch become the cluster manager switch. A cluster can only have one manager. Other (directly connected) switches that are set to be cluster managers will not be visible in the Clustering Candidates list. If a Switch that was previously a cluster member is later set to become a cluster manager, then its Status is displayed as Error in the Cluster Management Status screen and a warning icon (▲) appears in the member summary list below.
Name	Type a name to identify the Clustering Manager . You may use up to 32 printable ASCII characters except [?], [], ['], ["] or [.]. (spaces are allowed).
VID	This is the VLAN ID and is only applicable if the Switch is set to 802.1Q VLAN. All switches must be directly connected and in the same VLAN group to belong to the same cluster. Switches that are not in the same VLAN group are not visible in the Clustering Candidates list. This field is ignored if the Clustering Manager is using Port-based VLAN.
Apply	Click Apply to save your changes to the Switch's run-time memory. The Switch loses these changes if it is turned off or loses power, so use the Save link on the top navigation panel to save your changes to the non-volatile memory when you are done configuring.
Cancel	Click Cancel to begin configuring this screen afresh.
Clustering Candidate	The next summary table shows the information for the clustering members configured.
Add/Edit	Click this button to create or configure a clustering candidate.
Delete	Click this button to remove the clustering candidate.
	Select an entry's checkbox to select a specific entry. Otherwise, select the checkbox in the table heading row to select all entries.
Index	This is the index number of a cluster member switch.
MAC Address	This is the cluster member switch's hardware MAC address.
Name	This is the cluster member switch's System Name .
Model	This is the cluster member switch's model name.

Click the **Add/Edit** button to open the **Add/Edit** screen. Use this screen to configure a clustering candidate for the Switch.

Figure 248 MAINTENANCE > Cluster Management > Cluster Management Setup > Add/Edit

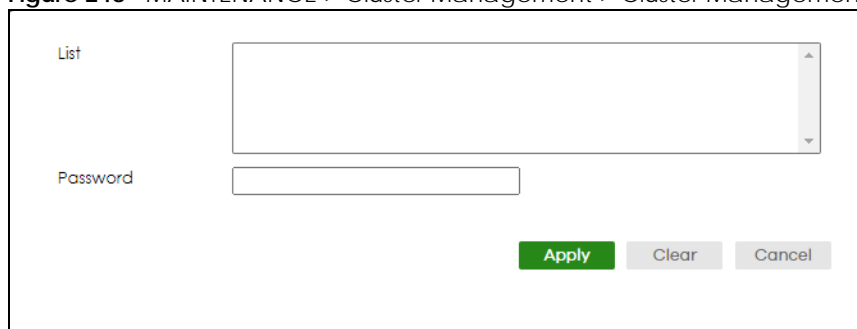

The screenshot shows a web interface for configuring a clustering candidate. It features a 'List' label next to a large, empty scrollable text area. Below this is a 'Password' label next to a smaller, empty text input field. At the bottom right of the form, there are three buttons: a green 'Apply' button, a grey 'Clear' button, and a grey 'Cancel' button.

The following table describes the labels in this screen.

Table 187 MAINTENANCE > Cluster Management > Cluster Management Setup > Add/Edit

LABEL	DESCRIPTION
List	A list of suitable candidates found by auto-discovery is shown here. The switches must be directly connected. Directly connected switches that are set to be cluster managers will not be visible in the Clustering Candidate list. Switches that are not in the same management VLAN group will not be visible in the Clustering Candidate list.
Password	<p>Each cluster member's password is its Web Configurator password. Select a member in the Clustering Candidate list and then enter its Web Configurator password. If that switch administrator changes the Web Configurator password afterwards, then it cannot be managed from the Cluster Manager. Its Status is displayed as Error in the Cluster Management Status screen.</p> <p>If multiple devices have the same password then hold [SHIFT] and click those switches to select them. Then enter their common Web Configurator password.</p> <p>You can enter up to 32 printable ASCII characters except [?], [], ['], ["] or [.].</p>
Apply	Click Apply to save your changes to the Switch's run-time memory. The Switch loses these changes if it is turned off or loses power, so use the Save link on the top navigation panel to save your changes to the non-volatile memory when you are done configuring.
Clear	Click Clear to reset the fields to the factory defaults.
Cancel	Click Cancel to begin configuring this screen afresh.

59.7 Technical Reference

This section provides technical background information on the topics discussed in this chapter.

59.7.1 Cluster Member Switch Management

Go to the **MAINTENANCE > Clustering Management > Clustering Management Status** screen of the cluster manager switch and then select an **Index** hyperlink from the list of members to go to that cluster member switch's Web Configurator home page. This cluster member Web Configurator home page and the home page that you would see if you accessed it directly are different.

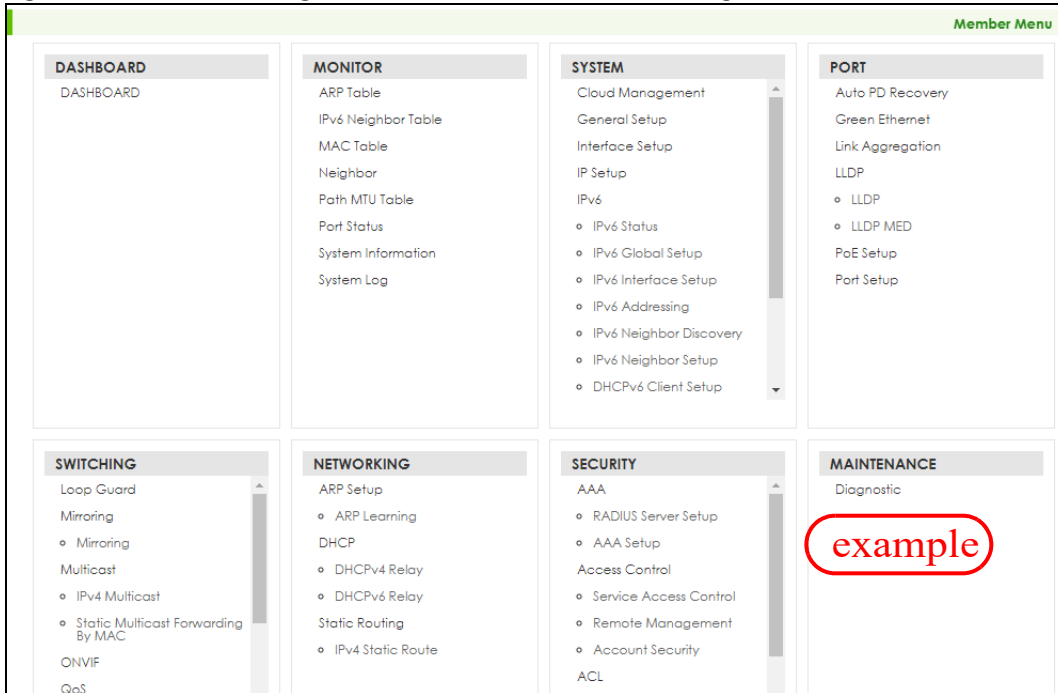
Figure 249 Cluster Management: Cluster Member Web Configurator Screen

59.7.1.1 Uploading Firmware to a Cluster Member Switch

You can use FTP to upload firmware to a cluster member switch through the cluster manager switch as shown in the following example.

Figure 250 Example: Uploading Firmware to a Cluster Member Switch

```
C:\>ftp 192.168.1.1
Connected to 192.168.1.1.
220 Switch FTP version 1.0 ready at Thu Jan  1 00:58:46 1970
User (192.168.0.1:(none)): admin
331 Enter PASS command
Password:
230 Logged in
ftp> ls
200 Port command okay
150 Opening data connection for LIST
--w--w--w-  1 owner   group           3042210 Jul  01 12:00 ras
-rw-rw-rw-  1 owner   group           393216  Jul  01 12:00 config
--w--w--w-  1 owner   group              0 Jul  01 12:00 fw-00-a0-c5-01-23-46
-rw-rw-rw-  1 owner   group              0 Jul  01 12:00 config-00-a0-c5-01-23-46
226 File sent OK
ftp: 297 bytes received in 0.00Seconds 297000.00Kbytes/sec.
ftp> bin
200 Type I OK
ftp> put 470ACAQ0.bin fw-00-a0-c5-01-23-46
200 Port command okay
150 Opening data connection for STOR fw-00-a0-c5-01-23-46
226 File received OK
ftp: 262144 bytes sent in 0.63Seconds 415.44Kbytes/sec.
ftp>
```

The following table explains some of the FTP parameters.

Table 188 FTP Upload to Cluster Member Example

FTP PARAMETER	DESCRIPTION
User	Enter "admin".
Password	The Web Configurator password default is 1234.
ls	Enter this command to list the name of cluster member switch's firmware and configuration file.
470ACAQ0.bin	This is the name of the firmware file you want to upload to the cluster member switch.
fw-00-a0-c5-01-23-46	This is the cluster member switch's firmware name as seen in the cluster manager switch.
config-00-a0-c5-01-23-46	This is the cluster member switch's configuration file name as seen in the cluster manager switch.

59.8 Restore Configuration

Use this screen to restore a previously saved configuration file (See [Section 59.9 on page 348](#) for more information on how to back up a configuration file) from your computer to the Switch.

Click **MAINTENANCE > Configuration > Restore Configuration** to access this screen.

Figure 251 MAINTENANCE > Configuration > Restore Configuration



- 1 Click **Choose File** or **Browse** to locate the configuration file you wish to restore.
- 2 After you have specified the file, click **Restore**.

The Switch will run on the restored configuration after the restore process.

Figure 252 Configuration Restoring

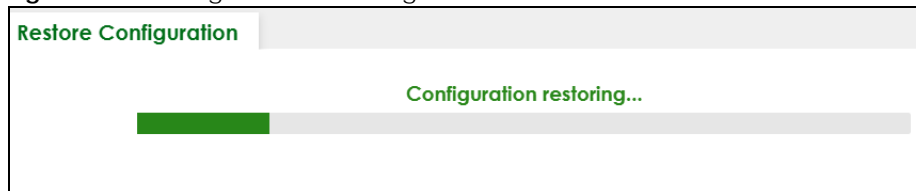

59.9 Backup Configuration

Backing up your Switch configurations allows you to create various "snap shots" of your device from which you may restore at a later date. Use this screen to back up your current Switch configuration to a computer.

To access this screen, click **MAINTENANCE > Configuration > Backup Configuration** in the navigation panel.

Figure 253 MAINTENANCE > Configuration > Backup Configuration

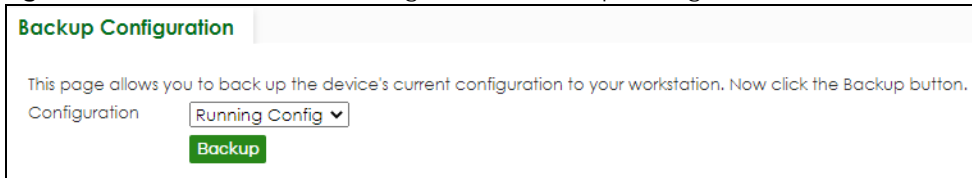

Follow the steps below to back up the current Switch configuration to your computer in this screen.

- 1 Select which Switch configuration file you want to download to your computer.
- 2 Click **Backup**.
- 3 If the current configuration file is open and/or downloaded to your computer automatically, you can click **File > Save As** on your computer to save the file to a specific place.

If a dialog box pops up asking whether you want to open or save the file, click **Save** or **Save File** to download it to the default downloads folder on your computer. If a **Save As** screen displays after you click **Save** or **Save File**, choose a location to save the file on your computer from the **Save in** drop-down list box and type a descriptive name for it in the **File name** list box. Click **Save** to save the configuration file to your computer.

59.10 Erase Running-Configuration

Follow the steps below to reset the Switch back to the Zyxel default configuration settings.

To access this screen, click **MAINTENANCE > Configuration > Erase Running Configuration** in the navigation panel.

- 1 In the **Erase Running Configuration** screen, click the **Erase** button to clear all Switch configuration information you configured and return to the Zyxel default configuration settings.

Figure 254 MAINTENANCE > Configuration > Erase Running Configuration



- 2 Click **YES** to remove the running configuration on the Switch.
- 3 In the Web Configurator, click the **Save** button in the top of the screen to make the changes take effect. If you want to access the Switch Web Configurator again, you may need to change the IP address of your computer to be in the same subnet as that of the default Switch IP address (192.168.1.1 or DHCP-assigned IP).

59.11 Save Configuration

To access this screen, click **MAINTENANCE** > **Configuration** > **Save Configuration** in the navigation panel.

Click **Config 1** to save the current configuration settings permanently to **Configuration 1** on the Switch. These configurations are set up according to your network environment.

Click **Config 2** to save the current configuration settings permanently to **Configuration 2** on the Switch. These configurations are set up according to your network environment.

Click **Custom Default** to save the current configuration settings permanently to a customized default file on the Switch. If configuration changes cause the Switch to behave abnormally, click **Custom Default** (in the **MAINTENANCE** > **Reboot System** screen) to have the Switch automatically reboot and restore the saved **Custom Default** configuration file.

Note: **Custom Default** is only available in Standalone mode.

Figure 255 MAINTENANCE > Configuration > Save Configuration (Standalone Mode)

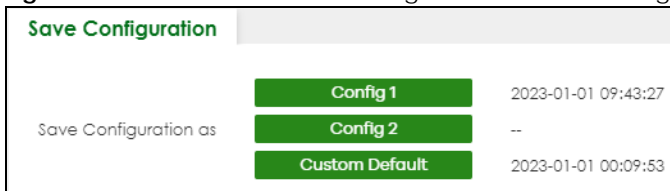
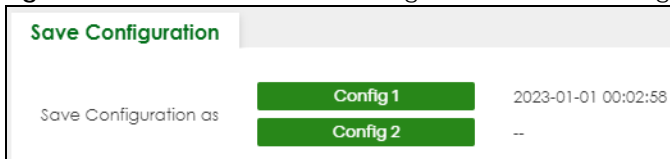

Figure 256 MAINTENANCE > Configuration > Save Configuration (Cloud Mode)



Note: If a customized default file was not saved, clicking **Custom Default** in the **MAINTENANCE** > **Reboot System** screen loads the factory default configuration on the Switch.

Alternatively, click **Save** on the top right in any screen to save the configuration changes to the current configuration.

Note: Clicking the **Apply** button after making configuration does NOT save the changes permanently. All unsaved changes are erased after you reboot the Switch.

59.12 Configure Clone

Cloning allows you to copy the basic and advanced settings from a source port to a destination port or ports. Click **MAINTENANCE** > **Configuration** > **Configure Clone** to open the following screen.

Figure 257 MAINTENANCE > Configuration > Configure Clone

The following table describes the labels in this screen.

Table 189 MAINTENANCE > Configuration > Configure Clone

LABEL	DESCRIPTION
Configure Clone	
Source/ Destination	Enter the source port under the Source label. This port's attributes are copied.
Port	Enter the destination port or ports under the Destination label. These are the ports which are going to have the same attributes as the source port. You can enter individual ports separated by a comma or a range of ports by using a dash. Example: 2, 4, 6 indicates that ports 2, 4 and 6 are the destination ports. 2-6 indicates that ports 2 through 6 are the destination ports.
Port Features	
	Select a feature's checkbox to select a specific feature. Otherwise, select the checkbox in the table heading row to select all features for a category.
SYSTEM	Select the system feature (you configured in the SYSTEM menus) to be copied to the destination ports. Otherwise, select the SYSTEM checkbox in the table heading row to select all features for a category.
PORT	Select which port features (you configured in the PORT menus) should be copied to the destination ports. Otherwise, select the PORT checkbox in the table heading row to select all features for a category.

Table 189 MAINTENANCE > Configuration > Configure Clone (continued)

LABEL	DESCRIPTION
SWITCHING	Select which switching features (you configured in the SWITCHING menus) should be copied to the destination ports. Otherwise, select the SWITCHING checkbox in the table heading row to select all features for a category.
NETWORKING	Select the networking feature (you configured in the NETWORKING menus) to be copied to the destination ports. Otherwise, select the NETWORKING checkbox in the table heading row to select all features for a category.
SECURITY	Select which security features (you configured in the SECURITY menus) should be copied to the destination ports. Otherwise, select the SECURITY checkbox in the table heading row to select all features for a category.
Apply	Click Apply to save your changes to the Switch's run-time memory. The Switch loses these changes if it is turned off or loses power, so use the Save link on the top navigation panel to save your changes to the non-volatile memory when you are done configuring.
Cancel	Click Cancel to begin configuring this screen afresh.

59.13 Diagnostic

Click **MAINTENANCE > Diagnostic** in the navigation panel to open this screen. Use this screen to ping IP addresses, run a traceroute, perform port tests or show the Switch's location between devices.

Figure 258 MAINTENANCE > Diagnostic

Diagnostic

Port	Channel	Pair status	Cable length (m)	Distance to fault (m)
2	pairA	Ok	71.00	N/A
	pairB	Ok	71.00	N/A
	pairC	Ok	71.00	N/A
	pairD	Ok	71.00	N/A

Ping Test

IPv4 -

IPv6 -

IP Address/Host Name

Count

Ping

Trace Route Test

IPv4 -

IPv6 -

IP Address/Host Name

TTL

Wait Time Seconds

Queries

Trace Route

Ethernet Port Test

Port

Port Test

Cable Diagnostics ⓘ

Port

Diagnose

Locator LED

Minutes

Blink Stop

The following table describes the labels in this screen.

Table 190 MAINTENANCE > Diagnostic

LABEL	DESCRIPTION
Ping Test	
IPv4	Select this option if you want to ping an IPv4 address. Otherwise, select - to send ping requests to all VLANs on the Switch.
IPv6	Select this option if you want to ping an IPv6 address. You can also select vlan and specify the ID number of the VLAN to which the Switch is to send ping requests. Otherwise, select - to send ping requests to all VLANs on the Switch.
IP Address/Host Name	Type the IP address or host name of a device that you want to ping in order to test a connection. Click Ping to have the Switch ping the IP address.
Count	Enter the number of ICMP Echo Request (ping) messages the Switch continuously sends.
Trace Route Test	
IPv4	Select this option if you want to trace the route packets taken to a device with an IPv4 address. Otherwise, select - to trace the path on any VLAN. Note: The device to which you want to run a traceroute must belong to the VLAN you specify here.

Table 190 MAINTENANCE > Diagnostic (continued)

LABEL	DESCRIPTION
IPv6	Select this option if you want to trace the route packets taken to a device with an IPv6 address.
IP Address/Host Name	Enter the IP address or host name of a device to which you want to perform a traceroute. Click Trace Route to have the Switch perform the traceroute function. This determines the path a packet takes to the specified device.
TTL	Enter the Time To Live (TTL) value for the ICMP Echo Request packets. This is to set the maximum number of the hops (routers) a packet can travel through. Each router along the path will decrement the TTL value by one and forward the packets. When the TTL value becomes zero and the destination is not found, the router drops the packets and informs the sender.
Wait Time	Specify how many seconds the Switch waits for a response to a probe before running another traceroute.
Queries	Specify how many times the Switch performs the traceroute function.
Ethernet Port Test	
Port	Enter a port number and click Port Test to perform an internal loopback test.
Port	This is the number of the physical Ethernet port on the Switch.
Cable Diagnostics	
Port	Enter a port number and click Diagnose to perform a physical wire-pair test of the Ethernet connections on the specified ports. The following fields display when you diagnose a port. Note: This feature is limited to within 100 meters only.
Port	This is the number of the physical Ethernet port on the Switch.
Channel	An Ethernet cable usually has four pairs of wires. A 10BASE-T or 100BASE-TX port only use and test two pairs, while a 1000BASE-T port requires all four pairs. This displays the descriptive name of the wire-pair in the cable.
Pair status	Ok: The physical connection between the wire-pair is okay. Open: There is no physical connection (an open circuit detected) between the wire-pair. Short: There is an short circuit detected between the wire-pair. Unknown: The Switch failed to run cable diagnostics on the cable connected this port. Unsupported: The port is a fiber port or it is not active.
Cable length	This displays the total length of the Ethernet cable that is connected to the port when the Pair status is Ok and the Switch chipset supports this feature. This shows N/A if the Pair status is Open or Short . Check the Distance to fault . This shows Unsupported if the Switch chipset does not support to show the cable length.
Distance to fault	This displays the distance between the port and the location where the cable is open or shorted. This shows N/A if the Pair status is Ok . This shows Unsupported if the Switch chipset does not support to show the distance.
Locator LED	Enter a time interval (in minutes) and click Blink to show the actual location of the Switch between several devices in a rack. The default time interval is 30 minutes. Click Stop to have the Switch terminate the blinking locator LED.

59.14 Firmware Upgrade

You can upgrade the Switch's firmware through Web Configurator or NCC.

Firmware Upgrade Through NCC

In cloud management mode, NCC will first check if the firmware on the Switch needs to be upgraded. If it does, the Switch will upgrade the firmware immediately. If the firmware does not need to be upgraded, but there is newer firmware available for the Switch, then it will be upgraded according to the firmware upgrade schedule for the Switch on the NCC.

On the NCC web portal, go to **Site-wide > Configure > Firmware management** to schedule the firmware upgrade time.

Note: While the Switch is rebooting, do NOT turn off the power.

Firmware Upgrade Through the Web Configurator

Use the following screen to upgrade your Switch to the latest firmware. The Switch supports dual firmware images, **Firmware 1** and **Firmware 2**. Use this screen to specify which image is updated when firmware is uploaded using the Web Configurator and to specify which image is loaded when the Switch starts up.

Note: Make sure you have downloaded (and unzipped) the correct model firmware and version to your computer before uploading to the device.

Click **MAINTENANCE > Firmware Upgrade** to view the screen as shown next.

Figure 259 MAINTENANCE > Firmware Upgrade

Firmware Upgrade

Firmware Upgrade

Name	Version	
GS1350-26HP	Running	V4.90(ABPL.0)b3 10/30/2023
	Firmware 1	V4.90(ABPL.0)b2 09/27/2023
	Firmware 2	V4.90(ABPL.0)b3 10/30/2023

Boot Image

Current Boot Image: Firmware 2
 Config Boot Image: Firmware

To upgrade the switch firmware, browse the location of the binary (.BIN) file and click Upgrade button.

Firmware:
 File Path: No file chosen

The top of the screen shows which firmware version is currently **Running** on the Switch. Click **Choose File** or **Browse** to locate the firmware file you wish to upload to the Switch in the **File Path** field. Click **Upgrade** to load the new firmware. The Switch does not apply the uploaded firmware immediately. Firmware upgrades are only applied after you reboot the Switch using the uploaded firmware.

Click the **Config Boot Image** drop-down list box to select the boot image (**Firmware1** or **Firmware2**) you want the Switch to use when rebooting, click **Apply**. Restart the Switch (manually or using the **MAINTENANCE > Reboot System** screen) to apply the firmware image you selected.

After the process is complete, see the **DASHBOARD** screen to verify your current firmware version number.

Table 191 MAINTENANCE > Firmware Upgrade

LABEL	DESCRIPTION
Name	This is the name of the Switch that you are configuring.
Version	The Switch has 2 firmware sets, Firmware 1 and Firmware 2 , residing in flash. <ul style="list-style-type: none"> • Running shows the version number (and model code) and MM/DD/YYYY creation date of the firmware currently in use on the Switch (Firmware 1 or Firmware 2). The firmware information is also displayed at System Information in Basic Setting. • Firmware 1 shows its version number (and model code) and MM/DD/YYYY creation date. • Firmware 2 shows its version number (and model code) and MM/DD/YYYY creation date.
Boot Image	
Current Boot Image	This displays which firmware is currently in use on the Switch (Firmware 1 or Firmware 2).
Config Boot Image	Select which firmware (Firmware 1 or Firmware 2) should load, click Apply and reboot the Switch to see changes, you will also see changes in the Current Boot Image field above as well.
Apply	Click Apply to save your changes to the Switch's run-time memory. The Switch loses these changes if it is turned off or loses power, so use the Save link on the top navigation panel to save your changes to the non-volatile memory when you are done configuring.
Cancel	Click Cancel to begin configuring this screen afresh.
Firmware	Choose to upload the new firmware to (Firmware) 1 or (Firmware) 2 .
File Path	Click Choose File or Browse to locate the firmware file you wish to upload to the Switch.
Upgrade	Click Upgrade to load the new firmware. Firmwares are only applied after a reboot. To reboot, go to MAINTENANCE > Reboot System and click Config 1 , Config 2 or Factory Default (Config 1 , Config 2 , Factory Default , and Custom Default are the configuration files you want the Switch to use when it restarts).

59.15 Reboot System

Reboot System allows you to restart the Switch without physically turning the power off. It also allows you to load configuration one (**Config 1**), configuration two (**Config 2**), a **Custom Default** or the **Factory Default** configuration when you reboot. Follow the steps below to reboot the Switch.

Note: **Custom Default** is only available in Standalone mode.

Click **MAINTENANCE > Reboot System** to view the screen as shown next.

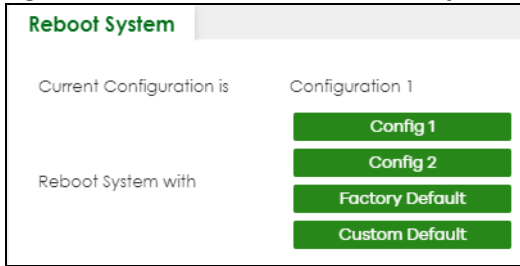
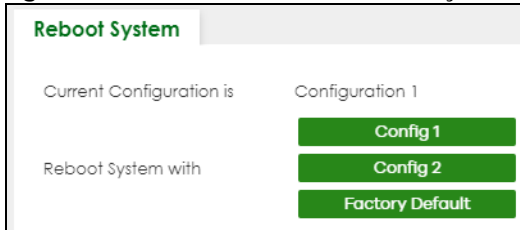
Figure 260 MAINTENANCE > Reboot System (Standalone Mode)**Figure 261** MAINTENANCE > Reboot System (Cloud Mode)

- 1 Click the **Config 1**, **Config 2**, **Factory Default**, or **Custom Default** button to reboot and load that configuration file. The confirmation screen displays.

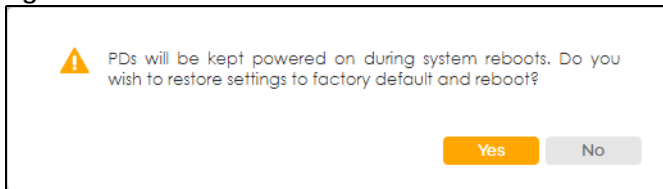
Figure 262 Reboot Confirmation

- 2 Click **YES** and then wait for the Switch to restart. This takes up to 2 minutes.

Click **Config 1** and follow steps 1 to 2 to reboot and load configuration one on the Switch.

Click **Config 2** and follow steps 1 to 2 to reboot and load configuration two on the Switch.

Click **Factory Default** and follow steps 1 to 2 to reboot and load Zyxel factory default configuration settings on the Switch.

Click **Custom Default** and follow steps 1 to 2 to reboot and load a customized default file on the Switch. This will save the custom default configuration settings to both **Configuration 1** and **Configuration 2**.

Note: If a customized default file was not saved, clicking **Custom Default** loads the factory default configuration on the Switch.

59.16 SSH Authorized Keys

The Switch can use SSH-authorized keys to authenticate secure SSH connections between a client computer and the Switch (also called the server) without needing a password to connect to the Switch. You can use a third-party utility to generate a private and public key for SSH, for example:

- In Windows, use the PuTTY terminal emulator

- In Linux Ubuntu, use the “ssh-keygen” command.

The Switch and the client computer should have a unique set of private and public keys for encryption/decryption. See [Section 54.6.1 on page 310](#) for more information about SSH.

Click **MAINTENANCE > SSH Authorized Keys** to open the following screen. Use this screen to import the client computer’s public key into the Switch.

Figure 263 MAINTENANCE > SSH Authorized Keys

The following table describes the labels in this screen.

Table 192 MAINTENANCE > SSH Authorized Keys

LABEL	DESCRIPTION
File Path	Click Choose File or Browse to find the authorized key file you want to upload.
Import	Click this button to save the authorized key file you want to import from your computer to the Switch.
	Select an entry’s checkbox to select a specific key.
User	This field displays the user name of the authorized key file (up to 32 characters).
Hostname	This field displays the hostname of the authorized key file (up to 32 characters only).
Content	This field displays the actual encryption key’s text string (up to 64 characters).
Delete	After selecting an entry’s checkbox, click this button to delete the authorized key file.

59.16.1 Generate the SSH Authorized Keys

You must install an SSH client program on a client computer (Windows or Linux operating system) to connect to the Switch over SSH.

Example – Generate the SSH Authorized Keys on Windows

PuTTY is a free and open-source terminal emulator. It supports the SSH network protocol. To generate the SSH-authorized keys in PuTTY, the following are the steps at the time of writing:

- 1 Run PuTTYgen.

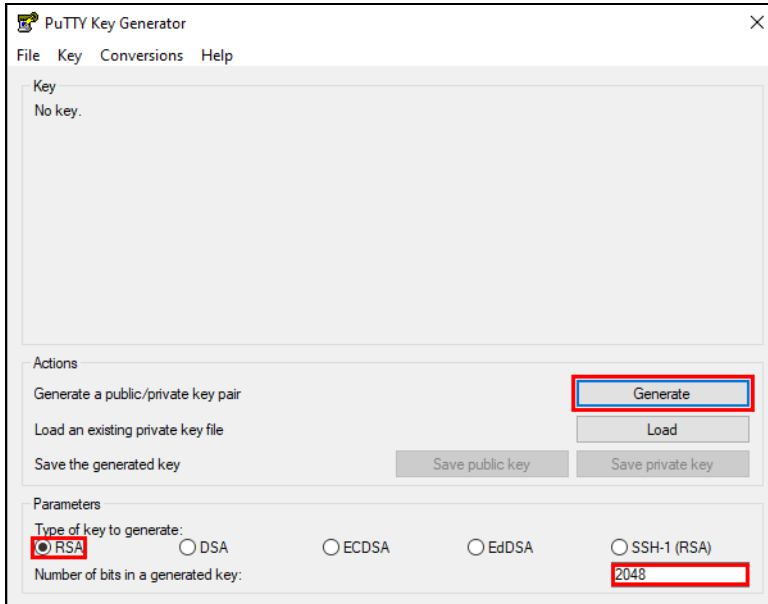

- 2 Select **RSA** in the **Type of key to generate**. RSA (Rivest-Shamir-Adleman) is an asymmetric encryption scheme that generates its keys by multiplying two pseudo-random prime numbers. Enter **2048** in the **Number of bits in a generated key**. SSH keys with encryption lower than 2048 are considered insecure. Then click **Generate**.
- 3 Move the mouse back and forth over the blank area to complete the key generation.

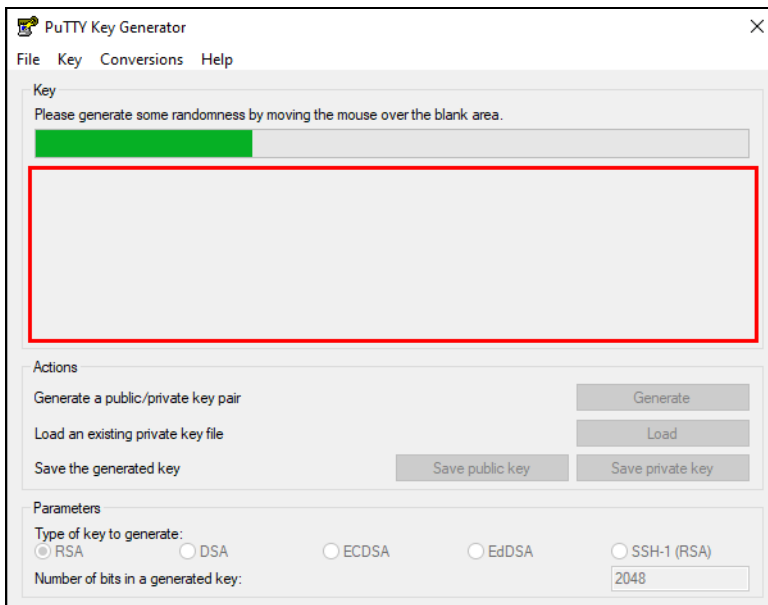

- 4 (Optional) The **Key passphrase** and **Confirm passphrase** fields allow you to set a passphrase for your key. Use the passphrase to encrypt the key on your computer. When set, you need to enter the passphrase to use the key. See step 5 on [Run PuTTY for SSH Connections on Windows](#) for more information.

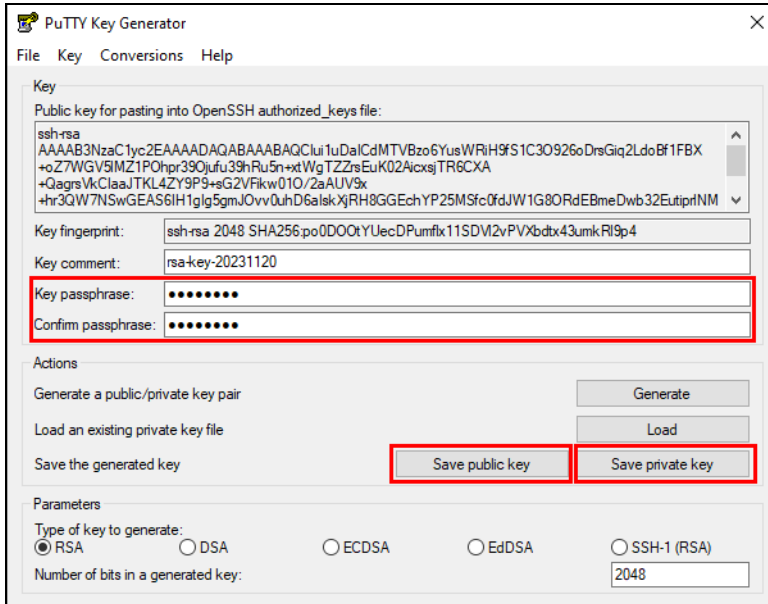

- 5 Click **Save public key** and **Save private key** to save the generated keys in your computer.
- 6 Copy the text on the generated public key into a text editor app like Notepad.

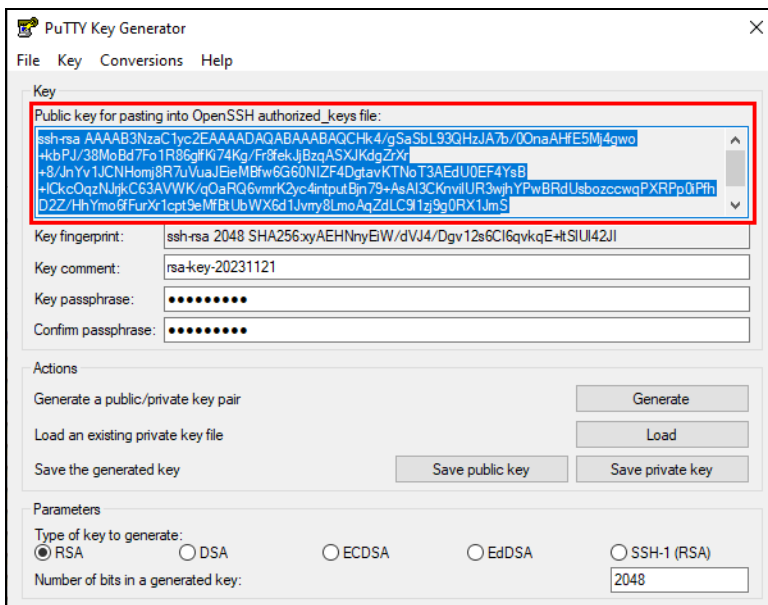

- 7 At the end of the text string, enter "**@(Hostname)**". This will appear in the **Hostname** field in the **MAINTENANCE > SSH Authorized Keys** screen. Press **Enter** to add a line break, then save the text file. Import the text file into the Switch using the **SSH Authorized Keys** screen.

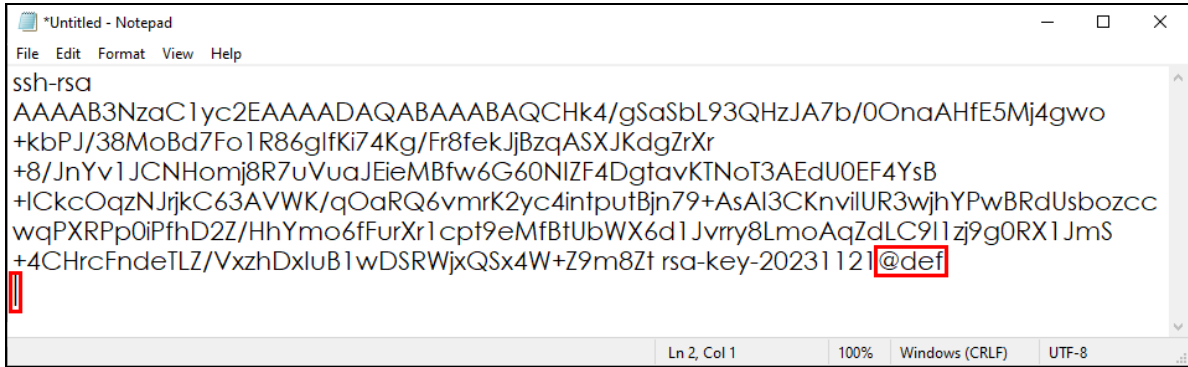

```

*Untitled - Notepad
File Edit Format View Help
SSH-RSA
AAAAB3NzaC1yc2EAAAADAQABAAQChk4/gSaSbL93QHzJA7b/0OnaAHfE5Mj4gwo
+kbPJ/38MoBd7Fo1R86glfKi74Kg/Fr8fekJjBzqASXJKdgZrXr
+8/JnYv1JCNHomj8R7uVuaJEieMBfw6G60NIZF4DgtavKTNoT3AEdu0EF4YsB
+HCkcOqzNjrkC63AVWK/qOaRQ6vmrK2yc4intputBjn79+AsAI3CKnvilUR3wjhYPwBRdUsbozcc
wqPXRpp0IPfhD2Z/HhYmo6fFurXr1cpt9eMfBUbWX6d1Jvry8LmoAqZdLC911zj9g0RX1JmS
+4CHrcFndeTLZ/VxzhDxluB1wDSRWjxQSx4W+Z9m8Zt rsa-key-20231121@def
Ln 2, Col 1 100% Windows (CRLF) UTF-8

```

Note: The Switch only supports one SSH-authorized key at a time. Only one client computer can authenticate without entering a password using an SSH connection.

Run PuTTY for SSH Connections on Windows

To use PuTTY to connect to the Switch through SSH, the following are the steps at the time of writing:

- 1 Run PuTTY. In the **Session** screen, enter the IP address of the Switch and “22” for the **Port**. Select **SSH** for the **Connection type**.

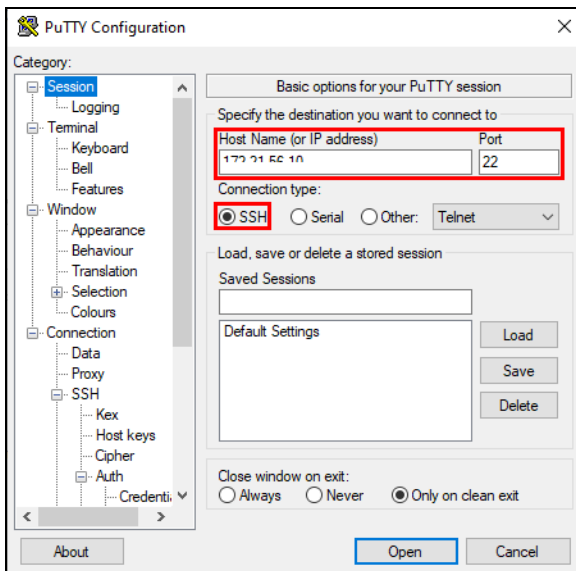

- 2 In the **Data** screen, enter **admin** for **Auto-login username**. The Switch only supports the **admin** login for the SSH-authorized key.

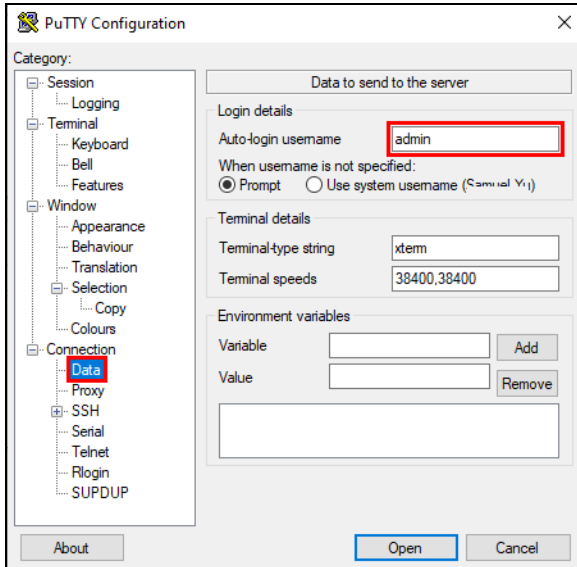

- 3 In the **Credentials** screen, click **Browse** to locate the generated private key.

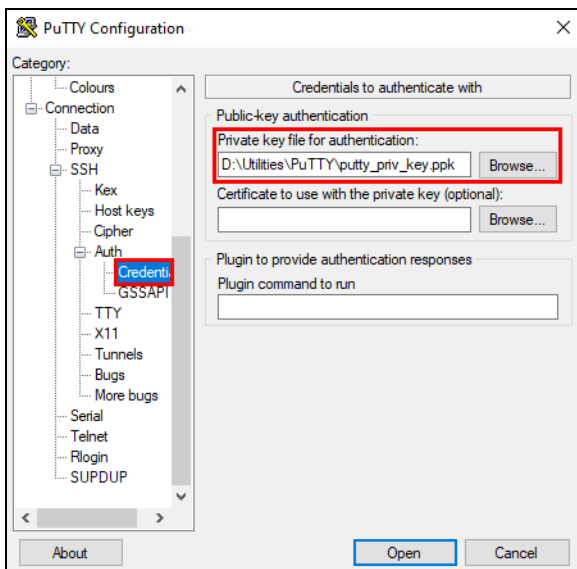

- 4 In the **Session** screen, you can save the PuTTY configuration by entering a name (for example, "Sample") in the **Saved Sessions**, then click **Save**. Click **Open** to start the SSH connection.

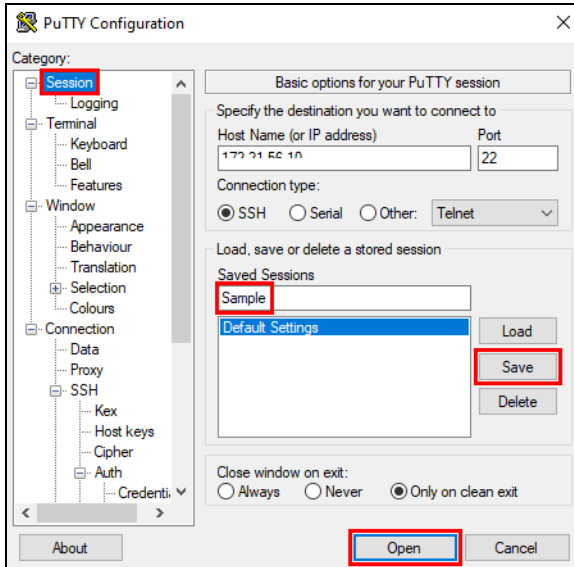

- 5 Enter the **Passphrase for key** if you configured the **Key passphrase** in step 4 of using the PuTTY Key Generator.

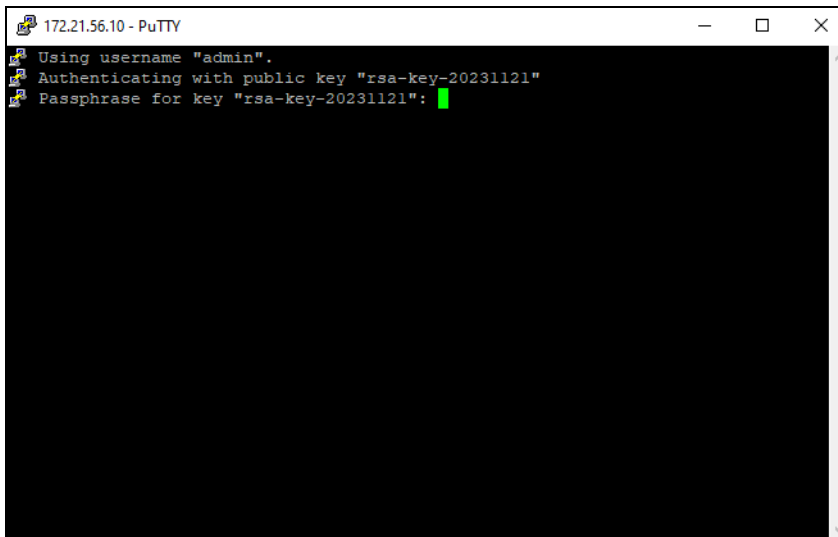

You have now logged in to the Switch.

```

172.21.56.10 - PuTTY
Using username "admin".
Authenticating with public key "rsa-key-20231121"
Passphrase for key "rsa-key-20231121":
Copyright (c) 2023 Zyxel and/or its affiliates. All Rights Reserved.
Last successful login time: 02:04:47 (UTC+07:00) 2023-11-21
GS1350#

```

Example – Generate the SSH Authorized Keys on Linux

To generate the SSH-authorized keys in Ubuntu, enter the following commands at the time of writing:

```

UserA@UbuntuClient:~$ ssh-keygen -t rsa -b 2048
.....(enter..)
UserA@UbuntuClient:~$ ls -all .ssh/
.....
-rw-----  1 UserA UserA  1831 Mar 25  09:46 id_rsa
-rw-r--r--  1 UserA UserA   408 Mar 25  09:46 id_rsa.pub
.....

```

"id_rsa" is the private key and "id_rsa.pub" is the public key generated in Ubuntu.

59.17 Tech-Support

The Tech-Support feature is a log enhancement tool that logs useful information such as CPU utilization history, memory and Mbuf (Memory Buffer) log and crash reports for issue analysis by customer support should you have difficulty with your Switch. The Tech Support menu eases your effort in obtaining reports and it is also available in CLI command by entering the "Show tech-support" command.

Click **MAINTENANCE > Tech-Support** to see the following screen.

Figure 264 MAINTENANCE > Tech-Support

Tech-Support

CPU Threshold % Keep Seconds

Mbuf Threshold %

[Apply](#) [Cancel](#)

All [Download](#)

Crash [Download](#)

CPU [Download](#)

Memory [Download](#)

Mbuf [Download](#)

ROM [Download](#)

You may need WordPad or similar software to see the log report correctly. The table below describes the fields in the above screen.

Table 193 MAINTENANCE > Tech-Support

LABEL	DESCRIPTION
CPU	Type a number ranging from 50 to 100 in the CPU threshold box, and type another number ranging from 5 to 60 in the seconds box then click Apply . For example, 80 for CPU threshold and 5 for seconds means a log will be created when CPU utilization reaches over 80% and lasts for 5 seconds. The log report holds 7 days of CPU log data and is stored in volatile memory (RAM). The data is lost if the Switch is turned off or in event of power outage. After 7 days, the logs wrap around and new ones and replace the earliest ones. The higher the CPU threshold number, the fewer logs will be created, and the less data technical support will have to analyze and vice versa.
Mbuf	Type a number ranging from 50 to 100 in the Mbuf (Memory Buffer) threshold box. The Mbuf log report is stored in flash (permanent) memory. For example, Mbuf 50 means a log will be created when the Mbuf utilization is over 50%. The higher the Mbuf threshold number, the fewer logs will be created, and the less data technical support will have to analyze and vice versa.
Apply	Click Apply to save your changes to the Switch's run-time memory. The Switch loses these changes if it is turned off or loses power, so use the Save link on the top navigation panel to save your changes to the non-volatile memory when you are done configuring.
Cancel	Click Cancel to begin configuring this screen afresh.
All	Click Download to see all the log report and system status. This log report is stored in flash memory. If the All log report is too large, you can download the log reports separately below.
Crash	Click Download to see the crash log report. The log will include information of the last crash and is stored in flash memory.
CPU	Click Download to see the CPU history log report. The 7-days log is stored in RAM and you will need to save it, otherwise it will be lost when the Switch is shutdown or during power outage.
Memory	Click Download to see the memory section log report. This log report is stored in flash memory.

Table 193 MAINTENANCE > Tech-Support (continued)

LABEL	DESCRIPTION
Mbuf	Click Download to see the Mbuf (Memory Buffer) log report. This log report is stored in flash memory.
ROM	Click Download to see the Read Only Memory (ROM) log report. This report is stored in flash memory.

59.17.1 Tech-Support Download

When you click **Download** to save your current Switch configuration to a computer, the following screen appears. When the log report has downloaded successfully, click **Back** to return to the previous screen.

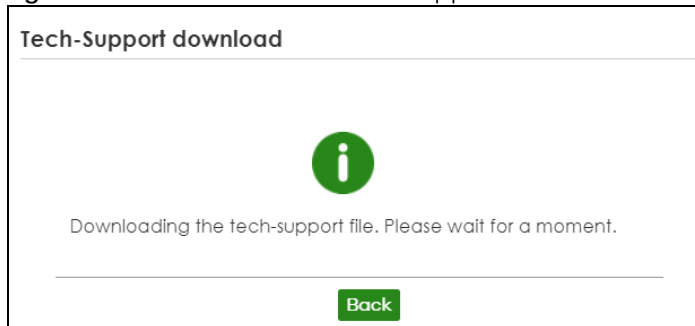
Figure 265 MAINTENANCE > Tech-Support: Download

CHAPTER 60

Surveillance Mode

60.1 Overview

Aside from the Web Configurator in Standard mode that has a complete set of configuration for network installation, you can switch to Surveillance mode.

Surveillance mode is a set of menus specifically designed for users who are mostly using the Switch for configuring and managing PoE devices like IP cameras.

Use a browser that supports HTML5, such as Microsoft Edge, Mozilla Firefox, or Google Chrome. The recommended screen resolution is 1366 by 768 pixels.

The following sections introduce the configuration and functions of the Web Configurator in Surveillance mode.

Click **Surveillance** at the top left of the Web Configurator to switch between the Web Configurator's **Standard** or **Surveillance** mode.

Figure 266 Web Configurator - Surveillance Mode (Standalone Mode)



Figure 267 Web Configurator - Surveillance Mode (Cloud Mode)

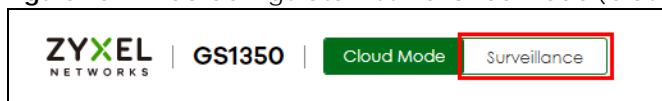

This section describes the screens for System Status and Neighbor Details.

60.1.1 What You Can Do

- Use the **Summary** screen ([Section 60.2 on page 367](#)) to see the Switch's general device information, system status, and IP addresses. You can also display other status screens for more information.
- Use the **Neighbor Detail** screen ([Section 60.3 on page 369](#)) to view and manage Switch's neighbor devices.

60.2 Summary

The **Summary** screen displays when you log into the Switch or click **Summary** at the top left corner of the Web Configurator. The **Summary** screen displays general device information, system status, connected ports, and used power for PoE devices.

Figure 268 Summary

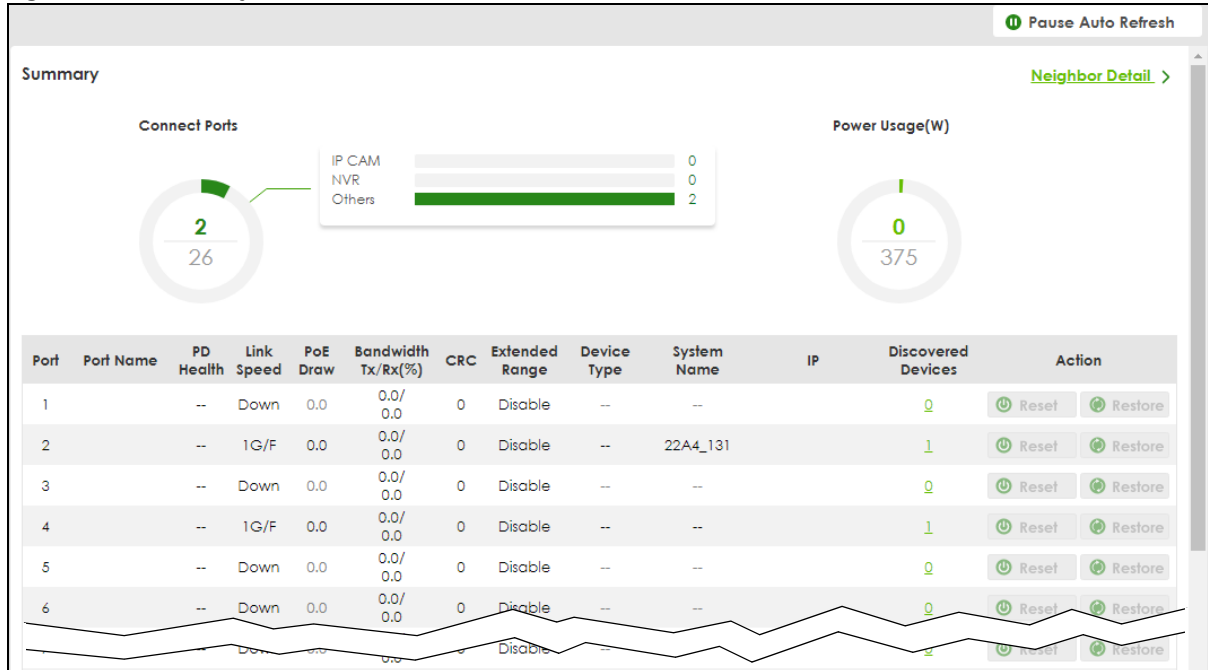

The following table describes the labels in this screen.

Table 194 Summary

LABEL	DESCRIPTION
Pause/Resume Auto Refresh	Enter the number of seconds when the Summary screen details will be updated. Click the Pause or Play icon to stop or resume the screen update.
Connect Ports	This chart displays the number of ports with connection (IP CAM + NVR + Others) over the total number of ports on this Switch.
Power Usage(W)	This chart displays the used PoE Watts over the total number of Watts provided on this Switch.
Port	This field displays the port of this Switch.
Port Name	This field displays the port description of this Switch.
PD Health	<p>This field displays the status of auto PD recovery on this port.</p> <ul style="list-style-type: none"> Red: The Switch failed to get information from the PD connected to the port using LLDP, or the connected PD did not respond to the Switch's ping requests. Yellow: The Switch is restarting the connected PD by turning the power off and turning it on again. Green: The Switch successfully discovered the connected PD using LLDP or ping. --: Auto PD Recovery is not enabled on the Switch and the port, or the Switch does not supply power to the connected PD. <p>Note: The status will NOT be updated instantaneously after enabling or disabling the Active switch in the Port > Auto PD Recovery screen. It will wait until the configured Resume Polling Interval (sec) has lapsed.</p>
Link Speed	This shows the speed (either 10M for 10 Mbps, 100M for 100 Mbps, or 1G for 1 Gbps) and the duplex (F for full duplex or H for half). This field displays Down if the port is not connected to any device.
PoE Draw	This shows the consumption that the neighboring device connected to this port draws from the Switch. This allows you to plan and use within the power budget of the Switch.
Bandwidth Tx/Rx (%)	This field displays the percentage of bandwidth usage on this port as a percentage of the Link Speed .
CRC	This field displays the number of packets received with CRC (Cyclic Redundant Check) errors.

Table 194 Summary (continued)

LABEL	DESCRIPTION
Extended Range	This field shows whether PoE range is extended up to 250 meters for the port on this Switch.
Device Type	This field displays the model name of this Switch.
System Name	This field displays the name used to identify the Switch on any network.
IP	This field displays the Switch's current IPv4 address.
Discovered Devices	This field displays the Neighbor Detail of the discovered device by clicking the link.
Action	<p>Click the Reset button to restart the neighbor device. A warning message "Are you sure you want to reboot the powered device?" appears prompting you to confirm the action. After confirming the action a count down button (from 5 to 0) starts.</p> <p>Click the Restore button to reset the neighbor device to its factory default settings. A warning message "Are you sure you want to reset the AP to factory default?" appears prompting you to confirm the action.</p>

60.3 Neighbor Detail Screen

The **Neighbor Detail** screen allows you to view and manage the Switch's neighboring devices more conveniently. It uses Layer Link Discovery Protocol (LLDP) to discover all neighbor devices connected to the Switch including non-Zyxel devices. You can perform tasks on the neighboring devices like login, reboot (turn the power off and then back on again), and reset to factory default settings in the **Neighbor Detail** screen.

This screen shows the neighboring device first recognized on an Ethernet port of the Switch. Device information is displayed in gray when the neighboring device is offline.

Up to 10 neighboring device records per Ethernet port can be retained in this screen even when the devices are offline. When the maximum number of neighboring device records per Ethernet port is reached, new device records automatically overwrite existing offline device records, starting with the oldest existing offline device record first.

Click **Summary > Neighbor Detail** to see the following screen.

Figure 269 Summary > Neighbor Detail

Neighbor Detail [Summary](#)

Search Ports...

Port 1

Port Name:	PD Health: --	Link Speed: Down	PoE Draw: 0.0
Bandwidth Tx/Rx(%): 0.0/ 0.0	CRC: 0	Extend Range: Disable	PD Failed Count: 0

Port 2

Port Name:	PD Health: --	Link Speed: 1G/F	PoE Draw: 0.0
Bandwidth Tx/Rx(%): 0.0/ 0.0	CRC: 0	Extend Range: Disable	PD Failed Count: 0

Remote

System Name: 22A4_131	Port: 11	Model: XGS3700-48HP	IP: 0.0.0.0
Location: HQ2_R202	Desc.:	Firmware: V4.30(AAGF.2)_20230214 02/14/2023	MAC: E4-18-6B-F8-20-EB
		3	Device Type: --

Port 3

Port Name:	PD Health: --	Link Speed: Down	PoE Draw: 0.0
Bandwidth Tx/Rx(%): 0.0/ 0.0	CRC: 0	Extend Range: Disable	PD Failed Count: 0

Port 4

Port Name:	PD Health: --	Link Speed: 1G/F	PoE Draw: 0.0
Bandwidth Tx/Rx(%): 0.0/ 0.0	CRC: 0	Extend Range: Disable	PD Failed Count: 0

Remote

System Name:	Port:	Model:	IP:
--------------	-------	--------	-----

The following table describes the fields in this screen.

Table 195 Summary > Neighbor Detail

LABEL	DESCRIPTION
Search Ports...	Enter the port number and click the magnify icon to view and manage the neighboring device connected to the port.
Flush All	Click the Flush All button to remove information about neighbors learned on all the ports of the Switch.
Port	This shows the port of the Switch, on which the neighboring device is discovered.
Flush	Click the Flush button to remove information about neighbors learned on the selected ports.
Port Name	This shows the port description of the Switch.
PD Health	<p>This shows the status of auto PD recovery on this port.</p> <ul style="list-style-type: none"> Red: The Switch failed to get information from the PD connected to the port using LLDP, or the connected PD did not respond to the Switch's ping requests. Yellow: The Switch is restarting the connected PD by turning the power off and turning it on again. Green: The Switch successfully discovered the connected PD using LLDP or ping. --: Auto PD Recovery is not enabled on the Switch and the port, or the Switch does not supply power to the connected PD. <p>Note: The status will NOT be updated instantaneously after enabling or disabling the Active switch in the Port > Auto PD Recovery screen. It will wait until the configured Resume Polling Interval (sec) has lapsed.</p>

Table 195 Summary > Neighbor Detail (continued)

LABEL	DESCRIPTION
Link Speed	This shows the speed (either 10M for 10 Mbps, 100M for 100 Mbps, or 1G for 1 Gbps) and the duplex (F for full duplex or H for half). This field displays Down if the port is not connected to any device.
PoE Draw (W)	This shows the consumption that the neighboring device connected to this port draws from the Switch. This allows you to plan and use within the power budget of the Switch.
Action	Click the Reset button to turn OFF the power of the neighbor device and turn it back ON again. Note: The Switch must support power sourcing (PSE) or the network device is a powered device (PD).
Bandwidth Tx/Rx (%)	This field displays the percentage of bandwidth usage on this port as a percentage of the Link Speed .
CRC	This shows the number of packets received with CRC (Cyclic Redundant Check) errors.
Extend Range	This shows whether PoE range is extended up to 250 meters for the port on this Switch.
PD Failed Count	Note: Make sure Auto PD Recovery is enabled on your Switch (see Section 64.2 on page 388). This shows the number of times the Switch attempts to restart the PD on the port. The PD Failed Count will reset after clicking the Flush button.
System Name	This shows the system name of the neighbor device.
Port	This shows the number of the neighbor device's port which is connected to the Switch.
Model	This shows the model name of the neighbor device. This field will show "--" for devices that do not support the ZON utility.
IP	This shows the IPv4 or IPv6 address of the neighbor device. The IPv4 or IPv6 address is a hyper link that you can click to log into and manage the neighbor device through its Web Configurator.
Action	Click the Restore button to reset the neighboring device to its factory default settings. A warning message " Are you sure you want to reset the AP to factory default? " appears prompting you to confirm the action. <ul style="list-style-type: none"> The Switch must support power sourcing (PSE) or the network device is a powered device (PD). If multiple neighbor devices use the same port, the Default button is not available. You can only reset Zyxel powered devices that support the ZON utility.
Location	This shows the geographic location of the neighbor device. This field will show "--" for devices that do not support the ZON utility.
Desc.	This shows the description of the neighbor device's port which is connected to the Switch.
Firmware	This shows the firmware version of the neighbor device. This field will show "--" for devices that do not support the ZON utility.
MAC	This shows the MAC address of the neighbor device.
Device Type	This field displays the IP-based security products, for example IP camera or NVR (network video recorder), that is connected to this Switch.

CHAPTER 61

Quick Setup

Use the **Quick Setup** screen to display the **IP Address Information** of the Switch and links to the **IP Setup**, **Auto PD Recovery**, **PoE Setup**, **Port Setup**, and **ONVIF** screens.

61.1 Quick Setup Screen

Click **QUICK SETUP** in the navigation panel to display this screen.

Figure 270 QUICK SETUP

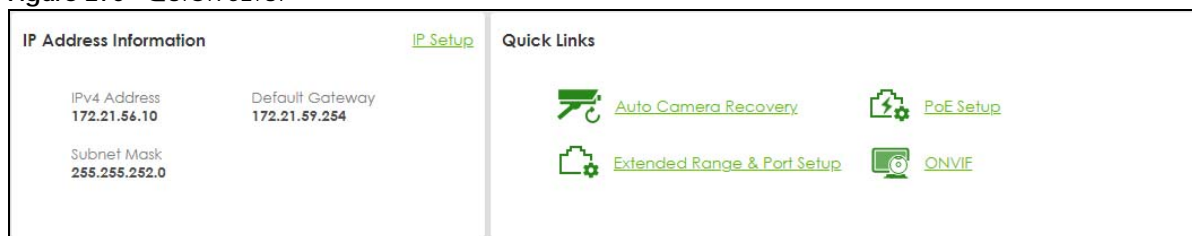

The following table describes the labels in this screen.

Table 196 QUICK SETUP

LABEL	DESCRIPTION
IP Address Information	
IPv4 Address	This displays the IP address of the Switch for it to be managed over the network.
Subnet Mask	This displays the subnet mask that specifies the network number portion of an IP address.
Default Gateway	This displays the IP address of the default outgoing gateway in dotted decimal notation.
IP Setup	This link takes you to a screen where you can configure the IP address and subnet mask (necessary for Switch management) and set up to 64 IP routing domains.
Quick Links	
Auto Camera Recovery	This link takes you to a screen where you can enable and configure Auto PD Recovery on the Switch.
PoE Setup	This link takes you to a screen where you can set priorities, PoE power-up settings and schedule so that the Switch is able to reserve and allocate power to certain PDs.
Extended Range & Port Setup	This link takes you to a screen where you can configure settings for individual Switch ports.
ONVIF	This link takes you to a screen where you can configure a specific VLAN to run ONVIF (Open Network Video Interface Forum) protocol.

CHAPTER 62

Monitor

62.1 What You Can Do

Use the **System Information** screen (Section 62.2 on page 373) to check the firmware version number and monitor the Switch temperature.

62.2 System Information

In the navigation panel, click **MONITOR > System Information** to display the screen as shown. Use this screen to view general system information. You can check the firmware version number and monitor the Switch temperature.

Figure 271 MONITOR > System Information

System Information			
System Name	GS1350		
Product Model	GS1350-26HP		
ZyNOS F/W Version	V4.90(ABPL0)b3 11/06/2023		
Ethernet Address	d8:ec:e5:cf:66:4c		
CPU Utilization Current (%)	28.29		

Memory Utilization			
Name	Total (byte)	Used (byte)	Utilization (%)
common	35381248	5137520	14

Hardware Monitor					
Temperature (C)	Status	Current	MAX	MIN	Threshold
CPU/MAC	Normal	48.0	49.0	47.0	89.0

The following table describes the labels in this screen.

Table 197 MONITOR > System Information

LABEL	DESCRIPTION
System Name	This field displays the descriptive name of the Switch for identification purposes.
Product Model	This field displays the product model of the Switch. Use this information when searching for firmware upgrade or looking for other support information in the website.
ZyNOS F/W Version	This field displays the version number of the Switch 's current firmware including the date created.

Table 197 MONITOR > System Information (continued)

LABEL	DESCRIPTION
Ethernet Address	This field refers to the Ethernet MAC (Media Access Control) address of the Switch.
CPU Utilization Current (%)	CPU utilization quantifies how busy the system is. Current (%) displays the current percentage of CPU utilization.
Memory Utilization	Memory utilization shows how much DRAM memory is available and in use. It also displays the current percentage of memory utilization.
Name	This field displays the name of memory pool.
Total (byte)	This field displays the total number of bytes in this memory pool.
Used (byte)	This field displays the number of bytes being used in this memory pool.
Utilization (%)	This field displays the percentage (%) of memory being used in this memory pool.
Hardware Monitor	
Temperature Unit	The Switch has temperature sensors that are capable of detecting and reporting if the temperature rises above the threshold. You may choose the temperature unit (Centigrade or Fahrenheit) in this field.
Temperature (C)	CPU/MAC refers to the location of the temperature sensor on the Switch printed circuit board.
Status	This field displays Normal for temperatures below the threshold and Error for those above.
Current	This shows the current temperature at this sensor.
MAX	This field displays the maximum temperature measured at this sensor.
MIN	This field displays the minimum temperature measured at this sensor.
Threshold	This field displays the upper temperature limit at this sensor.

CHAPTER 63

System

63.1 What You Can Do

- Use the **Cloud Management** screen ([Section 63.2 on page 375](#)) to turn on Nebula Control Center (NCC) discovery on the Switch.
- Use the **General Setup** screen ([Section 63.3 on page 377](#)) to configure general settings such as the system name and time.
- Use the **IP Setup** screen ([Section 63.4 on page 378](#)) to configure the default gateway device, the default domain name server and add IP domains.
- Use the **Logins** screen ([Section 63.5 on page 380](#)) to configure the user name and password, and passwords and privilege level for up to 4 users.
- Use the **SNMP** screen ([Section 63.6 on page 381](#)) to configure general SNMP settings.
- Use the **SNMP User** screen ([Section 63.7 on page 383](#)) to create SNMP users for authentication with managers using SNMP v3 and associate them to SNMP groups.
- Use the **SNMP Trap Group** screen ([Section 63.8 on page 385](#)) to specify the types of SNMP traps that should be sent to each SNMP manager.
- Use the **SNMP Trap Port** screen ([Section 63.9 on page 386](#)) to enable/disable sending SNMP traps on a port.

63.2 Cloud Management

The Switch supports NebulaFlex which can set the Switch to operate in either standalone or Nebula cloud management mode. When the Switch is in standalone mode, it can be configured and managed by the Web Configurator. When the Switch is in Nebula cloud management mode, it can be managed and provisioned by the Zyxel Nebula Control Center (NCC).

The Zyxel Nebula Control Center (NCC) is a cloud-based network management system that allows you to remotely manage and monitor Zyxel Nebula APs, Ethernet switches and security gateways.

The Switch is managed and provisioned automatically by the NCC (Nebula Control Center) when:

- The Switch is connected to the Internet.
- The **Nebula Control Center Discovery** feature is enabled.
- The Switch has been registered in the NCC.

The **Cloud Management** screen displays links to **Nebula Switch Registration** which has a QR code containing the Switch's serial number and MAC address for handy registration of the Switch at NCC.

Click **SYSTEM > Cloud Management** in the navigation panel to display this screen.

Figure 272 SYSTEM > Cloud Management

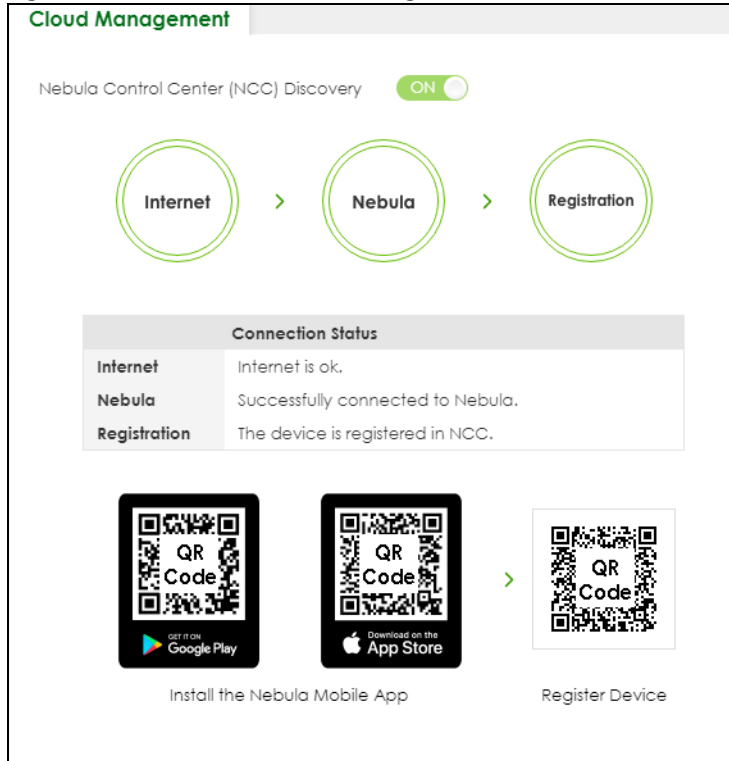

Select **ON** to turn on NCC discovery on the Switch. If the Switch has Internet access and has been registered in the NCC, it will go into cloud management mode.

In cloud management mode, then NCC will first check if the firmware on the Switch needs to be upgraded. If it does, the Switch will upgrade the firmware immediately. If the firmware does not need to be upgraded, but there is newer firmware available for the Switch, then it will be upgraded according to the firmware upgrade schedule for the Switch on the NCC. Below is the process for upgrading firmware:

- 1 Download firmware through the NCC.
- 2 Upgrade the firmware and reboot.

Note: While the Switch is rebooting, do NOT turn off the power.

Disable **ON** to turn off NCC discovery on the Switch. The Switch will NOT discover the NCC and remain in standalone mode.

This screen has a QR code containing the Switch's serial number and MAC address for handy NCC registration of the Switch using the Nebula Mobile app. First, download the app from the Google Play store for Android devices or the App Store for iOS devices and create an organization and site.

63.3 General Setup

Use this screen to configure general settings such as the system name and time. Click **SYSTEM > General Setup** in the navigation panel to display the screen as shown.

Figure 273 SYSTEM > General Setup

The following table describes the labels in this screen.

Table 198 SYSTEM > General Setup

LABEL	DESCRIPTION
System Name	Choose a descriptive name for identification purposes. This name consists of up to 64 printable characters; spaces are allowed.
Location	Enter the geographic location of your Switch. You can use up to 128 printable ASCII characters; spaces are allowed.
Contact Person's Name	Enter the name of the person in charge of this Switch. You can use up to 32 printable ASCII characters; spaces are allowed.
Use Time Server when Bootup	<p>Enter the time service protocol that your time server uses. Not all time servers support all protocols, so you may have to use trial and error to find a protocol that works. The main differences between them are the time format.</p> <p>When you select the Daytime (RFC 867) format, the Switch displays the day, month, year and time with no time zone adjustment. When you use this format it is recommended that you use a Daytime timeserver within your geographical time zone.</p> <p>Time (RFC-868) format displays a 4-byte integer giving the total number of seconds since 1970/1/1 at 0:0:0.</p> <p>NTP (RFC-1305) is similar to Time (RFC-868).</p> <p>None is the default value. Enter the time manually. Each time you turn on the Switch, the time and date will be reset to 1970-1-1 0:0:0.</p>
Time Server IP Address	Enter the IP address or domain name of your timeserver. The Switch searches for the timeserver for up to 60 seconds.

Table 198 SYSTEM > General Setup (continued)

LABEL	DESCRIPTION
Time Server Sync Interval	Enter the period in minutes between each time server synchronization. The Switch checks the time server after every synchronization interval.
Current Time	This field displays the time you open this menu (or refresh the menu).
New Time (hh:min:ss)	Enter the new time in hour, minute and second format. The new time then appears in the Current Time field after you click Apply .
Current Date	This field displays the date you open this menu.
New Date (yyyy-mm-dd)	Enter the new date in year, month and day format. The new date then appears in the Current Date field after you click Apply .
Time Zone	Select the time difference between UTC (Universal Time Coordinated, formerly known as GMT, Greenwich Mean Time) and your time zone from the drop-down list box.
Daylight Saving Time	<p>Daylight saving is a period from late spring to early fall when many countries set their clocks ahead of normal local time by one hour to give more daytime light in the evening.</p> <p>Set the switch to ON if you use Daylight Saving Time.</p>
Start Date	<p>Configure the day and time when Daylight Saving Time starts if you selected Daylight Saving Time. The time is displayed in the 24 hour format. Here are a couple of examples:</p> <p>Daylight Saving Time starts in most parts of the United States on the second Sunday of March. Each time zone in the United States starts using Daylight Saving Time at 2 A.M. local time. So in the United States you would select Second, Sunday, March and 2:00.</p> <p>Daylight Saving Time starts in the European Union on the last Sunday of March. All of the time zones in the European Union start using Daylight Saving Time at the same moment (1 A.M. GMT or UTC). So in the European Union you would select Last, Sunday, March and the last field depends on your time zone. In Germany for instance, you would select 2:00 because Germany's time zone is one hour ahead of GMT or UTC (GMT+1).</p>
End Date	<p>Configure the day and time when Daylight Saving Time ends if you selected Daylight Saving Time. The time field uses the 24 hour format. Here are a couple of examples:</p> <p>Daylight Saving Time ends in the United States on the first Sunday of November. Each time zone in the United States stops using Daylight Saving Time at 2 A.M. local time. So in the United States you would select First, Sunday, November and 2:00.</p> <p>Daylight Saving Time ends in the European Union on the last Sunday of October. All of the time zones in the European Union stop using Daylight Saving Time at the same moment (1 A.M. GMT or UTC). So in the European Union you would select Last, Sunday, October and the last field depends on your time zone. In Germany for instance, you would select 2:00 because Germany's time zone is one hour ahead of GMT or UTC (GMT+1).</p>
Apply	Click Apply to save your changes to the Switch's run-time memory. The Switch loses these changes if it is turned off or loses power, so use the Save link on the top navigation panel to save your changes to the non-volatile memory when you are done configuring.
Cancel	Click Cancel to begin configuring this screen afresh.

63.4 IP Setup

Use the **IP Setup** screen to configure the default gateway device, the default domain name server and add IP domains. See [Section 21.3 on page 129](#) for more information on IP setup.

Figure 274 SYSTEM > IP Setup

The following table describes the labels in this screen.

Table 199 SYSTEM > IP Setup

LABEL	DESCRIPTION
Domain Name Server	
Domain Name Server 1/2	Enter a domain name server IPv4 address in order to be able to use a domain name instead of an IP address.
Default Management IP Address	
Use these fields to create or edit IP routing domains on the Switch.	
DHCP Client	Select this option if you have a DHCP server that can assign the Switch an IP address, subnet mask, a default gateway IP address and a domain name server IP address automatically.
Static IP Address	Select this option if you do not have a DHCP server or if you wish to assign static IP address information to the Switch. You need to fill in the following fields when you select this option.
IP Address	Enter the IP address of your Switch in dotted decimal notation, for example, 172.21.40.x. This is the IP address of the Switch in an IP routing domain.
IP Subnet Mask	Enter the IP subnet mask of an IP routing domain in dotted decimal notation, for example, 255.255.252.0.
Default Gateway	Type the IP address of the default outgoing gateway in dotted decimal notation, for example 172.21.43.254.
VID	Enter the VLAN identification number to which an IP routing domain belongs.
Apply	Click Apply to save your changes to the Switch's run-time memory. The Switch loses these changes if it is turned off or loses power, so use the Save link on the top navigation panel to save your changes to the non-volatile memory when you are done configuring.
Cancel	Click Cancel to reset the fields to your previous configuration.
Management IP Address	
Use these fields to set the settings for the management port.	
	Select an entry's checkbox to select a specific entry. Otherwise, select the checkbox in the table heading row to select all entries.
Index	This field displays the index number of an entry.

Table 199 SYSTEM > IP Setup (continued)

LABEL	DESCRIPTION
IP Address	This field displays IP address of the Switch in the IP domain.
IP Subnet Mask	This field displays the subnet mask of the Switch in the IP domain.
VID	This field displays the VLAN identification number of the IP domain on the Switch.
Default Gateway	This field displays the IP address of the default outgoing gateway in dotted decimal notation.
Add/Edit	Click this button to create new / configure settings for the management port.
Delete	Click this button to remove the settings for the management port.

63.5 Set Up Login Accounts

Up to 5 people (one administrator and four non-administrators) may access the Switch through Web Configurator at any one time.

- An administrator is someone who can both view and configure Switch changes. The username for the Administrator is always **admin**. The default administrator password is **1234**.
- A non-administrator (username is something other than **admin**) is someone who can view and/or configure Switch settings. The configuration right varies depending on the user's privilege level.

Click **SYSTEM > Logins** to view the screen as shown.

Figure 275 SYSTEM > Logins

Logins

Administrator

User Name

Old Password

New Password

Retype to confirm

 Please record your new password whenever you change it. The system will lock you out if you have forgotten your password.

Edit Logins

Login	User Name	Password	Retype to confirm	Privilege
1	<input type="text"/>	<input type="text"/>	<input type="text"/>	<input type="text"/>
2	<input type="text"/>	<input type="text"/>	<input type="text"/>	<input type="text"/>
3	<input type="text"/>	<input type="text"/>	<input type="text"/>	<input type="text"/>
4	<input type="text"/>	<input type="text"/>	<input type="text"/>	<input type="text"/>

The following table describes the labels in this screen.

Table 200 SYSTEM > Logins

LABEL	DESCRIPTION
Administrator	
This is the default administrator account with the "admin" user name. You can change the default administrator user name.	
User Name	Change the default "admin" user name (up to 32 printable ASCII characters except [?], [], ['], ["], or [,]).
Old Password	Type the existing system password (1234 is the default password when shipped).
New Password	Enter your new system password.
Retype to confirm	Retype your new system password for confirmation.
Edit Logins	
You may configure passwords for up to four users. These users can have read-only or read/write access. You can give users higher privileges through the Web Configurator or the CLI. For more information on assigning privileges through the CLI see the Ethernet Switch CLI Reference Guide.	
Login	This field displays the index number of an entry.
User Name	Set a user name (up to 32 ASCII characters long).
Password	Enter your new system password.
Retype to confirm	Retype your new system password for confirmation.
Privilege	<p>Type the privilege level for this user. At the time of writing, users may have a privilege level of 0, 3, 13, or 14 representing different configuration rights as shown below.</p> <ul style="list-style-type: none"> • 0 – Display basic system information. • 3 – Display configuration or status. • 13 – Configure features except for login accounts, SNMP user accounts, the authentication method sequence and authorization settings, multiple logins, administrator and enable passwords, and configuration information display. • 14 – Configure login accounts, SNMP user accounts, the authentication method sequence and authorization settings, multiple logins, and administrator and enable passwords, and display configuration information. <p>Users can run command lines if the session's privilege level is greater than or equal to the command's privilege level. The session privilege initially comes from the privilege of the login account. For example, if the user has a privilege of 5, he or she can run commands that requires privilege level of 5 or less but not more.</p>
Apply	Click Apply to save your changes to the Switch's run-time memory. The Switch loses these changes if it is turned off or loses power, so use the Save link on the top navigation panel to save your changes to the non-volatile memory when you are done configuring.
Cancel	Click Cancel to begin configuring this screen afresh.

63.6 Configure SNMP

Use this screen to configure your SNMP settings. Simple Network Management Protocol (SNMP) is an application layer protocol used to manage and monitor TCP/IP-based devices. SNMP is used to exchange management information between the network management system (NMS) and a network element (NE). A manager station can manage and monitor the Switch through the network through SNMP version 1 (SNMPv1), SNMP version 2c or SNMP version 3. See [About SNMP](#) for more information.

Click **SYSTEM > SNMP** to view the screen as shown.

Figure 276 SYSTEM > SNMP

SNMP SNMP User SNMP Trap Group SNMP Trap Port

General Setting

Version: v2c
 Get Community: public
 Set Community: public
 Trap Community: public

Trap Destination

Index	Version	IP	Port	Username
1	v2c	0.0.0.0	162	
2	v2c	0.0.0.0	162	
3	v2c	0.0.0.0	162	
4	v2c	0.0.0.0	162	

Apply Cancel

The following table describes the labels in this screen.

Table 201 SYSTEM > SNMP

LABEL	DESCRIPTION
General Setting	Use this section to specify the SNMP version and community (password) values.
Version	Select the SNMP version for the Switch. The SNMP version on the Switch must match the version on the SNMP manager. Choose SNMP version 2c (v2c), SNMP version 3 (v3) or both (v3v2c). SNMP version 2c is backwards compatible with SNMP version 1.
Get Community	Enter the Get Community string, which is the password for the incoming Get- and GetNext-requests from the management station. The Get Community string is only used by SNMP managers using SNMP version 2c or lower.
Set Community	Enter the Set Community , which is the password for incoming Set- requests from the management station. The Set Community string is only used by SNMP managers using SNMP version 2c or lower.
Trap Community	Enter the Trap Community string, which is the password sent with each trap to the SNMP manager. The Trap Community string is only used by SNMP managers using SNMP version 2c or lower.
Trap Destination	Use this section to configure where to send SNMP traps from the Switch.
Index	This field displays the index number of an entry.
Version	Specify the version of the SNMP trap messages.
IP	Enter the IP addresses of up to 4 managers to send your SNMP traps to.
Port	Enter the port number upon which the manager listens for SNMP traps.
Username	Enter the username to be sent to the SNMP manager along with the SNMP v3 trap. This username must match an existing account on the Switch (configured in the SYSTEM > SNMP > SNMP User screen).

Table 201 SYSTEM > SNMP (continued)

LABEL	DESCRIPTION
Apply	Click Apply to save your changes to the Switch's run-time memory. The Switch loses these changes if it is turned off or loses power, so use the Save link on the top navigation panel to save your changes to the non-volatile memory when you are done configuring.
Cancel	Click Cancel to begin configuring this screen afresh.

63.7 Configure SNMP User

From the **SNMP** screen, click **SNMP User** to view the screen as shown. Use the **SNMP User** screen to view SNMP users for authentication with managers using SNMP v3. An SNMP user is an SNMP manager.

Figure 277 SYSTEM > SNMP > SNMP User

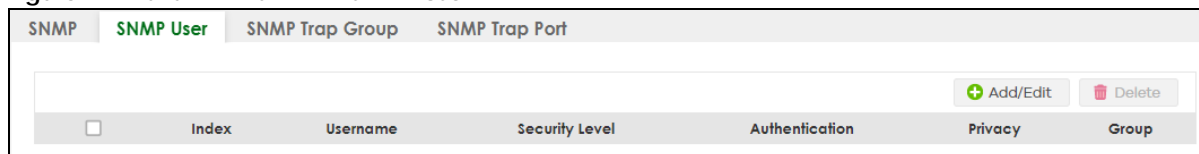

The following table describes the labels in this screen.

Table 202 SYSTEM > SNMP > SNMP User

LABEL	DESCRIPTION
	Select an entry's checkbox to select a specific entry. Otherwise, select the checkbox in the table heading row to select all entries.
Index	This is a read-only number identifying a login account on the Switch. Click on an index number to view more details and edit an existing account.
Username	This field displays the username of a login account on the Switch.
Security Level	This field displays whether you want to implement authentication and/or encryption for SNMP communication with this user.
Authentication	This field displays the authentication algorithm used for SNMP communication with this user.
Privacy	This field displays the encryption method used for SNMP communication with this user.
Group	This field displays the SNMP group to which this user belongs.
Add/Edit	Click this button to create new / configure SNMP users for authentication with managers.
Delete	Click this button to remove the selected entry from the summary table.

Click **Add** or **Edit** button to open the following screen. Use this screen to create or edit SNMP users for authentication with managers using SNMP v3 and associate them to SNMP groups.

Figure 278 SYSTEM > SNMP > SNMP User > Add or Edit User Information

The screenshot shows a web form for configuring an SNMP user. It contains the following elements:

- Username:** A text input field.
- Security Level:** A dropdown menu with 'no auth' selected.
- Authentication:** A dropdown menu with 'MD5' selected.
- Privacy:** A dropdown menu with 'DES' selected.
- Group:** A dropdown menu with 'admin' selected.
- Password:** Two text input fields for authentication and encryption passwords.
- Buttons:** 'Apply' (green), 'Clear', and 'Cancel' (grey).

The following table describes the labels in this screen.

Table 203 SYSTEM > SNMP > SNMP User > Add or Edit User Information

LABEL	DESCRIPTION
Username	Specify the username of a login account on the Switch.
Security Level	<p>Select whether you want to implement authentication and/or encryption for SNMP communication from this user. Choose:</p> <ul style="list-style-type: none"> no auth – to use the username as the password string to send to the SNMP manager. This is equivalent to the Get, Set and Trap Community in SNMP v2c. This is the lowest security level. auth – to implement an authentication algorithm for SNMP messages sent by this user. priv – to implement authentication and encryption for SNMP messages sent by this user. This is the highest security level. <p>Note: The settings on the SNMP manager must be set at the same security level or higher than the security level settings on the Switch.</p>
Authentication	Select an authentication algorithm. MD5 (Message Digest 5) and SHA (Secure Hash Algorithm) are hash algorithms used to authenticate SNMP data. SHA authentication is generally considered stronger than MD5, but is slower.
Password	Enter the password of up to 32 ASCII characters for SNMP user authentication.
Privacy	Specify the encryption method for SNMP communication from this user. You can choose one of the following:
	<ul style="list-style-type: none"> DES – Data Encryption Standard is a widely used (but breakable) method of data encryption. It applies a 56-bit key to each 64-bit block of data. AES – Advanced Encryption Standard is another method for data encryption that also uses a secret key. AES applies a 128-bit key to 128-bit blocks of data.
Password	Enter the password of up to 32 ASCII characters for encrypting SNMP packets.
Group	<p>SNMP v3 adopts the concept of View-based Access Control Model (VACM) group. SNMP managers in one group are assigned common access rights to MIBs. Specify in which SNMP group this user is.</p> <p>admin – Members of this group can perform all types of system configuration, including the management of administrator accounts.</p> <p>read-write – Members of this group have read and write rights, meaning that the user can create and edit the MIBs on the Switch, except the user account and AAA configuration.</p> <p>read-only – Members of this group have read rights only, meaning the user can collect information from the Switch.</p>
Apply	<p>Click this to create a new entry or to update an existing one.</p> <p>This saves your changes to the Switch's run-time memory. The Switch loses these changes if it is turned off or loses power, so use the Save link on the top navigation panel to save your changes to the non-volatile memory when you are done configuring.</p>

Table 203 SYSTEM > SNMP > SNMP User > Add or Edit User Information (continued)

LABEL	DESCRIPTION
Clear	Click Clear to reset the fields to the factory defaults.
Cancel	Click Cancel to reset the fields to your previous configuration.

63.8 Configure SNMP Trap Group

The Switch sends traps to an SNMP manager when an event occurs. From the **SNMP** screen, click **SNMP Trap Group** to view the screen as shown. Use the **SNMP Trap Group** screen to specify the types of SNMP traps that should be sent to each SNMP manager.

Figure 279 SYSTEM > SNMP > SNMP Trap Group

The following table describes the labels in this screen.

Table 204 SYSTEM > SNMP > SNMP Trap Group

LABEL	DESCRIPTION
Trap Destination IP	Select one of your configured trap destination IP addresses. These are the IP addresses of the SNMP managers. You must first configure a trap destination IP address in the SNMP Setting screen. Use the rest of the screen to select which traps the Switch sends to that SNMP manager.
Type	Select the categories of SNMP traps that the Switch is to send to the SNMP manager.
Options	Select the individual SNMP traps that the Switch is to send to the SNMP station. The traps are grouped by category. Selecting a category automatically selects all of the category's traps. Clear the checkboxes for individual traps that you do not want the Switch to send to the SNMP station. Clearing a category's checkbox automatically clears all of the category's trap checkboxes (the Switch only sends traps from selected categories).
Apply	Click Apply to save your changes to the Switch's run-time memory. The Switch loses these changes if it is turned off or loses power, so use the Save link on the top navigation panel to save your changes to the non-volatile memory when you are done configuring.
Cancel	Click Cancel to begin configuring this screen afresh.

63.9 Enable or Disable Sending of SNMP Traps on a Port

Click **SYSTEM > SNMP > SNMP Trap Port** to view the screen as shown. Use this screen to set whether a trap received on the ports would be sent to the SNMP manager.

Figure 280 SYSTEM > SNMP > SNMP Trap Port

Port	Active
*	<input type="checkbox"/>
1	<input checked="" type="checkbox"/>
2	<input checked="" type="checkbox"/>
3	<input checked="" type="checkbox"/>
4	<input checked="" type="checkbox"/>
5	<input checked="" type="checkbox"/>
6	<input checked="" type="checkbox"/>
7	<input checked="" type="checkbox"/>
8	<input checked="" type="checkbox"/>
9	<input checked="" type="checkbox"/>
10	<input checked="" type="checkbox"/>
11	<input checked="" type="checkbox"/>
12	<input checked="" type="checkbox"/>
13	<input checked="" type="checkbox"/>
14	<input checked="" type="checkbox"/>
15	<input checked="" type="checkbox"/>
16	<input checked="" type="checkbox"/>
17	<input checked="" type="checkbox"/>
18	<input checked="" type="checkbox"/>
19	<input checked="" type="checkbox"/>
20	<input checked="" type="checkbox"/>

The following table describes the labels in this screen.

Table 205 SYSTEM > SNMP > SNMP Trap Port

LABEL	DESCRIPTION
Option	Select the trap type you want to configure here.
Port	This field displays a port number.
*	Settings in this row apply to all ports. Use this row only if you want to make some of the settings the same for all ports. Use this row first to set the common settings and then make adjustments on a port-by-port basis. Changes in this row are copied to all the ports as soon as you make them.
Active	Select this checkbox to enable the trap type of SNMP traps on this port. Deselect this checkbox to disable the sending of SNMP traps on this port.

Table 205 SYSTEM > SNMP > SNMP Trap Port (continued)

LABEL	DESCRIPTION
Apply	Click Apply to save your changes to the Switch's run-time memory. The Switch loses these changes if it is turned off or loses power, so use the Save link on the top navigation panel to save your changes to the non-volatile memory when you are done configuring.
Cancel	Click Cancel to begin configuring this screen afresh.

CHAPTER 64

Port

64.1 What You Can Do

- Use the **Auto PD Recovery** screen ([Section 64.2 on page 388](#)) to turn on automatic PD recovery on the Switch and its Ethernet ports.
- Use the **Link Aggregation Status** screen ([Section 64.4 on page 390](#)) to view ports you have configured to be in the trunk group, ports that are currently transmitting data as one logical link in the trunk group and so on.
- Use the **Link Aggregation Setting** screen ([Section 64.5 on page 392](#)) to configure static link aggregation.
- Use the **Link Aggregation Control Protocol** screen ([Section 64.6 on page 393](#)) to enable Link Aggregation Control Protocol (LACP).
- Use the **PoE Status** screen ([Section 64.7 on page 395](#)) to view the current amount of power that PDs are receiving from the Switch.
- Use the **PoE Setup** screen ([Section 64.8 on page 397](#)) to set the PoE power management mode, priority levels, power-up mode and the maximum amount of power for the connected PDs.
- Use the **Port Setup** screen ([Section 64.9 on page 399](#)) to configure Switch port settings.

64.2 Auto PD Recovery

This screen lets you turn on automatic PD recovery on the Switch and its Ethernet ports. You can configure whether the Switch uses LLDP or ping to check current status of a connected PD. See [Section 29.2 on page 169](#) for more information.

To open this screen, click **PORT > Auto PD Recovery**.

Figure 281 PORT > Auto PD Recovery

Port	Active	Mode	Neighbor Name	Neighbor IP	Polling Interval (sec)	Polling Count	Action	Resume Polling Interval (sec)	PD Reboot Count
*	<input type="checkbox"/>	LLDP					Reboot-Alarm		
1	<input type="checkbox"/>	LLDP			20	3	Reboot-Alarm	600	1
2	<input type="checkbox"/>	LLDP	12A3_84		20	3	Reboot-Alarm	600	1
3	<input type="checkbox"/>	LLDP			20	3	Reboot-Alarm	600	1
4	<input type="checkbox"/>	LLDP			20	3	Reboot-Alarm	600	1
5	<input type="checkbox"/>	LLDP			20	3	Reboot-Alarm	600	1
6	<input type="checkbox"/>	LLDP			20	3	Reboot-Alarm	600	1
7	<input type="checkbox"/>	LLDP			20	3	Reboot-Alarm	600	1
8	<input type="checkbox"/>	LLDP			20	3	Reboot-Alarm	600	1

The following table describes the labels in this screen.

Table 206 PORT > Auto PD Recovery

LABEL	DESCRIPTION
Active	Select this option to enable Auto PD Recovery on the Switch.
Port	This field displays the index number of a port on the Switch.
*	Settings in this row apply to all ports. Use this row only if you want to make some settings the same for all ports. Use this row first to set the common settings and then make adjustments on a port-by-port basis. Changes in this row are copied to all the ports as soon as you make them.
Active	Set the switch to ON to enable Auto PD Recovery on the ports.
Mode	Select LLDP to have the Switch passively monitor current status of the connected PD by reading LLDP packets from the PD on the port. The Switch also sends out LLDP packets to the PD to update the Switch Neighbor table on the PD (see Section 60.3 on page 369 for details). Select Ping to have the Switch ping the IP address of the connected PD to test whether the PD is reachable or not. Select ONVIF to have the Switch passively monitor current status of the connected ONVIF-compatible PD by reading ONVIF packets from the PD on the port. Note: Make sure to enable the ONVIF feature on the Switch.
Neighbor Name	If Mode is set to LLDP , the system name of the connected PD displays automatically.
Neighbor IP	If Mode is set to Ping and the PD supports LLDP, the connected PD's IPv4 or IPv6 address to which the Switch sends ping requests will display automatically. If not, enter the IP address manually.
Test	Click Test to have the Switch test the connection by sending a ping request to the IP address.
Polling Interval (sec)	Specify the number of seconds the Switch waits for a response before sending another ping request. For example, the Switch will try to detect the PD status by performing ping requests every 20 seconds.

Table 206 PORT > Auto PD Recovery (continued)

LABEL	DESCRIPTION
Polling Count	<p>Specify how many times the Switch is to resend a ping request before considering the PD unreachable.</p> <p>For example, If there is no ping reply from the PD after the Polling Interval has elapsed, Polling Count starts from 1. After Polling Count reaches 3, the PD Health status LED will turn to red in the SUMMARY > Neighbor Detail screen (see Section 60.3 on page 369 for details). The Switch will then perform your choice in the Action field.</p>
Action	<p>Set the action to take when the connected PD has stopped responding.</p> <p>Select Reboot-Alarm to have the Switch turn OFF the power of the connected PD (the connecting port is detected as link-down) and turn it back ON again to restart the PD after sending an SNMP trap and generating a log message.</p> <p>When restarting, the PD entry disappears from the Switch's LLDP table and the PD Health status LED will turn to yellow in the SUAMMRY > Neighbor Detail screen (see Section 60.3 on page 369 for details).</p> <p>Select Alarm to have the Switch send an SNMP trap and generate a log message.</p>
Resume Polling Interval (sec)	Specify the number of seconds the Switch waits before monitoring the PD status again after it restarts the PD on the port.
PD Reboot Count	<p>Specify how many times the Switch attempts to restart the PD on the port.</p> <p>The PD Reboot Count will reset</p> <ul style="list-style-type: none"> • as soon as a ping is successful, • or when any modification to the Auto PD Recovery screen is applied, • or after restarting the Switch.
Resume Power Interval (sec)	Specify the number of seconds the Switch waits before supplying power to the connected PD again after it restarts the PD on the port.
Apply	Click Apply to save your changes to the Switch's run-time memory. The Switch loses these changes if it is turned off or loses power, so use the Save link on the top navigation panel to save your changes to the non-volatile memory when you are done configuring.
Cancel	Click this to reset the values in this screen to their last-saved values.

64.3 Link Aggregation

This section shows you how to logically aggregate physical links to form one logical, higher-bandwidth link.

Link aggregation (trunking) is the grouping of physical ports into one logical higher-capacity link. You may want to trunk ports if for example, it is cheaper to use multiple lower-speed links than to under-utilize a high-speed, but more costly, single-port link. However, the more ports you aggregate then the fewer available ports you have. A trunk group is one logical link containing multiple ports.

The beginning port of each trunk group must be physically connected to form a trunk group.

64.4 Link Aggregation Status

Use the **Link Aggregation Status** screen to view ports you have configured to be in the trunk group, ports that are currently transmitting data as one logical link in the trunk group and so on.

Click **PORT > Link Aggregation** in the navigation panel.

Figure 282 PORT > Link Aggregation

Link Aggregation Status		Link Aggregation Setting		Link Aggregation Control Protocol	
Group ID	Enabled Ports	Synchronized Ports	Aggregator ID	Criteria	Status
T1	-	-	-	src-dst-mac	-
T2	-	-	-	src-dst-mac	-
T3	-	-	-	src-dst-mac	-
T4	-	-	-	src-dst-mac	-
T5	-	-	-	src-dst-mac	-
T6	-	-	-	src-dst-mac	-
T7	-	-	-	src-dst-mac	-

The following table describes the labels in this screen.

Table 207 PORT > Link Aggregation

LABEL	DESCRIPTION
Group ID	This field displays the group ID to identify a trunk group, that is, one logical link containing multiple ports.
Enabled Ports	These are the ports you have configured in the Link Aggregation screen to be in the trunk group. The port numbers displays only when this trunk group is activated and there is a port belonging to this group.
Synchronized Ports	These are the ports that are currently transmitting data as one logical link in this trunk group.
Aggregator ID	Link Aggregator ID consists of the following: system priority, MAC address, key, port priority and port number. The ID displays only when there is a port belonging to this trunk group and LACP is also enabled for this group.
Criteria	This shows the outgoing traffic distribution algorithm used in this trunk group. Packets from the same source and/or to the same destination are sent over the same link within the trunk. src-mac means the Switch distributes traffic based on the packet's source MAC address. dst-mac means the Switch distributes traffic based on the packet's destination MAC address. src-dst-mac means the Switch distributes traffic based on a combination of the packet's source and destination MAC addresses. src-ip means the Switch distributes traffic based on the packet's source IP address. dst-ip means the Switch distributes traffic based on the packet's destination IP address. src-dst-ip means the Switch distributes traffic based on a combination of the packet's source and destination IP addresses.
Status	This field displays how these ports were added to the trunk group. It displays: <ul style="list-style-type: none"> Static – if the ports are configured as static members of a trunk group. LACP – if the ports are configured to join a trunk group through LACP.

64.5 Link Aggregation Setting

Use the **Link Aggregation Setting** screen to enable static link. Link aggregation (trunking) is the grouping of physical ports into one logical higher-capacity link. You may want to trunk ports if for example, it is cheaper to use multiple lower-speed links than to under-utilize a high-speed, but more costly, single-port link. However, the more ports you aggregate then the fewer available ports you have. A trunk group is one logical link containing multiple ports.

Click **PORT > Link Aggregation > Link Aggregation Setting** to display the screen shown next.

Figure 283 PORT > Link Aggregation > Link Aggregation Setting

Group ID	Active	Criteria
T1	<input checked="" type="checkbox"/>	src-dst-mac ▼
T2	<input type="checkbox"/>	src-dst-mac ▼
T3	<input type="checkbox"/>	src-dst-mac ▼
T4	<input type="checkbox"/>	src-dst-mac ▼
T5	<input type="checkbox"/>	src-dst-mac ▼
T6	<input type="checkbox"/>	src-dst-mac ▼
T7	<input type="checkbox"/>	src-dst-mac ▼

Port	Group
1	T1 ▼
2	None ▼
3	None ▼
4	None ▼
5	None ▼
6	None ▼
7	None ▼

The following table describes the labels in this screen.

Table 208 PORT > Link Aggregation > Link Aggregation Setting

LABEL	DESCRIPTION
Link Aggregation Setting	This is the only screen you need to configure to enable static link aggregation.
Group ID	The field identifies the link aggregation group, that is, one logical link containing multiple ports.
Active	Set this switch to on to activate a trunk group.

Table 208 PORT > Link Aggregation > Link Aggregation Setting (continued)

LABEL	DESCRIPTION
Criteria	<p>Select the outgoing traffic distribution type. Packets from the same source and/or to the same destination are sent over the same link within the trunk. By default, the Switch uses the src-dst-mac distribution type. If the Switch is behind a router, the packet's destination or source MAC address will be changed. In this case, set the Switch to distribute traffic based on its IP address to make sure port trunking can work properly.</p> <p>Select src-mac to distribute traffic based on the packet's source MAC address.</p> <p>Select dst-mac to distribute traffic based on the packet's destination MAC address.</p> <p>Select src-dst-mac to distribute traffic based on a combination of the packet's source and destination MAC addresses.</p> <p>Select src-ip to distribute traffic based on the packet's source IP address.</p> <p>Select dst-ip to distribute traffic based on the packet's destination IP address.</p> <p>Select src-dst-ip to distribute traffic based on a combination of the packet's source and destination IP addresses.</p>
Port	This field displays the port number.
Group	<p>Select the trunk group to which a port belongs.</p> <p>Note: When you enable the port security feature on the Switch and configure port security settings for a port, you cannot include the port in an active trunk group.</p>
Apply	Click Apply to save your changes to the Switch's run-time memory. The Switch loses these changes if it is turned off or loses power, so use the Save link on the top navigation panel to save your changes to the non-volatile memory when you are done configuring.
Cancel	Click Cancel to begin configuring this screen afresh.

64.6 Link Aggregation Control Protocol

When you enable LACP link aggregation on a port, the port can automatically negotiate with the ports at the remote end of a link to establish trunk groups. LACP also allows port redundancy, that is, if an operational port fails, then one of the "standby" ports become operational without user intervention.

Click **PORT > Link Aggregation > Link Aggregation Control Protocol** to display the screen shown next.

Figure 284 PORT > Link Aggregation > Link Aggregation Control Protocol

Status Link Aggregation Setting **Link Aggregation Control Protocol**

Active ON
 System Priority

Group ID	LACP Active
T1	<input type="checkbox"/>
T2	<input type="checkbox"/>
T3	<input type="checkbox"/>
T4	<input type="checkbox"/>
T5	<input type="checkbox"/>
T6	<input type="checkbox"/>
T7	<input type="checkbox"/>

Port	LACP Timeout
*	<input type="text" value="30"/> seconds
1	<input type="text" value="30"/> seconds
2	<input type="text" value="30"/> seconds
3	<input type="text" value="30"/> seconds
4	<input type="text" value="30"/> seconds
5	<input type="text" value="30"/> seconds
6	<input type="text" value="30"/> seconds
7	<input type="text" value="30"/> seconds

The following table describes the labels in this screen.

Table 209 PORT > Link Aggregation > Link Aggregation Control Protocol

LABEL	DESCRIPTION
Link Aggregation Control Protocol	Note: Do NOT configure this screen unless you want to enable dynamic link aggregation.
Active	Set this switch to ON to enable Link Aggregation Control Protocol (LACP).
System Priority	LACP system priority is a number between 1 and 65535. The switch with the lowest system priority (and lowest port number if system priority is the same) becomes the LACP "server". The LACP "server" controls the operation of LACP setup. Enter a number to set the priority of an active port using Link Aggregation Control Protocol (LACP). The smaller the number, the higher the priority level.
Group ID	The field identifies the link aggregation group, that is, one logical link containing multiple ports.
LACP Active	Select this option to enable LACP for a trunk.

Table 209 PORT > Link Aggregation > Link Aggregation Control Protocol (continued)

LABEL	DESCRIPTION
Port	This field displays the port number.
*	Settings in this row apply to all ports. Use this row only if you want to make some settings the same for all ports. Use this row first to set the common settings and then make adjustments on a port-by-port basis. Note: Changes in this row are copied to all the ports as soon as you make them.
LACP Timeout	Timeout is the time interval between the individual port exchanges of LACP packets in order to check that the peer port in the trunk group is still up. If a port does not respond after three tries, then it is deemed to be "down" and is removed from the trunk. Set a short timeout (one second) for busy trunked links to ensure that disabled ports are removed from the trunk group as soon as possible. Select either 1 second or 30 seconds.
Apply	Click Apply to save your changes to the Switch's run-time memory. The Switch loses these changes if it is turned off or loses power, so use the Save link on the top navigation panel to save your changes to the non-volatile memory when you are done configuring.
Cancel	Click Cancel to begin configuring this screen afresh.

64.7 PoE Status

To view the current amount of power that PDs are receiving from the Switch, click **PORT > PoE Setup**. See [Section 33.1 on page 206](#) for more information on PoE status and setup.

Figure 285 PORT > PoE Setup

PoE Status		PoE Setup				
PoE Mode	Consumption					
Total Power (W)	375.0					
PoE Usage (%)	0					
Consuming Power (W)	0.0					
Allocated Power (W)	NA					
Remaining Power (W)	375.0					
Port	State	Class	Priority	Power-Up	Consuming Power (W)	Max Power (W)
1	Enable	0	Low	802.3at	0.0	-
2	Enable	0	Low	802.3at	0.0	-
3	Enable	0	Low	802.3at	0.0	-
4	Enable	0	Low	802.3at	0.0	-
5	Enable	0	Low	802.3at	0.0	-
6	Enable	0	Low	802.3at	0.0	-
7	Enable	0	Low	802.3at	0.0	-

The following table describes the labels in this screen.

Table 210 Port > PoE Setup

LABEL	DESCRIPTION
PoE Mode	This field displays the power management mode used by the Switch, whether it is in Classification or Consumption mode.
Total Power (W)	This field displays the total power the Switch can provide to the connected PoE-enabled devices on the PoE ports.

Table 210 Port > PoE Setup (continued)

LABEL	DESCRIPTION
PoE Usage (%)	<p>This field displays the amount of power currently being supplied to connected PoE devices (PDs) as a percentage of the total PoE power the Switch can supply.</p> <p>When PoE usage reaches 100%, the Switch will shut down PDs one-by-one according to the PD priority which you configured in Port > PoE Setup > PoE Setup.</p>
Consuming Power (W)	<p>This field displays the amount of power the Switch is currently supplying to the connected PoE-enabled devices.</p>
Allocated Power (W)	<p>This field displays the total amount of power the Switch (in classification mode) has reserved for PoE after negotiating with the connected PoE devices. It shows NA when the Switch is in consumption mode.</p> <p>Consuming Power (W) can be less than or equal but not more than the Allocated Power (W).</p>
Remaining Power (W)	<p>This field displays the amount of power the Switch can still provide for PoE.</p> <p>Note: The Switch must have at least 16 W of remaining power in order to supply power to a PoE device, even if the PoE device needs less than 16 W.</p>
Port	<p>This is the port index number.</p>
State	<p>This field shows which ports can receive power from the Switch. You can set this in Section 64.8 on page 397.</p> <ul style="list-style-type: none"> • Disable – The PD connected to this port cannot get power supply. • Enable – The PD connected to this port can receive power.
Class	<p>This shows the power classification of the PD. Each PD has a specified maximum power that fall under one of the classes.</p> <p>The Class is a number from 0 to 6, where each value represents the range of power that the Switch provides to the PD. The power ranges in PoE standards are as follows.</p> <ul style="list-style-type: none"> • Class 0 – default: 0.44 W to 15.4 W. • Class 1 – default: 0.44 W to 4 W. • Class 2 – default: 0.44 W to 7 W. • Class 3 – default: 0.44 W to 15.4 W. • Class 4 – default: 0.44 W to 30 W. • Class 5 – default: 0.44 W to 45 W. • Class 6 – default: 0.44 W to 60 W. <p>Note: You can extend or set a limit on the maximum power the connected PD can use on a port in Port > PoE Setup > PoE Setup.</p>
Priority	<p>When the total power requested by the PDs exceeds the total PoE power budget on the Switch, you can set the PD priority to allow the Switch to provide power to ports with higher priority first.</p> <ul style="list-style-type: none"> • Critical has the highest priority. • High has the Switch assign power to the port after all critical priority ports are served. • Low has the Switch assign power to the port after all critical and high priority ports are served.
Power-Up	<p>This field displays the PoE standard the Switch uses to provide power on this port.</p>
Consuming Power (W)	<p>This field displays the current amount of power consumed by the PD from the Switch on this port.</p>
Max Power (W)	<p>This field displays the maximum amount of power the PD could use from the Switch on this port.</p>

64.8 PoE Setup

Use this screen to set the PoE power management mode, priority levels, power-up mode and the maximum amount of power for the connected PDs.

Click **PORT > PoE Setup > PoE Setup**, the following screen opens.

Figure 286 PORT > PoE Setup > PoE Setup

Port	Active	Priority	Power-Up	Max Power (mW)	LLDP Power Via MDI
*	<input type="checkbox"/>	Critical	802.3af		<input type="checkbox"/>
1	<input checked="" type="checkbox"/>	Low	802.3af		<input checked="" type="checkbox"/>
2	<input checked="" type="checkbox"/>	Low	802.3af		<input checked="" type="checkbox"/>
3	<input checked="" type="checkbox"/>	Low	802.3af		<input checked="" type="checkbox"/>
4	<input checked="" type="checkbox"/>	Low	802.3af		<input checked="" type="checkbox"/>
5	<input checked="" type="checkbox"/>	Low	802.3af		<input checked="" type="checkbox"/>
6	<input checked="" type="checkbox"/>	Low	802.3af		<input checked="" type="checkbox"/>
7	<input checked="" type="checkbox"/>	Low	802.3af		<input checked="" type="checkbox"/>

The following table describes the labels in this screen.

Table 211 PORT > PoE Setup > PoE Setup

LABEL	DESCRIPTION
PoE Mode	Select the power management mode you want the Switch to use. <ul style="list-style-type: none"> Classification – Select this if you want the Switch to reserve the maximum power for each PD according to the PD’s power class and priority level. If the total power supply runs out, PDs with lower priority do not get power to function. In this mode, the maximum power is reserved based on what you configure in Max Power or the standard power limit for each class. Consumption – Select this if you want the Switch to supply the actual power that the PD needs. The Switch also allocates power based on a port’s Max Power and the PD’s power class and priority level. The Switch puts a limit on the maximum amount of power the PD can request and use. In this mode, the default maximum power that can be delivered to the PD is 33 W (IEEE 802.3at Class 4) or 22 W (IEEE 802.3af Classes 0 to 3).
Continuous PoE	Select ON to guarantee continuous power supply to the connected PDs while the Switch is restarting after a warm reboot. The Switch will NOT perform a power cycle on the connected PDs. If you do a cold reboot, the Switch also restarts the connected PDs.
Port	This is the port index number.
*	Settings in this row apply to all ports. Use this row only if you want to make some settings the same for all ports. Use this row first to set the common settings and then make adjustments on a port-by-port basis. Changes in this row are copied to all the ports as soon as you make them.
Active	Select this to provide power to a PD connected to the port. If left unchecked, the PD connected to the port cannot receive power from the Switch.

Table 211 PORT > PoE Setup > PoE Setup (continued)

LABEL	DESCRIPTION
Priority	<p>When the total power requested by the PDs exceeds the total PoE power budget on the Switch, you can set the PD priority to allow the Switch to provide power to ports with higher priority.</p> <p>Select Critical to give the highest PD priority on the port.</p> <p>Select High to set the Switch to assign the remaining power to the port after all critical priority ports are served.</p> <p>Select Low to set the Switch to assign the remaining power to the port after all critical and high priority ports are served.</p>
Power-Up	<p>Set how the Switch provides power to a connected PD at power-up.</p> <p>802.3af – the Switch follows the IEEE 802.3af Power over Ethernet standard to supply power to the connected PDs during power-up.</p> <p>Legacy – the Switch can provide power to the connected PDs that require high inrush currents at power-up. Inrush current is the maximum, instantaneous input current drawn by the PD when first turned on.</p> <p>Pre-802.3at – the Switch initially offers power on the port according to the IEEE 802.3af standard, and then switches to support the IEEE 802.3at standard within 75 milliseconds after a PD is connected to the port. Select this option if the Switch is performing 2-event Layer-1 classification (PoE+ hardware classification) or the connected PD is NOT performing Layer 2 power classification using Link Layer Discovery Protocol (LLDP).</p> <p>802.3at – the Switch supports the IEEE 802.3at High Power over Ethernet standard and can supply power of up to 30 W per Ethernet port. IEEE 802.3at is also known as PoE+ or PoE Plus. An IEEE 802.3at compatible device is referred to as Type 2. Power Class 4 (High Power) can only be used by Type 2 devices. If the connected PD requires a Class 4 current when it is turned on, it will be powered up in this mode.</p> <p>Force-802.3at – the Switch offers power of up to 33 W on the port without performing PoE hardware classification. Select this option if the connected PD does not comply with any PoE standard and requests power higher than a standard power limit.</p>
Max Power (mW)	Specify the maximum amount of power the PD could use from the Switch on this port. If you leave this field blank, the Switch refers to the standard or default maximum power for each class.
LLDP Power Via MDI	<p>Select this to have the Switch negotiate PoE power with the PD connected to the port by transmitting LLDP Power Via MDI TLV frames. This helps the Switch allocate less power to the PD on this port. The connected PD must be able to request PoE power through LLDP.</p> <p>The Power Via MDI TLV allows PoE devices to advertise and discover the MDI power support capabilities of the sending port on the remote device.</p> <ul style="list-style-type: none"> • Port Class • MDI Supported • MDI Enabled • Pair Controllable • PSE Power Pairs • Power Class
Apply	Click Apply to save your changes to the Switch's run-time memory. The Switch loses these changes if it is turned off or loses power, so use the Save link on the top navigation panel to save your changes to the non-volatile memory when you are done configuring.
Cancel	Click Cancel to begin configuring this screen afresh.

64.9 Port Setup

Use this screen to configure Switch port settings. Click **PORT > Port Setup** in the navigation panel to display the configuration screen.

Figure 287 PORT > Port Setup

Port	Active	Name	Speed / Duplex	Extend Range	Flow Control	802.1p Priority
*	<input type="checkbox"/>	<input type="text"/>	Auto	<input type="checkbox"/>	<input type="checkbox"/>	0
1	<input checked="" type="checkbox"/>	<input type="text"/>	Auto	<input type="checkbox"/>	<input type="checkbox"/>	0
2	<input checked="" type="checkbox"/>	<input type="text"/>	Auto	<input type="checkbox"/>	<input type="checkbox"/>	0
3	<input checked="" type="checkbox"/>	<input type="text"/>	Auto	<input type="checkbox"/>	<input type="checkbox"/>	0
4	<input checked="" type="checkbox"/>	<input type="text"/>	Auto	<input type="checkbox"/>	<input type="checkbox"/>	0
5	<input checked="" type="checkbox"/>	<input type="text"/>	Auto	<input type="checkbox"/>	<input type="checkbox"/>	0
6	<input checked="" type="checkbox"/>	<input type="text"/>	Auto	<input type="checkbox"/>	<input type="checkbox"/>	0
7	<input checked="" type="checkbox"/>	<input type="text"/>	Auto	<input type="checkbox"/>	<input type="checkbox"/>	0
8	<input checked="" type="checkbox"/>	<input type="text"/>	Auto	<input type="checkbox"/>	<input type="checkbox"/>	0
9	<input checked="" type="checkbox"/>	<input type="text"/>	Auto	<input type="checkbox"/>	<input type="checkbox"/>	0
10	<input checked="" type="checkbox"/>	<input type="text"/>	Auto	<input type="checkbox"/>	<input type="checkbox"/>	0

The following table describes the labels in this screen.

Table 212 PORT > Port Setup

LABEL	DESCRIPTION
Port	This is the port index number.
*	<p>Settings in this row apply to all ports.</p> <p>Use this row only if you want to make some settings the same for all ports. Use this row first to set the common settings and then make adjustments on a port-by-port basis.</p> <p>Note: Changes in this row are copied to all the ports as soon as you make them.</p>
Active	Select this checkbox to enable a port. The factory default for all ports is enabled. A port must be enabled for data transmission to occur.
Name	<p>Enter a descriptive name that identifies this port. You can enter up to 128 alpha-numerical characters.</p> <p>Note: Due to space limitation, the port name may be truncated in some Web Configurator screens.</p>
Speed/Duplex	<p>Select the speed and the duplex mode of the Ethernet connection on this port. Choices are Auto, 10-an (10M/auto-negotiation), 10M/Half Duplex, 10M/Full Duplex, 100-an (100M/auto-negotiation), 100M/Half Duplex, 100M/Full Duplex and 1G/Full Duplex (Gigabit connections only).</p> <p>Selecting Auto (auto-negotiation) allows one port to negotiate with a peer port automatically to obtain the connection speed and duplex mode that both ends support. When auto-negotiation is turned on, a port on the Switch negotiates with the peer automatically to determine the connection speed and duplex mode. If the peer port does not support auto-negotiation or turns off this feature, the Switch determines the connection speed by detecting the signal on the cable and using half duplex mode. When the Switch's auto-negotiation is turned off, a port uses the pre-configured speed and duplex mode when making a connection, therefore requiring you to make sure that the settings of the peer port are the same in order to connect.</p>

Table 212 PORT > Port Setup (continued)

LABEL	DESCRIPTION
Extend Range	<p>Select this checkbox to extend the PoE range up to 250 meters.</p> <p>After you enable this feature, the port will transfer data at a rate up to 10M in full duplex mode. If a PD is connected to the port, the Switch follows the IEEE 802.3at PoE+ standard to supply power to the connected PD during power-up.</p> <p>Note: Maximum PoE power that can be supplied to a PD at 250 m is 15 W.</p> <p>Note: If you enable extended range on a port after the connected PD starts up completely, you must disable PoE and enable it again or disconnect and reconnect the cable to the port for extended mode to take effect.</p> <p>Note: The port speed and duplex mode you previously configured will be applied automatically when the extend range feature is disabled.</p>
Flow Control	<p>A concentration of traffic on a port decreases port bandwidth and overflows buffer memory causing packet discards and frame losses. Flow Control is used to regulate transmission of signals to match the bandwidth of the receiving port.</p> <p>The Switch uses IEEE802.3x flow control in full duplex mode and backpressure flow control in half duplex mode.</p> <p>IEEE802.3x flow control is used in full duplex mode to send a pause signal to the sending port, causing it to temporarily stop sending signals when the receiving port memory buffers fill.</p> <p>Back Pressure flow control is typically used in half duplex mode to send a "collision" signal to the sending port (mimicking a state of packet collision) causing the sending port to temporarily stop sending signals and resend later. Select Flow Control to enable it.</p>
802.1p Priority	<p>This priority value is added to incoming frames without a (802.1p) tag. See Priority Queue Assignment in Table 210 on page 395 for more information.</p>
Apply	<p>Click Apply to save your changes to the Switch's run-time memory. The Switch loses these changes if it is turned off or loses power, so use the Save link on the top navigation panel to save your changes to the non-volatile memory when you are done configuring.</p>
Cancel	<p>Click Cancel to begin configuring this screen afresh.</p>

CHAPTER 65

Switching

65.1 Loop Guard

This section shows you how to configure the Switch to guard against loops on the edge of your network.

Loop guard allows you to configure the Switch to shut down a port if it detects that packets sent out on that port loop back to the Switch. While you can use Spanning Tree Protocol (STP) to prevent loops in the core of your network, STP cannot prevent loops that occur on the edge of your network. See [Loop Guard Overview](#) for more information.

Click **SWITCHING** > **Loop Guard** in the navigation panel to display the screen as shown.

Note: The loop guard feature cannot be enabled on the ports that have Spanning Tree Protocol (RSTP) enabled.

Figure 288 SWITCHING > Loop Guard

The screenshot shows the 'Loop Guard' configuration interface. At the top, there is a title 'Loop Guard' and a toggle switch for 'Active' which is currently set to 'OFF'. Below this is a table with two columns: 'Port' and 'Active'. The 'Port' column lists ports from 1 to 7, with an asterisk (*) above the first row. The 'Active' column contains checkboxes for each port, all of which are currently unchecked. At the bottom of the interface, there are two buttons: 'Apply' (highlighted in green) and 'Cancel'.

Port	Active
*	<input type="checkbox"/>
1	<input type="checkbox"/>
2	<input type="checkbox"/>
3	<input type="checkbox"/>
4	<input type="checkbox"/>
5	<input type="checkbox"/>
6	<input type="checkbox"/>
7	<input type="checkbox"/>

The following table describes the labels in this screen.

Table 213 SWITCHING > Loop Guard

LABEL	DESCRIPTION
Active	Set the switch to ON to enable loop guard on the Switch. The Switch generates syslog, internal log messages as well as SNMP traps when it shuts down a port through the loop guard feature.
Port	This field displays the port number.
*	Settings in this row apply to all ports. Use this row only if you want to make some settings the same for all ports. Use this row first to set the common settings and then make adjustments on a port-by-port basis. Note: Changes in this row are copied to all the ports as soon as you make them.
Active	Select this checkbox to enable the loop guard feature on this port. The Switch sends probe packets from this port to check if the switch it is connected to is in loop state. If the switch that this port is connected is in loop state the Switch will shut down this port. Clear this checkbox to disable the loop guard feature.
Apply	Click Apply to save your changes to the Switch's run-time memory. The Switch loses these changes if it is turned off or loses power, so use the Save link on the top navigation panel to save your changes to the non-volatile memory when you are done configuring.
Cancel	Click Cancel to begin configuring this screen afresh.

65.2 ONVIF

When ONVIF (Open Network Video Interface Forum) is enabled and configured, the Switch can obtain the ONVIF security device's information such as system name and IP address. This lets you to know which IP-based security products, for example IP camera or NVR (network video recorder), is connected to the Switch.

Use the **ONVIF** screen to enable the ONVIF protocol on the Switch.

Figure 289 SWITCHING > ONVIF

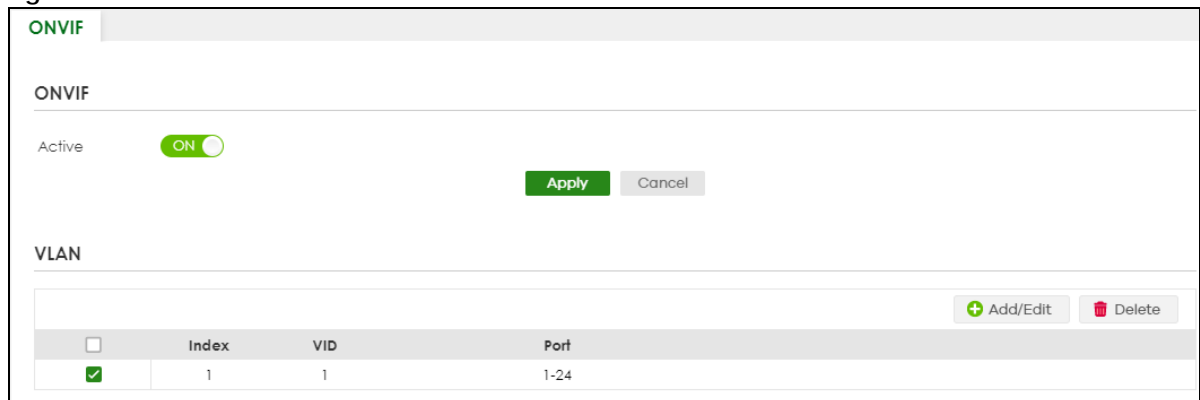

The following table describes the labels in this screen.

Table 214 SWITCHING > ONVIF

LABEL	DESCRIPTION
ONVIF	
Active	Select Active to allow this Switch to send ONVIF packets to discover or scan for ONVIF-compatible IP-based security devices connected to its ports. Make sure to enter the port numbers in Port to allow discovery of ONVIF-compatible devices.
Apply	Click Apply to save your changes to the Switch's run-time memory. The Switch loses these changes if it is turned off or loses power, so use the Save link on the top navigation panel to save your changes to the non-volatile memory when you are done configuring.
Cancel	Click this to reset the values in this screen to their last-saved values.
VLAN	
	Select an entry's checkbox to select a specific entry. Otherwise, select the checkbox in the table heading row to select all entries.
Index	This is the index number of the ONVIF entry in the table.
VID	This field displays the VLAN to which the ports belong.
Port	This field displays the ports to which the Switch applies the settings.
Add/Edit	Click this button to create new or configure ONVIF settings for the VLAN port.
Delete	Click this button to remove the ONVIF settings for the VLAN port.

65.3 VLAN

This section shows you how to configure 802.1Q tagged and port-based VLANs.

65.3.1 What You Can Do

- Use the **VLAN Status** screen ([Section 65.4 on page 403](#)) to view and search all VLAN groups.
- Use the **VLAN Detail** screen ([Section 65.4.1 on page 404](#)) to view detailed port settings and status of the VLAN group.
- Use the **Static VLAN** screen ([Section 65.5 on page 405](#)) to configure and view 802.1Q VLAN parameters for the Switch.
- Use the **VLAN Port Setting** screen ([Section 65.6 on page 407](#)) to configure the static VLAN (IEEE 802.1Q) settings on a port.

See [Section 48.1.2 on page 257](#) for more information on VLAN.

65.4 VLAN Status

Use this screen to view and search all static VLAN groups. Click **SWITCHING > VLAN** from the navigation panel to display the **VLAN Status** screen as shown next.

Figure 290 SWITCHING > VLAN

Index	VID	Name	Tagged Port	Untagged Port	Elapsed Time	Status
1	1	1		1-54	7:59:18	Static
2	100	VLAN100			0:00:05	Static

The following table describes the labels in this screen.

Table 215 SWITCHING > VLAN

LABEL	DESCRIPTION
VLAN Search by VID	Enter an existing VLAN ID numbers (separated by a comma) and click Search to display only the specified VLANs in the list below. Leave this field blank and click Search to display all VLANs configured on the Switch.
The Number of VLAN	This is the number of VLANs configured on the Switch.
The Number of Search Results	This is the number of VLANs that match the searching criteria and display in the list below. This field displays only when you use the Search button to look for certain VLANs.
Index	This is the VLAN index number. Click on an index number to view more VLAN details.
VID	This is the VLAN identification number that was configured in the corresponding VLAN configuration screen.
Name	This fields shows the descriptive name of the VLAN.
Tagged Port	This field shows the tagged ports that are participating in the VLAN.
Untagged Port	This field shows the untagged ports that are participating in the VLAN.
Elapsed Time	This field shows how long it has been since a normal VLAN was registered or a static VLAN was set up.
Status	This field shows how this VLAN was added to the Switch. Static: added as a permanent entry.
Page	Click the forward or back icon to show the previous or next screen if all status information cannot be seen in one screen. Or enter the page number.

65.4.1 VLAN Detail

Use this screen to view detailed port settings and status of the static VLAN group. Click on an index number in the **VLAN Status** screen to display VLAN details.

Figure 291 SWITCHING > VLAN > VLAN Status Details

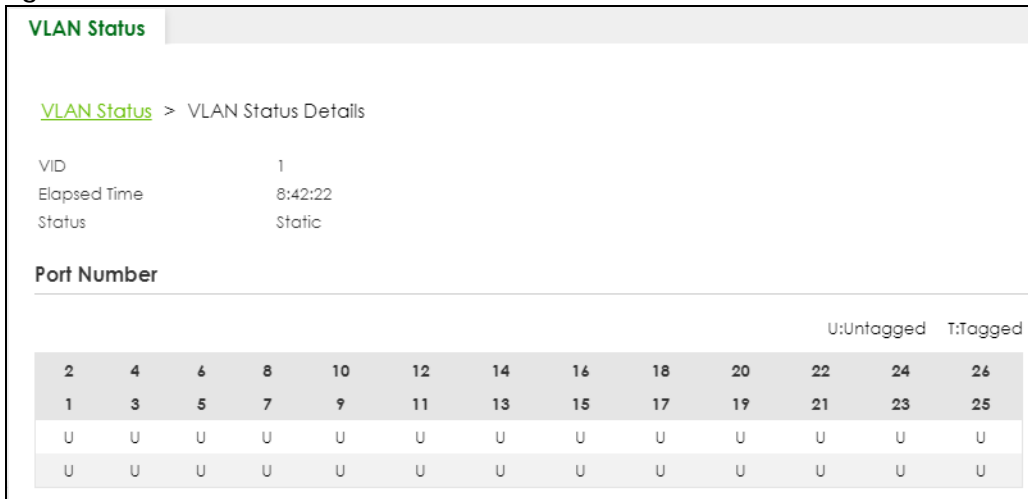

The following table describes the labels in this screen.

Table 216 SWITCHING > VLAN > VLAN Status Detail

LABEL	DESCRIPTION
VLAN Status	Click this to go to the VLAN Status screen.
VID	This is the VLAN identification number that was configured in the corresponding VLAN configuration screen.
Elapsed Time	This field shows how long it has been since a normal VLAN was registered or a static VLAN was set up.
Status	This field shows how this VLAN was added to the Switch. Static: added as a permanent entry.
Port Number	This column displays the ports that are participating in a VLAN. A tagged port is marked as T , an untagged port is marked as U and ports not participating in a VLAN are marked as “-”.

65.5 Static VLAN

Use this screen to view static VLAN status for the Switch. Click **SWITCHING > VLAN > Static VLAN** to display the screen as shown next.

Figure 292 SWITCHING > VLAN > Static VLAN

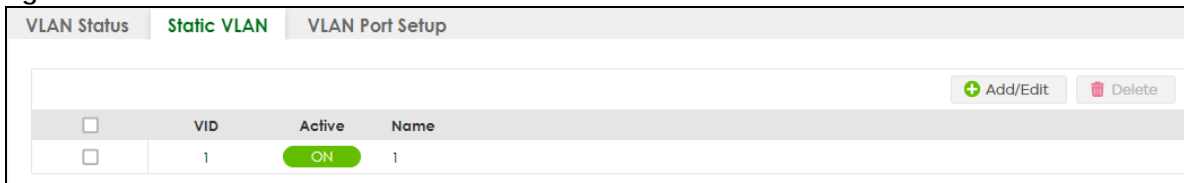

The following table describes the related labels in this screen.

Table 217 SWITCHING > VLAN > Static VLAN

LABEL	DESCRIPTION
	Select an entry's checkbox to select a specific entry. Otherwise, select the checkbox in the table heading row to select all entries.
VID	This field displays the ID number of the VLAN group. Click the number to edit the VLAN settings.
Active	This field indicates whether the VLAN settings are enabled (ON) or disabled (OFF).
Name	This field displays the descriptive name for this VLAN group.
Add/Edit	Click this button to create a new or configure static VLAN.
Delete	Click this button to remove the static VLAN.

Click **Add** or **Edit** button to open the following screen. Use this screen to configure a static VLAN for the Switch.

Figure 293 SWITCHING > VLAN > VLAN Setup > Static VLAN > Add/Edit

The following table describes the related labels in this screen.

Table 218 SWITCHING > VLAN > Static VLAN > Add/Edit Static VLAN

LABEL	DESCRIPTION
Active	Select this switch to activate the VLAN settings.
Name	Enter a descriptive name for the VLAN group for identification purposes. This name consists of up to 64 printable characters. Spaces are allowed.
VLAN Group ID	Enter the VLAN ID for this static entry; the valid range is between 1 and 4094.
Port	The port number identifies the port you are configuring.

Table 218 SWITCHING > VLAN > Static VLAN > Add/Edit Static VLAN (continued)

LABEL	DESCRIPTION
*	Settings in this row apply to all ports. Use this row only if you want to make some settings the same for all ports. Use this row first to set the common settings and then make adjustments on a port-by-port basis. Note: Changes in this row are copied to all the ports as soon as you make them.
Control	Select Normal for the port to dynamically join this VLAN group. This is the default selection. Select Fixed for the port to be a permanent member of this VLAN group. Select Forbidden if you want to prohibit the port from joining this VLAN group.
Tagging	Select TX Tagging if you want outgoing traffic to contain this VLAN tag. Otherwise, to ensure that VLAN-unaware devices (such as computers and hubs) can receive frames properly, clear the TX Tagging checkbox to set the Switch to remove VLAN tags before sending.
Apply	Click Apply to save your changes to the Switch's run-time memory. The Switch loses these changes if it is turned off or loses power, so use the Save link on the top navigation panel to save your changes to the non-volatile memory when you are done configuring.
Clear	Click Clear to reset the fields to the factory defaults.
Cancel	Click Cancel to change the fields back to their last saved values.

65.6 VLAN Port Setup

Use this screen to configure the static VLAN (IEEE 802.1Q) settings on a port. Click the **VLAN Port Setup** tab in the **VLAN** screen.

Figure 294 SWITCHING > VLAN > VLAN Port Setup

Port	Ingress Check	PVID	Acceptable Frame Type	VLAN Trunking	Isolation
*	<input type="checkbox"/>	<input type="text"/>	All <input type="text"/>	<input type="checkbox"/>	<input type="checkbox"/>
1	<input type="checkbox"/>	1 <input type="text"/>	All <input type="text"/>	<input type="checkbox"/>	<input type="checkbox"/>
2	<input type="checkbox"/>	1 <input type="text"/>	All <input type="text"/>	<input type="checkbox"/>	<input type="checkbox"/>
3	<input type="checkbox"/>	1 <input type="text"/>	All <input type="text"/>	<input type="checkbox"/>	<input type="checkbox"/>
4	<input type="checkbox"/>	1 <input type="text"/>	All <input type="text"/>	<input type="checkbox"/>	<input type="checkbox"/>
5	<input type="checkbox"/>	1 <input type="text"/>	All <input type="text"/>	<input type="checkbox"/>	<input type="checkbox"/>
6	<input type="checkbox"/>	1 <input type="text"/>	All <input type="text"/>	<input type="checkbox"/>	<input type="checkbox"/>
7	<input type="checkbox"/>	1 <input type="text"/>	All <input type="text"/>	<input type="checkbox"/>	<input type="checkbox"/>

The following table describes the labels in this screen.

Table 219 SWITCHING > VLAN > VLAN Port Setup

LABEL	DESCRIPTION
Port	This field displays the port number.
*	<p>Settings in this row apply to all ports.</p> <p>Use this row only if you want to make some settings the same for all ports. Use this row first to set the common settings and then make adjustments on a port-by-port basis.</p> <p>Note: Changes in this row are copied to all the ports as soon as you make them.</p>
Ingress Check	<p>If this checkbox is selected, the Switch discards incoming frames on a port for VLANs that do not include this port in its member set.</p> <p>Clear this checkbox to disable ingress filtering.</p>
PVID	<p>A PVID (Port VLAN ID) is a tag that adds to incoming untagged frames received on a port so that the frames are forwarded to the VLAN group that the tag defines.</p> <p>Enter a number between 1 and 4094 as the port VLAN ID.</p>
Acceptable Frame Type	<p>Specify the type of frames allowed on a port. Choices are All, Tag Only and Untag Only.</p> <p>Select All from the drop-down list box to accept all untagged or tagged frames on this port. This is the default setting.</p> <p>Select Tag Only to accept only tagged frames on this port. All untagged frames will be dropped.</p> <p>Select Untag Only to accept only untagged frames on this port. All tagged frames will be dropped.</p>
VLAN Trunking	<p>Enable VLAN Trunking on ports connected to other switches or routers (but not ports directly connected to end users) to allow frames belonging to unknown VLAN groups to pass through the Switch.</p>
Isolation	<p>Select this to allow this port to communicate only with the CPU management port and the ports on which the isolation feature is NOT enabled.</p>
Apply	<p>Click Apply to save your changes to the Switch's run-time memory. The Switch loses these changes if it is turned off or loses power, so use the Save link on the top navigation panel to save your changes to the non-volatile memory when you are done configuring.</p>
Cancel	<p>Click Cancel to begin configuring this screen afresh.</p>

CHAPTER 66

Security

66.1 Access Control

This section describes how to control access to the Switch. See [Access Control Overview](#) for more information.

66.1.1 What You Can Do

- Use the **Service Access Control** screen ([Section 66.2 on page 409](#)) to decide what services you may use to access the Switch.
- Use the **Remote Management** screens ([Section 66.3 on page 410](#)) to specify a group of one or more “trusted computers” from which an administrator may use a service to manage the Switch.
- Use the **Storm Control** screen ([Section 66.6 on page 413](#)) to limit the number of broadcast, multicast and destination lookup failure (DLF) packets the Switch receives per second on the ports.

66.2 Service Access Control Screen

Service Access Control allows you to decide what services you may use to access the Switch. You may also change the default service port and configure “trusted computers” for each service in the **Remote Management** screen (discussed later). Click **SECURITY > Access Control > Service Access Control** to view the screen as shown.

Figure 295 SECURITY > Access Control > Service Access Control

Services	Active	Service Port	Timeout	Login Timeout
Console			5 Minutes	
Telnet	<input type="radio"/> OFF	23	5 Minutes	150 Seconds
SSH	<input checked="" type="radio"/> ON	22		
FTP	<input checked="" type="radio"/> ON	21	5 Minutes	
HTTP	<input checked="" type="radio"/> ON	80	5 Minutes	
HTTPS	<input checked="" type="radio"/> ON	443		
ICMP	<input checked="" type="radio"/> ON			
SNMP	<input type="radio"/> OFF			

The following table describes the fields in this screen.

Table 220 SECURITY > Access Control > Service Access Control

LABEL	DESCRIPTION
Services	Services you may use to access the Switch are listed here.
Active	Select this option for the corresponding services that you want to allow to access the Switch.
Service Port	For Telnet, SSH, FTP, HTTP or HTTPS services, you may change the default service port by typing the new port number in the Service Port field. If you change the default port number then you will have to let people (who wish to use the service) know the new port number for that service.
Timeout	Enter how many minutes (from 1 to 255) a management session can be left idle before the session times out. After it times out you have to log in with your password again. Very long idle timeouts may have security risks.
Login Timeout	<p>The Telnet or SSH server do not allow multiple user logins at the same time. Enter how many seconds (from 30 to 300 seconds) a login session times out. After it times out you have to start the login session again. Very long login session timeouts may have security risks.</p> <p>For example, if User A attempts to connect to the Switch (through SSH), but during the login stage, do not enter the user name and/or password, User B cannot connect to the Switch (through SSH) before the Login Timeout for User A expires (default 150 seconds).</p>
Apply	Click Apply to save your changes to the Switch's run-time memory. The Switch loses these changes if it is turned off or loses power, so use the Save link on the top navigation panel to save your changes to the non-volatile memory when you are done configuring.
Cancel	Click Cancel to begin configuring this screen afresh.

66.3 Remote Management (IPv4)

Use this screen to specify a group of one or more "trusted computers using IPv4 addresses" from which an administrator may use a service to manage the Switch.

Click **SECURITY > Access Control > Remote Management IPv4** to view the screen as shown next.

Figure 296 SECURITY > Access Control > Remote Management IPv4

Remote Management IPv4
Remote Management IPv6

Secured Client Setup

Entry	Active	Start Address	End Address	Telnet	FTP	HTTP	ICMP	SNMP	SSH	HTTPS
1	<input checked="" type="radio"/>	0.0.0.0	0.0.0.0	<input checked="" type="checkbox"/>	<input checked="" type="checkbox"/>	<input checked="" type="checkbox"/>	<input checked="" type="checkbox"/>	<input checked="" type="checkbox"/>	<input checked="" type="checkbox"/>	<input checked="" type="checkbox"/>
2	<input type="radio"/>	0.0.0.0	0.0.0.0	<input type="checkbox"/>	<input type="checkbox"/>	<input type="checkbox"/>	<input type="checkbox"/>	<input type="checkbox"/>	<input type="checkbox"/>	<input type="checkbox"/>
3	<input type="radio"/>	0.0.0.0	0.0.0.0	<input type="checkbox"/>	<input type="checkbox"/>	<input type="checkbox"/>	<input type="checkbox"/>	<input type="checkbox"/>	<input type="checkbox"/>	<input type="checkbox"/>
4	<input type="radio"/>	0.0.0.0	0.0.0.0	<input type="checkbox"/>	<input type="checkbox"/>	<input type="checkbox"/>	<input type="checkbox"/>	<input type="checkbox"/>	<input type="checkbox"/>	<input type="checkbox"/>
5	<input type="radio"/>	0.0.0.0	0.0.0.0	<input type="checkbox"/>	<input type="checkbox"/>	<input type="checkbox"/>	<input type="checkbox"/>	<input type="checkbox"/>	<input type="checkbox"/>	<input type="checkbox"/>
6	<input type="radio"/>	0.0.0.0	0.0.0.0	<input type="checkbox"/>	<input type="checkbox"/>	<input type="checkbox"/>	<input type="checkbox"/>	<input type="checkbox"/>	<input type="checkbox"/>	<input type="checkbox"/>
7	<input type="radio"/>	0.0.0.0	0.0.0.0	<input type="checkbox"/>	<input type="checkbox"/>	<input type="checkbox"/>	<input type="checkbox"/>	<input type="checkbox"/>	<input type="checkbox"/>	<input type="checkbox"/>
8	<input type="radio"/>	0.0.0.0	0.0.0.0	<input type="checkbox"/>	<input type="checkbox"/>	<input type="checkbox"/>	<input type="checkbox"/>	<input type="checkbox"/>	<input type="checkbox"/>	<input type="checkbox"/>
9	<input type="radio"/>	0.0.0.0	0.0.0.0	<input type="checkbox"/>	<input type="checkbox"/>	<input type="checkbox"/>	<input type="checkbox"/>	<input type="checkbox"/>	<input type="checkbox"/>	<input type="checkbox"/>
10	<input type="radio"/>	0.0.0.0	0.0.0.0	<input type="checkbox"/>	<input type="checkbox"/>	<input type="checkbox"/>	<input type="checkbox"/>	<input type="checkbox"/>	<input type="checkbox"/>	<input type="checkbox"/>
11	<input type="radio"/>	0.0.0.0	0.0.0.0	<input type="checkbox"/>	<input type="checkbox"/>	<input type="checkbox"/>	<input type="checkbox"/>	<input type="checkbox"/>	<input type="checkbox"/>	<input type="checkbox"/>
12	<input type="radio"/>	0.0.0.0	0.0.0.0	<input type="checkbox"/>	<input type="checkbox"/>	<input type="checkbox"/>	<input type="checkbox"/>	<input type="checkbox"/>	<input type="checkbox"/>	<input type="checkbox"/>
13	<input type="radio"/>	0.0.0.0	0.0.0.0	<input type="checkbox"/>	<input type="checkbox"/>	<input type="checkbox"/>	<input type="checkbox"/>	<input type="checkbox"/>	<input type="checkbox"/>	<input type="checkbox"/>
14	<input type="radio"/>	0.0.0.0	0.0.0.0	<input type="checkbox"/>	<input type="checkbox"/>	<input type="checkbox"/>	<input type="checkbox"/>	<input type="checkbox"/>	<input type="checkbox"/>	<input type="checkbox"/>
15	<input type="radio"/>	0.0.0.0	0.0.0.0	<input type="checkbox"/>	<input type="checkbox"/>	<input type="checkbox"/>	<input type="checkbox"/>	<input type="checkbox"/>	<input type="checkbox"/>	<input type="checkbox"/>
16	<input type="radio"/>	0.0.0.0	0.0.0.0	<input type="checkbox"/>	<input type="checkbox"/>	<input type="checkbox"/>	<input type="checkbox"/>	<input type="checkbox"/>	<input type="checkbox"/>	<input type="checkbox"/>

The following table describes the labels in this screen.

Table 221 SECURITY > Access Control > Remote Management IPv4

LABEL	DESCRIPTION
Entry	This is the client set index number. A “client set” is a group of one or more “trusted computers” from which an administrator may use a service to manage the Switch.
Active	Enable the switch button to activate this secured client set. Clear the checkbox if you wish to temporarily disable the set without deleting it.
Start Address	Configure the IPv4 address range of trusted computers from which you can manage this Switch.
End Address	The Switch checks if the client IPv4 address of a computer requesting a service or protocol matches the range set here. The Switch immediately disconnects the session if it does not match.
Telnet / FTP / HTTP / ICMP / SNMP / SSH / HTTPS	Select services that may be used for managing the Switch from the specified trusted computers.
Apply	Click Apply to save your changes to the Switch’s run-time memory. The Switch loses these changes if it is turned off or loses power, so use the Save link on the top navigation panel to save your changes to the non-volatile memory when you are done configuring.
Cancel	Click Cancel to begin configuring this screen afresh.

66.4 Remote Management (IPv6)

Use this screen to specify a group of one or more “trusted computers using IPv6 addresses” from which an administrator may use a service to manage the Switch.

Click **SECURITY > Access Control > Remote Management IPv6** to view the screen as shown next.

Figure 297 SECURITY > Access Control > Remote Management IPv6

Entry	Active	Start Address	End Address	Telnet	FTP	HTTP	ICMP	SNMP	SSH	HTTPS
1	<input checked="" type="radio"/>	::	::	<input checked="" type="checkbox"/>	<input checked="" type="checkbox"/>	<input checked="" type="checkbox"/>	<input checked="" type="checkbox"/>	<input checked="" type="checkbox"/>	<input checked="" type="checkbox"/>	<input checked="" type="checkbox"/>
2	<input type="radio"/>	::	::	<input type="checkbox"/>	<input type="checkbox"/>	<input type="checkbox"/>	<input type="checkbox"/>	<input type="checkbox"/>	<input type="checkbox"/>	<input type="checkbox"/>
3	<input type="radio"/>	::	::	<input type="checkbox"/>	<input type="checkbox"/>	<input type="checkbox"/>	<input type="checkbox"/>	<input type="checkbox"/>	<input type="checkbox"/>	<input type="checkbox"/>
4	<input type="radio"/>	::	::	<input type="checkbox"/>	<input type="checkbox"/>	<input type="checkbox"/>	<input type="checkbox"/>	<input type="checkbox"/>	<input type="checkbox"/>	<input type="checkbox"/>
5	<input type="radio"/>	::	::	<input type="checkbox"/>	<input type="checkbox"/>	<input type="checkbox"/>	<input type="checkbox"/>	<input type="checkbox"/>	<input type="checkbox"/>	<input type="checkbox"/>
6	<input type="radio"/>	::	::	<input type="checkbox"/>	<input type="checkbox"/>	<input type="checkbox"/>	<input type="checkbox"/>	<input type="checkbox"/>	<input type="checkbox"/>	<input type="checkbox"/>
7	<input type="radio"/>	::	::	<input type="checkbox"/>	<input type="checkbox"/>	<input type="checkbox"/>	<input type="checkbox"/>	<input type="checkbox"/>	<input type="checkbox"/>	<input type="checkbox"/>
8	<input type="radio"/>	::	::	<input type="checkbox"/>	<input type="checkbox"/>	<input type="checkbox"/>	<input type="checkbox"/>	<input type="checkbox"/>	<input type="checkbox"/>	<input type="checkbox"/>
9	<input type="radio"/>	::	::	<input type="checkbox"/>	<input type="checkbox"/>	<input type="checkbox"/>	<input type="checkbox"/>	<input type="checkbox"/>	<input type="checkbox"/>	<input type="checkbox"/>
10	<input type="radio"/>	::	::	<input type="checkbox"/>	<input type="checkbox"/>	<input type="checkbox"/>	<input type="checkbox"/>	<input type="checkbox"/>	<input type="checkbox"/>	<input type="checkbox"/>
11	<input type="radio"/>	::	::	<input type="checkbox"/>	<input type="checkbox"/>	<input type="checkbox"/>	<input type="checkbox"/>	<input type="checkbox"/>	<input type="checkbox"/>	<input type="checkbox"/>
12	<input type="radio"/>	::	::	<input type="checkbox"/>	<input type="checkbox"/>	<input type="checkbox"/>	<input type="checkbox"/>	<input type="checkbox"/>	<input type="checkbox"/>	<input type="checkbox"/>
13	<input type="radio"/>	::	::	<input type="checkbox"/>	<input type="checkbox"/>	<input type="checkbox"/>	<input type="checkbox"/>	<input type="checkbox"/>	<input type="checkbox"/>	<input type="checkbox"/>
14	<input type="radio"/>	::	::	<input type="checkbox"/>	<input type="checkbox"/>	<input type="checkbox"/>	<input type="checkbox"/>	<input type="checkbox"/>	<input type="checkbox"/>	<input type="checkbox"/>
15	<input type="radio"/>	::	::	<input type="checkbox"/>	<input type="checkbox"/>	<input type="checkbox"/>	<input type="checkbox"/>	<input type="checkbox"/>	<input type="checkbox"/>	<input type="checkbox"/>
16	<input type="radio"/>	::	::	<input type="checkbox"/>	<input type="checkbox"/>	<input type="checkbox"/>	<input type="checkbox"/>	<input type="checkbox"/>	<input type="checkbox"/>	<input type="checkbox"/>

The following table describes the labels in this screen.

Table 222 SECURITY > Access Control > Remote Management IPv6

LABEL	DESCRIPTION
Entry	This is the client set index number. A “client set” is a group of one or more “trusted computers” from which an administrator may use a service to manage the Switch.
Active	Enable the switch button to activate this secured client set. Clear the checkbox if you wish to temporarily disable the set without deleting it.
Start Address	Configure the IPv6 address range of trusted computers from which you can manage this Switch.
End Address	The Switch checks if the client IPv6 address of a computer requesting a service or protocol matches the range set here. The Switch immediately disconnects the session if it does not match.

Table 222 SECURITY > Access Control > Remote Management IPv6 (continued)

LABEL	DESCRIPTION
Telnet / FTP / HTTP / ICMP / SNMP / SSH / HTTPS	Select services that may be used for managing the Switch from the specified trusted computers.
Apply	Click Apply to save your changes to the Switch's run-time memory. The Switch loses these changes if it is turned off or loses power, so use the Save link on the top navigation panel to save your changes to the non-volatile memory when you are done configuring.
Cancel	Click Cancel to begin configuring this screen afresh.

66.5 Storm Control Overview

This chapter introduces and shows you how to configure the storm control feature.

66.5.1 What You Can Do

Use the **Storm Control** screen ([Section 66.6 on page 413](#)) to limit the number of broadcast, multicast and destination lookup failure (DLF) packets the Switch receives per second on the ports.

66.6 Storm Control Setup

Click **SECURITY > Storm Control** in the navigation panel to display the screen as shown next.

Figure 298 SECURITY > Storm Control

Storm Control

Active OFF

Port	Broadcast (pkt/s)	Multicast (pkt/s)	DLF (pkt/s)
*	<input type="checkbox"/> <input type="text"/>	<input type="checkbox"/> <input type="text"/>	<input type="checkbox"/> <input type="text"/>
1	<input type="checkbox"/> 0	<input type="checkbox"/> 0	<input type="checkbox"/> 0
2	<input type="checkbox"/> 0	<input type="checkbox"/> 0	<input type="checkbox"/> 0
3	<input type="checkbox"/> 0	<input type="checkbox"/> 0	<input type="checkbox"/> 0
4	<input type="checkbox"/> 0	<input type="checkbox"/> 0	<input type="checkbox"/> 0
5	<input type="checkbox"/> 0	<input type="checkbox"/> 0	<input type="checkbox"/> 0
6	<input type="checkbox"/> 0	<input type="checkbox"/> 0	<input type="checkbox"/> 0
7	<input type="checkbox"/> 0	<input type="checkbox"/> 0	<input type="checkbox"/> 0

Apply Cancel

The following table describes the labels in this screen.

Table 223 SECURITY > Storm Control

LABEL	DESCRIPTION
Active	Enable the switch button to enable traffic storm control on the Switch. Disable the switch button to disable this feature.
Port	This field displays the port number.
*	<p>Settings in this row apply to all ports.</p> <p>Use this row only if you want to make some settings the same for all ports. Use this row first to set the common settings and then make adjustments on a port-by-port basis.</p> <p>Note: Changes in this row are copied to all the ports as soon as you make them.</p>
Broadcast (pkt/s)	Select this option and specify how many broadcast packets the port receives per second.
Multicast (pkt/s)	Select this option and specify how many multicast packets the port receives per second.
DLF (pkt/s)	Select this option and specify how many destination lookup failure (DLF) packets the port receives per second.
Apply	Click Apply to save your changes to the Switch's run-time memory. The Switch loses these changes if it is turned off or loses power, so use the Save link on the top navigation panel to save your changes to the non-volatile memory when you are done configuring.
Cancel	Click Cancel to reset the fields.

CHAPTER 67

Maintenance

This section explains how to configure the screens that let you maintain the firmware and configuration files.

67.1 What You Can Do

- Use the **Restore Configuration** screen (Section 67.2 on page 415) to upload a stored device configuration file.
- Use the **Backup Configuration** screen (Section 67.3 on page 416) to save your configuration for later use.
- Use the **Save Configuration** screen (Section 67.4 on page 416) to save the current configuration settings to a specific configuration file on the Switch.
- Use the **Firmware Upgrade** screen (Section 67.5 on page 417) to upload the latest firmware.
- Use the **Reboot System** screen (Section 67.6 on page 418) to restart the Switch without physically turning the power off and load a specific configuration file.
- Use the **Tech-Support** screen (Section 67.7 on page 419) to create reports for customer support if there are problems with the Switch.

67.2 Restore Configuration

You can restore a previously saved device configuration from your computer.

Click **MAINTENANCE** > **Configuration** > **Restore Configuration** to display the screen as shown next. Use this screen to restore a previously saved configuration from your computer.

Figure 299 MAINTENANCE > Configuration > Restore Configuration

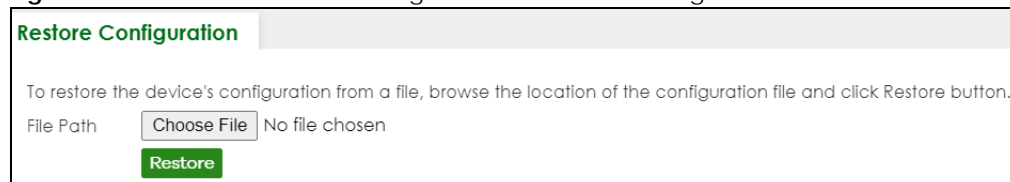

Restore Configuration

To restore the device's configuration from a file, browse the location of the configuration file and click Restore button.

File Path No file chosen

Follow the steps below to restore a previously saved configuration from your computer in this screen.

- 1 Click **Choose File** or **Browse** to locate the configuration file you wish to restore to the Switch.
- 2 Click **Restore**. The restore progress is shown.

Figure 300 Configuration Restoring

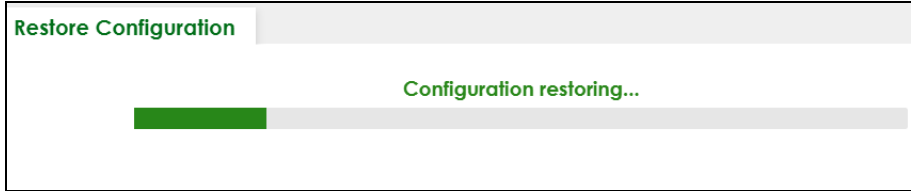

67.3 Backup Configuration

Backing up your Switch configurations allows you to create various “snap shots” of your device from which you may restore at a later date.

Click **MAINTENANCE > Configuration > Backup Configuration** to display the screen as shown next. Use this screen to back up your current Switch configuration and log files to a server or as local files to your computer.

Figure 301 MAINTENANCE > Configuration > Backup Configuration

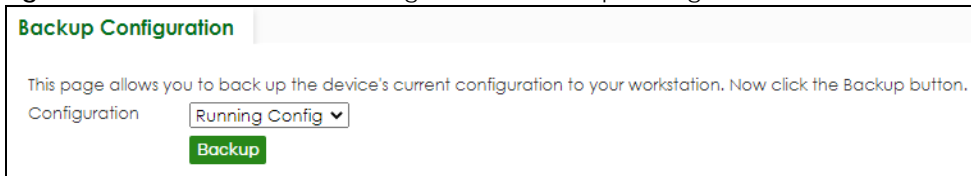

Follow the steps below to back up the current Switch configuration to your computer in this screen.

- 1 Choose the type of configuration files for backup (running, current, and custom default).
- 2 Click **Backup**.
- 3 If a dialog box pops up asking whether you want to open or save the file, click **Save File** to download it to the default downloads folder on your computer. Click **OK** to save the configuration file to your computer.

67.4 Save Configuration

Click **MAINTENANCE > Configuration > Save Configuration** to view the screen as shown next.

Figure 302 MAINTENANCE > Configuration > Save Configuration (Standalone Mode)

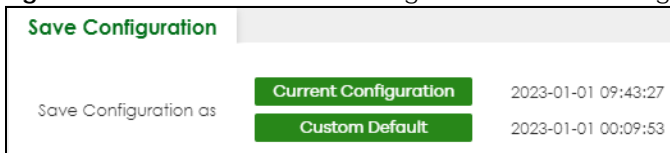
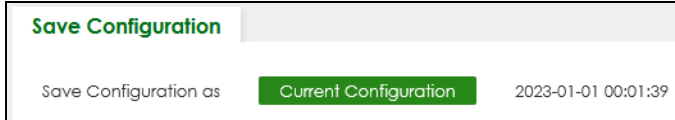

Figure 303 MAINTENANCE > Configuration > Save Configuration (Cloud Mode)

Click **Current Configuration** to save the current configuration settings permanently to the Switch. This configuration is set up according to your network environment.

Click **Custom Default** to save the current configuration settings permanently to a customized default file on the Switch.

Note: **Custom Default** is only available in Standalone mode.

Note: If a customized default file was not saved, clicking **Custom Default** in the **MAINTENANCE > Reboot System** screen loads the factory default configuration on the Switch.

Alternatively, click **Save** on the top right-hand corner in any screen to save the configuration changes to the current configuration.

67.5 Firmware Upgrade

Use the following screen to upgrade your Switch to the latest firmware.

Make sure you have downloaded (and unzipped) the correct model firmware and version to your computer before uploading to the device.

Be sure to upload the correct model firmware as uploading the wrong model firmware may damage your device.

Click **MAINTENANCE > Firmware Upgrade** to view the screen as shown next.

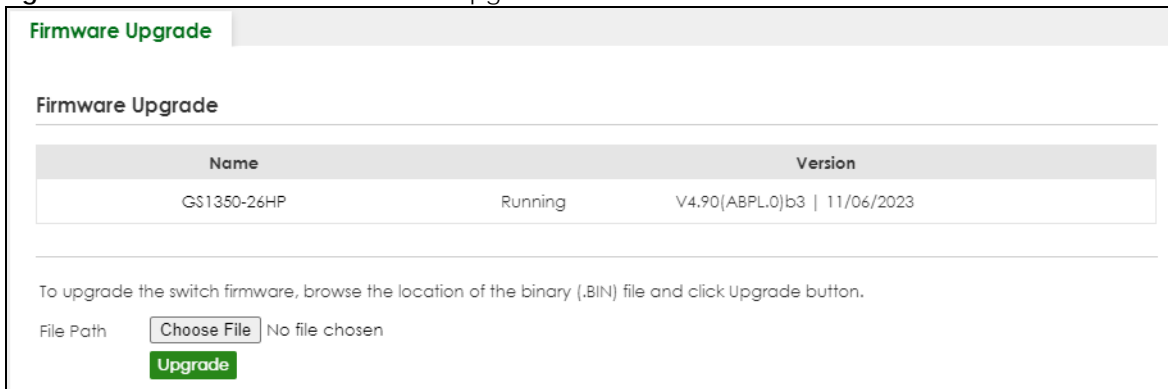
Figure 304 MAINTENANCE > Firmware Upgrade

Click **Choose File** or **Browse** to locate the firmware file you wish to upload to the Switch. Firmware upgrades are only applied after a reboot. Click **Upgrade** to load the new firmware.

After the firmware upgrade process is complete, see the **MONITOR > System Information** screen to verify your current firmware version number.

Table 224 MAINTENANCE > Firmware Upgrade

LABEL	DESCRIPTION
Name	This is the name of the Switch that you are configuring.
Version	This is the version number (and model code) and MM/DD/YYYY creation date of the firmware currently in use on the Switch. The firmware information is also displayed at System Information in Basic Settings.
File Path	Enter the path and file name of the firmware file you wish to upload to the Switch in the Open text box or click Choose File or Browse to locate it.
Upgrade	Click Upgrade to load the new firmware. Firmware upgrades are only applied after a reboot. To reboot, go to MAINTENANCE > Reboot System and click Current Configuration , Factory Default , or Custom Default (Current Configuration , Factory Default , and Custom Default are the configuration files you want the Switch to use when it restarts).

67.6 Reboot System

Reboot System allows you to restart the Switch without physically turning the power off. It also allows you to load the **Current Configuration**, a **Custom Default** or the **Factory Default** configuration when you reboot. Follow the steps below to reboot the Switch.

Note: **Custom Default** is only available in Standalone mode.

Click **MAINTENANCE > Reboot System** to view the screen as shown next.

Figure 305 MAINTENANCE > Reboot System (Standalone Mode)

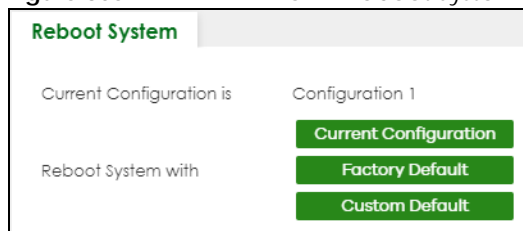
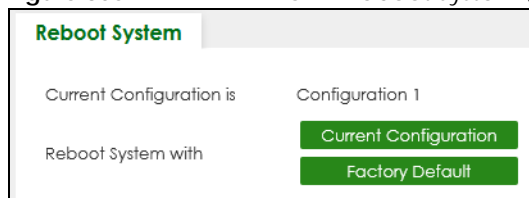
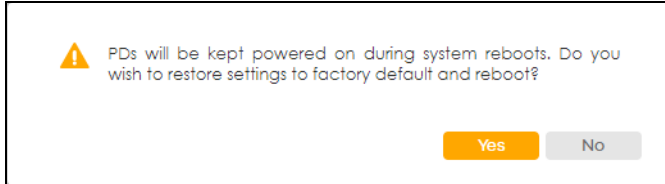

Figure 306 MAINTENANCE > Reboot System (Cloud Mode)



- 1 In the **Reboot System** screen, click a configuration button next to **Reboot System with** to reboot and load that configuration file. The following screen displays.

Figure 307 Reboot Confirmation

- 2 Click **Yes** and then wait for the Switch to restart. This takes up to 2 minutes. This does not affect the Switch's configuration.

Click **Current Configuration** and follow steps 1 to 2 to reboot and load the current configuration on the Switch.

Click **Factory Default** and follow steps 1 to 2 to reboot and load Zyxel factory default configuration settings on the Switch.

Click **Custom Default** and follow steps 1 to 2 to reboot and load a customized default file on the Switch.

67.7 Tech-Support

The Tech-Support feature is a log enhancement tool that logs useful information such as CPU utilization history, memory and Mbuf (Memory Buffer) log and crash reports for issue analysis by customer support should you have difficulty with your Switch. The Tech Support menu eases your effort in obtaining reports and it is also available in CLI command by typing "Show tech-support" command.

Click **MAINTENANCE > Tech-Support** to see the following screen.

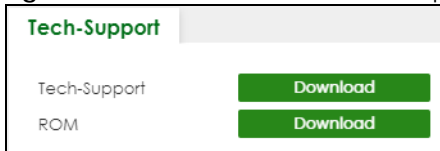
Figure 308 MAINTENANCE > Tech-Support

You may need WordPad or similar software to see the log report correctly. The table below describes the fields in the above screen.

Table 225 MAINTENANCE > Tech-Support

LABEL	DESCRIPTION
Tech-Support	Click Download to see all the log report and system status. This log report is stored in flash memory. If the All log report is too large, you can download the log reports separately below.
ROM	Click Download to see the Read Only Memory (ROM) log report. This report is stored in flash memory.

PART III

Troubleshooting and Appendices

CHAPTER 68

Troubleshooting

This chapter offers some suggestions to solve problems you might encounter. The potential problems are divided into the following categories.

- [Power, Hardware Connections, and LEDs](#)
- [Switch Access and Login](#)
- [Switch Configuration](#)
- [PoE Supply](#)
- [Nebula Registration](#)

68.1 Power, Hardware Connections, and LEDs

[The Switch does not turn on. None of the LEDs turn on.](#)

- 1 Make sure you are using the power adapter or cord included with the Switch.
- 2 Make sure the power adapter or cord is connected to the Switch and plugged in to an appropriate power source. Make sure the power source is turned on.
- 3 Disconnect and re-connect the power adapter or cord to the Switch.
- 4 If the problem continues, contact the vendor.

[One of the LEDs does not behave as expected.](#)

- 1 Make sure you understand the normal behavior of the LED. See [Section 3.3 on page 46](#).
- 2 Check the hardware connections. See [Section 3.1 on page 38](#).
- 3 Inspect your cables for damage. Contact the vendor to replace any damaged cables.
- 4 Disconnect and re-connect the power adapter or cord to the Switch.
- 5 If the problem continues, contact the vendor.

68.2 Switch Access and Login

I can see the **Login** screen, but I cannot log in to the Switch. (I forgot the user name and/or password.)

- 1 Check the Switch's management mode by using the **CLOUD** LED. See [Section 3.3 on page 46](#) for more information on the LED descriptions.
 - If you are in Cloud management mode, use the **Local credentials Password** to log in to the cloud mode – local GUI. The **Local credentials Password** can be found in **Site-wide > Configure > Site settings > Device configuration: Local credentials: Password** in the NCC portal.
 - If you are in standalone management mode, use the default user name **admin** and the default password **1234**.

- 2 Depending on your Switch's management mode, make sure you have entered the correct user name and password. These fields are case-sensitive, please make sure [Caps Lock] is not on.

Note: Steps 1 and 2 are applicable if you get an invalid administrator password when using some functions in the ZON utility. See [Section 1.1.3 on page 26](#) for more information.

- 3 You may have exceeded the maximum number of concurrent Telnet sessions. Close other Telnet sessions or try connecting again later.

Check that you have enabled logins for HTTP or Telnet. If you have configured a secured client IP address, your computer's IP address must match it. Refer to the chapter on access control for details.

- 4 If this does not work, or you are not sure what the Switch's management mode is, you have to reset the device to its factory defaults (Standalone management mode) first. See [Section 4.8 on page 79](#) for more information on resetting the Switch. (Temporarily disconnect the Internet connection to the Switch after the reset process, to prevent the Switch from being managed by NCC again.)

Note: After performing step 4 and you want to use the Cloud management mode, make sure the Switch is registered in your organization and site in the NCC portal. To register the Switch again, scan the QR code using the Zyxel Nebula Mobile app. See the [Section on page 24](#) for more information on using the app to register the Switch.

I forgot the IP address for the Switch.

- 1 You can use the default IP address **https://DHCP-assigned IP** (when connecting to a DHCP server) or **192.168.1.1**. When in Cloud mode, the DHCP-assigned IP address could be found in the NCC portal, in **Site-wide > Devices > Switches** (The Switch must be registered and added to a site in Nebula in order for it to be managed by Nebula).

Note: When your computer is directly connected to the Switch, you can always use the domain name **setup.zyxel** to access the Web Configurator. This requires your computer to be able to connect to a DNS server.

- 2 If the Switch is removed from a site in Nebula, all the settings in the configuration file are reset to the Nebula factory defaults except for the IP address. If you changed the default dynamic IP address to a static IP address while the Switch was in a site in Nebula, the Switch will retain that static IP address after you remove it from the site in Nebula.
- 3 Use the ZON utility to find the IP address.
- 4 If you are using the console/USB port, use the command line **show ip** to find the IP address.
- 5 If this does not work, you have to reset the device to its factory defaults. See [Section 4.8 on page 79](#).

I cannot see or access the **Login** screen in the Web Configurator.

- 1 Make sure you are using the correct IP address.
 - The default IP address is <https://DHCP-assigned IP> (when connecting to a DHCP server) or 192.168.1.1.
 - If you changed the IP address, use the new IP address.
 - If you changed the IP address and have forgotten it, see the troubleshooting suggestions for [I forgot the IP address for the Switch](#).
- 2 Check the hardware connections, and make sure the LEDs are behaving as expected. See [Section 3.3 on page 46](#).
- 3 Make sure your Internet browser does not block pop-up windows and has JavaScripts and Java enabled.
- 4 Make sure your computer is in the same subnet as the Switch. (If you know that there are routers between your computer and the Switch, skip this step.)
- 5 Reset the Switch to its factory defaults, and try to access the Switch with the default IP address. See [Section 4.7 on page 79](#).
- 6 If the problem continues, contact Zyxel technical support, or try the advanced suggestion.

Advanced Suggestion

- Try to access the Switch using another service, such as Telnet. If you can access the Switch, check the remote management settings to find out why the Switch does not respond to HTTP.

Pop-up Windows, JavaScripts and Java Permissions

In order to use the Web Configurator you need to allow:

- Web browser pop-up windows from your device.
- JavaScripts (enabled by default).
- Java permissions (enabled by default).

There is unauthorized access to my Switch through telnet, HTTP and SSH.

Go to the **MONITOR > System Log** screen to check for logs of unauthorized access to your Switch. To avoid unauthorized access, configure the secured client setting in the **SECURITY > Access Control > Remote Management** screen for telnet, HTTP and SSH (see [Section 54.4 on page 307](#)). Computers not belonging to the secured client set cannot get permission to access the Switch.

The Switch is already registered with NCC, but it is still in Standalone mode; it cannot connect to the NCC.

- 1 Make sure that NCC Discovery is enabled. Check the three NCC connection status circles on the **DASHBOARD** screen. All status circles display green (normal) when the Switch is connected and managed by NCC. If a circle displays orange (fails), hover a mouse over the circle to see diagnostic messages for troubleshooting. You can also go to the **SYSTEM > Cloud Management** screen to check the diagnostic messages.
- 2 Check your network's firewall or security settings. Make sure the following TCP ports are allowed: 443, 4335, and 6667.
- 3 Make sure your Switch can access the Internet.
- 4 Make sure your Switch does not have to go through network authentication such as a captive portal. If your network uses a captive portal, the network administrator may have to create a new VLAN without this requirement. Change your Switch's management VLAN settings as necessary.

68.3 Switch Configuration

I lost my configuration settings after I restarted the Switch.

Make sure you save your configuration into the Switch's non-volatile memory each time you make changes. Click **Save** at the top right of the Web Configurator to save the configuration permanently. See also [Section 59.11 on page 350](#) for more information about how to save your configuration.



I accidentally unplugged the Switch. I am not sure which configuration file will be loaded.

If you plug the power cable back to the Switch, it will reboot and load the configuration file that was used the last time. For example, if **Config 1** was used on the Switch before you accidentally unplugged the Switch, **Config 1** will be loaded when rebooting.

I want to use a different configuration file on the Switch, what should I do?

- 1 Go to **MAINTENANCE > Configuration > Restore Configuration**.
- 2 Click **Choose File** or **Browse** to locate the configuration file you wish to restore.
- 3 After you have specified the file, click **Restore**. The Switch will run on the restored configuration after the restore process.

I cannot access the NCC portal.

- Check that you are using the correct URL:
 - NCC: <https://nebula.zyxel.com/>
- Make sure your computer's Ethernet card is installed and functioning properly.
- Check that you have Internet access. In your computer, click **Start, (All) Programs, Accessories** and then **Command Prompt**. In the **Command Prompt** window, enter 'ping' followed by a website such as 'zyxel.com'. If you get a reply, try to ping 'nebula.zyxel.com'.
- Make sure you are using the correct web browser that supports HTML5. View the browser in full screen mode to display the NCC portal properly. Browsers supported are:
 - Google Chrome
 - Microsoft Edge
 - Mozilla Firefox

I cannot log into the NCC portal.

- Open your web browser and go to <https://nebula.zyxel.com>. If you do not have a Nebula (myZyxel.com) account, click **Create account** and create an account.
- If you already have an account but cannot login, click **Forgot Password** to reset the password.

Some features I set using the NCC do not work as expected.

- 1 Make sure your Switch can access the Internet.
- 2 Make sure the Switch's **Status** displays "**Online**" in **Site-wide > Devices > Switches** on the NCC portal.
- 3 If the Switch is offline when the settings were changed, wait for ten minutes after the Switch goes back online.
- 4 After changing your Switch settings using the NCC, wait 1 – 2 minutes for the changes to take effect.

- 5 Check the Switch **Configuration status** in **Site-wide > Devices > Switches** on the NCC portal. The status should display “**up to date**”.

68.4 PoE Supply

[My Powered Devices \(PDs\) are not receiving power.](#)

- 1 Check the **PoE Usage** on the **Dashboard**. This field displays the amount of power the Switch is currently supplying to the connected PDs and the total power the Switch can provide to the connected PDs. It also shows the percentage of PoE power usage.
When PoE usage reaches 100%, the Switch will shut down PDs one-by-one according to the PD **Priority** which you configured in **PORT > PoE Setup > PoE Setup**.
- 2 Use the correct type of Ethernet cable for the corresponding PoE standard you are using.
- 3 Make sure the **Active** checkbox for the port supplying PoE power to PDs is enabled.
- 4 Check if you have set a pre-defined schedule to control when the Switch enables PoE to provide power on the port in **PORT > PoE Setup > PoE Time Range Setup**.
- 5 If the connected IEEE 802.3at / IEEE 802.3af PD does not fully comply with any PoE standard, select **Legacy** or **Force-802.3at** in **PORT > PoE Setup > PoE Setup > Power-Up**.
- 6 If the problem continues, contact Zyxel technical support.

68.5 Nebula Registration

[I cannot register the Switch in Nebula because the previous owner has registered/locked it.](#)

- To register a pre-owned Switch in Nebula, use the Nebula Mobile app to scan the Nebula QR code on the back label of the Switch.
- To register a pre-owned Switch in Nebula locked by the previous owner, inform the previous owner to remove the Switch from the Nebula organization or contact Zyxel technical support.

[I no longer want to use Nebula to manage the Switch, what should I do?](#)

- Remove the Switch from the Nebula organization first. See [From Nebula-managed to Standalone on page 26](#) for details. The Switch will reboot and restore its factory-default settings.

- Make sure the **CLOUD** LED is off or blinking green. See [LEDs on page 46](#) for more information on LED behavior. This means the Switch is operating in standalone mode. Nebula Control Center Discovery is disabled in **SYSTEM > Cloud Management > Nebula Control Center Discovery** in the Web Configurator.

APPENDIX A

Customer Support

In the event of problems that cannot be solved by using this manual, you should contact your vendor. If you cannot contact your vendor, then contact a Zyxel office for the region in which you bought the device.

For Zyxel Communications offices, see <https://service-provider.zyxel.com/global/en/contact-us> for the latest information.

For Zyxel Networks offices, see <https://www.zyxel.com/index.shtml> for the latest information.

Please have the following information ready when you contact an office.

Required Information

- Product model and serial number.
- Warranty Information.
- Date that you received your device.
- Brief description of the problem and the steps you took to solve it.

Corporate Headquarters (Worldwide)

Taiwan

- Zyxel Communications (Taiwan) Co., Ltd.
- <https://www.zyxel.com>

Asia

China

- Zyxel Communications Corporation–China Office
- <https://www.zyxel.com/cn/sc>

India

- Zyxel Communications Corporation–India Office
- <https://www.zyxel.com/in/en-in>

Kazakhstan

- Zyxel Kazakhstan
- <https://www.zyxel.com/ru/ru>

Korea

- Zyxel Korea Co., Ltd.
- <http://www.zyxel.kr/>

Malaysia

- Zyxel Communications Corp.
- <https://www.zyxel.com/global/en>

Philippines

- Zyxel Communications Corp.
- <https://www.zyxel.com/global/en>

Singapore

- Zyxel Communications Corp.
- <https://www.zyxel.com/global/en>

Taiwan

- Zyxel Communications (Taiwan) Co., Ltd.
- <https://www.zyxel.com/tw/zh>

Thailand

- Zyxel Thailand Co., Ltd.
- <https://www.zyxel.com/th/th>

Vietnam

- Zyxel Communications Corporation–Vietnam Office
- <https://www.zyxel.com/vn/vi>

Europe

Belarus

- Zyxel Communications Corp.
- <https://www.zyxel.com/ru/ru>

Belgium (Netherlands)

- Zyxel Benelux
- <https://www.zyxel.com/nl/nl>
- <https://www.zyxel.com/fr/fr>

Bulgaria

- Zyxel Bulgaria

- <https://www.zyxel.com/bg/bg>

Czech Republic

- Zyxel Communications Czech s.r.o.
- <https://www.zyxel.com/cz/cs>

Denmark

- Zyxel Communications A/S
- <https://www.zyxel.com/dk/da>

Finland

- Zyxel Communications
- <https://www.zyxel.com/fi/fi>

France

- Zyxel France
- <https://www.zyxel.com/fr/fr>

Germany

- Zyxel Deutschland GmbH.
- <https://www.zyxel.com/de/de>

Hungary

- Zyxel Hungary & SEE
- <https://www.zyxel.com/hu/hu>

Italy

- Zyxel Communications Italy S.r.l.
- <https://www.zyxel.com/it/it>

Norway

- Zyxel Communications A/S
- <https://www.zyxel.com/no/no>

Poland

- Zyxel Communications Poland
- <https://www.zyxel.com/pl/pl>

Romania

- Zyxel Romania
- <https://www.zyxel.com/ro/ro>

Russian Federation

- Zyxel Communications Corp.
- <https://www.zyxel.com/ru/ru>

Slovakia

- Zyxel Slovakia
- <https://www.zyxel.com/sk/sk>

Spain

- Zyxel Iberia
- <https://www.zyxel.com/es/es>

Sweden

- Zyxel Communications A/S
- <https://www.zyxel.com/se/sv>

Switzerland

- Studerus AG
- <https://www.zyxel.com/ch/de-ch>
- <https://www.zyxel.com/fr/fr>

Turkey

- Zyxel Turkey A.S.
- <https://www.zyxel.com/tr/tr>

UK

- Zyxel Communications UK Ltd.
- <https://www.zyxel.com/uk/en-gb>

Ukraine

- Zyxel Ukraine
- <https://www.zyxel.com/ua/uk-ua>

South America

Argentina

- Zyxel Communications Corp.
- <https://www.zyxel.com/co/es-co>

Brazil

- Zyxel Communications Brasil Ltda.

- <https://www.zyxel.com/br/pt>

Colombia

- Zyxel Communications Corp.
- <https://www.zyxel.com/co/es-co>

Ecuador

- Zyxel Communications Corp.
- <https://www.zyxel.com/co/es-co>

South America

- Zyxel Communications Corp.
- <https://www.zyxel.com/co/es-co>

Middle East

Israel

- Zyxel Communications Corp.
- <https://il.zyxel.com>

North America

USA

- Zyxel Communications, Inc. – North America Headquarters
- <https://www.zyxel.com/us/en-us>

APPENDIX B

Common Services

The following table lists some commonly-used services and their associated protocols and port numbers. For a comprehensive list of port numbers, ICMP type or code numbers and services, visit the IANA (Internet Assigned Number Authority) web site.

- **Name:** This is a short, descriptive name for the service. You can use this one or create a different one, if you like.
- **Protocol:** This is the type of IP protocol used by the service. If this is **TCP/UDP**, then the service uses the same port number with TCP and UDP. If this is **User-Defined**, the **Port(s)** is the IP protocol number, not the port number.
- **Port(s):** This value depends on the **Protocol**. Please refer to RFC 1700 for further information about port numbers.
 - If the **Protocol** is **TCP, UDP, or TCP/UDP**, this is the IP port number.
 - If the **Protocol** is **USER**, this is the IP protocol number.
- **Description:** This is a brief explanation of the applications that use this service or the situations in which this service is used.

Table 226 Commonly Used Services

NAME	PROTOCOL	PORT(S)	DESCRIPTION
AH (IPSEC_TUNNEL)	User-Defined	51	The IPSEC AH (Authentication Header) tunneling protocol uses this service.
AIM/New-ICQ	TCP	5190	AOL's Internet Messenger service. It is also used as a listening port by ICQ.
AUTH	TCP	113	Authentication protocol used by some servers.
BGP	TCP	179	Border Gateway Protocol.
BOOTP_CLIENT	UDP	68	DHCP Client.
BOOTP_SERVER	UDP	67	DHCP Server.
CU-SEEME	TCP UDP	7648 24032	A popular videoconferencing solution from White Pines Software.
DNS	TCP/UDP	53	Domain Name Server, a service that matches web names (for example www.zyxel.com) to IP numbers.
ESP (IPSEC_TUNNEL)	User-Defined	50	The IPSEC ESP (Encapsulation Security Protocol) tunneling protocol uses this service.
FINGER	TCP	79	Finger is a UNIX or Internet related command that can be used to find out if a user is logged on.
FTP	TCP TCP	20 21	File Transfer Program, a program to enable fast transfer of files, including large files that may not be possible by email.
H.323	TCP	1720	NetMeeting uses this protocol.
HTTP	TCP	80	Hyper Text Transfer Protocol – a client or server protocol for the world wide web.

Table 226 Commonly Used Services (continued)

NAME	PROTOCOL	PORT(S)	DESCRIPTION
HTTPS	TCP	443	HTTPS is a secured http session often used in e-commerce.
ICMP	User-Defined	1	Internet Control Message Protocol is often used for diagnostic or routing purposes.
ICQ	UDP	4000	This is a popular Internet chat program.
IGMP (MULTICAST)	User-Defined	2	Internet Group Multicast Protocol is used when sending packets to a specific group of hosts.
IKE	UDP	500	The Internet Key Exchange algorithm is used for key distribution and management.
IRC	TCP/UDP	6667	This is another popular Internet chat program.
MSN Messenger	TCP	1863	Microsoft Networks' messenger service uses this protocol.
NEW-ICQ	TCP	5190	An Internet chat program.
NEWS	TCP	144	A protocol for news groups.
NFS	UDP	2049	Network File System – NFS is a client or server distributed file service that provides transparent file sharing for network environments.
NNTP	TCP	119	Network News Transport Protocol is the delivery mechanism for the USENET newsgroup service.
PING	User-Defined	1	Packet Internet Groper is a protocol that sends out ICMP echo requests to test whether or not a remote host is reachable.
POP3	TCP	110	Post Office Protocol version 3 lets a client computer get e-mail from a POP3 server through a temporary connection (TCP/IP or other).
PPTP	TCP	1723	Point-to-Point Tunneling Protocol enables secure transfer of data over public networks. This is the control channel.
PPTP_TUNNEL (GRE)	User-Defined	47	PPTP (Point-to-Point Tunneling Protocol) enables secure transfer of data over public networks. This is the data channel.
RCMD	TCP	512	Remote Command Service.
REAL_AUDIO	TCP	7070	A streaming audio service that enables real time sound over the web.
REXEC	TCP	514	Remote Execution Daemon.
RLOGIN	TCP	513	Remote Login.
RTELNET	TCP	107	Remote Telnet.
RTSP	TCP/UDP	554	The Real Time Streaming (media control) Protocol (RTSP) is a remote control for multimedia on the Internet.
SFTP	TCP	115	Simple File Transfer Protocol.
SMTP	TCP	25	Simple Mail Transfer Protocol is the message-exchange standard for the Internet. SMTP enables you to move messages from one email server to another.
SNMP	TCP/UDP	161	Simple Network Management Program.
SNMP-TRAPS	TCP/UDP	162	Traps for use with the SNMP (RFC:1215).

Table 226 Commonly Used Services (continued)

NAME	PROTOCOL	PORT(S)	DESCRIPTION
SQL-NET	TCP	1521	Structured Query Language is an interface to access data on many different types of database systems, including mainframes, midrange systems, UNIX systems and network servers.
SSH	TCP/UDP	22	Secure Shell Remote Login Program.
STRM WORKS	UDP	1558	Stream Works Protocol.
SYSLOG	UDP	514	Syslog allows you to send system logs to a UNIX server.
TACACS	UDP	49	Login Host Protocol used for (Terminal Access Controller Access Control System).
TELNET	TCP	23	Telnet is the login and terminal emulation protocol common on the Internet and in UNIX environments. It operates over TCP/IP networks. Its primary function is to allow users to log into remote host systems.
TFTP	UDP	69	Trivial File Transfer Protocol is an Internet file transfer protocol similar to FTP, but uses the UDP (User Datagram Protocol) rather than TCP (Transmission Control Protocol).
VDOLIVE	TCP	7000	Another videoconferencing solution.

APPENDIX C

IPv6

Overview

IPv6 (Internet Protocol version 6), is designed to enhance IP address size and features. The increase in IPv6 address size to 128 bits (from the 32-bit IPv4 address) allows up to 3.4×10^{38} IP addresses.

IPv6 Addressing

The 128-bit IPv6 address is written as eight 16-bit hexadecimal blocks separated by colons (:). This is an example IPv6 address `2001:0db8:1a2b:0015:0000:0000:1a2f:0000`.

IPv6 addresses can be abbreviated in two ways:

- Leading zeros in a block can be omitted. So `2001:0db8:1a2b:0015:0000:0000:1a2f:0000` can be written as `2001:db8:1a2b:15:0:0:1a2f:0`.
- Any number of consecutive blocks of zeros can be replaced by a double colon. A double colon can only appear once in an IPv6 address. So `2001:0db8:0000:0000:1a2f:0000:0000:0015` can be written as `2001:0db8::1a2f:0000:0000:0015`, `2001:0db8:0000:0000:1a2f::0015`, `2001:db8::1a2f:0:0:15` or `2001:db8:0:0:1a2f::15`.

Prefix and Prefix Length

Similar to an IPv4 subnet mask, IPv6 uses an address prefix to represent the network address. An IPv6 prefix length specifies how many most significant bits (start from the left) in the address compose the network address. The prefix length is written as “/x” where x is a number. For example,

`2001:db8:1a2b:15::1a2f:0/32`

means that the first 32 bits (`2001:db8`) is the subnet prefix.

Link-local Address

A link-local address uniquely identifies a device on the local network (the LAN). It is similar to a “private IP address” in IPv4. You can have the same link-local address on multiple interfaces on a device. A link-local unicast address has a predefined prefix of `fe80::/10`. The link-local unicast address format is as follows.

Table 227 Link-local Unicast Address Format

1111 1110 10	0	Interface ID
10 bits	54 bits	64 bits

Global Address

A global address uniquely identifies a device on the Internet. It is similar to a “public IP address” in IPv4. A global unicast address starts with a 2 or 3.

Unspecified Address

An unspecified address (0:0:0:0:0:0 or ::) is used as the source address when a device does not have its own address. It is similar to "0.0.0.0" in IPv4.

Loopback Address

A loopback address (0:0:0:0:0:1 or ::1) allows a host to send packets to itself. It is similar to "127.0.0.1" in IPv4.

Multicast Address

In IPv6, multicast addresses provide the same functionality as IPv4 broadcast addresses. Broadcasting is not supported in IPv6. A multicast address allows a host to send packets to all hosts in a multicast group.

Multicast scope allows you to determine the size of the multicast group. A multicast address has a predefined prefix of ff00::/8. The following table describes some of the predefined multicast addresses.

Table 228 Predefined Multicast Address

MULTICAST ADDRESS	DESCRIPTION
FF01:0:0:0:0:0:0:1	All hosts on a local node.
FF01:0:0:0:0:0:0:2	All routers on a local node.
FF02:0:0:0:0:0:0:1	All hosts on a local connected link.
FF02:0:0:0:0:0:0:2	All routers on a local connected link.
FF05:0:0:0:0:0:0:2	All routers on a local site.
FF05:0:0:0:0:0:1:3	All DHCP servers on a local site.

The following table describes the multicast addresses which are reserved and cannot be assigned to a multicast group.

Table 229 Reserved Multicast Address

MULTICAST ADDRESS
FF00:0:0:0:0:0:0:0
FF01:0:0:0:0:0:0:0
FF02:0:0:0:0:0:0:0
FF03:0:0:0:0:0:0:0
FF04:0:0:0:0:0:0:0
FF05:0:0:0:0:0:0:0
FF06:0:0:0:0:0:0:0
FF07:0:0:0:0:0:0:0
FF08:0:0:0:0:0:0:0
FF09:0:0:0:0:0:0:0
FF0A:0:0:0:0:0:0:0
FF0B:0:0:0:0:0:0:0
FF0C:0:0:0:0:0:0:0
FF0D:0:0:0:0:0:0:0
FF0E:0:0:0:0:0:0:0
FF0F:0:0:0:0:0:0:0

Subnet Masking

Both an IPv6 address and IPv6 subnet mask compose of 128-bit binary digits, which are divided into eight 16-bit blocks and written in hexadecimal notation. Hexadecimal uses 4 bits for each character (1 – 10, A – F). Each block's 16 bits are then represented by 4 hexadecimal characters. For example, FFFF:FFFF:FFFF:FFFF:FC00:0000:0000:0000.

Interface ID

In IPv6, an interface ID is a 64-bit identifier. It identifies a physical interface (for example, an Ethernet port) or a virtual interface (for example, the management IP address for a VLAN). One interface should have a unique interface ID.

EUI-64

The EUI-64 (Extended Unique Identifier) defined by the IEEE (Institute of Electrical and Electronics Engineers) is an interface ID format designed to adapt with IPv6. It is derived from the 48-bit (6-byte) Ethernet MAC address as shown next. EUI-64 inserts the hex digits fffe between the third and fourth bytes of the MAC address and complements the seventh bit of the first byte of the MAC address. See the following example.

Table 230

MAC	00	:	13	:	49	:	12	:	34	:	56
------------	----	---	----	---	----	---	----	---	----	---	----

Table 231

EUI-64	02	:	13	:	49	:	FF	:	FE	:	12	:	34	:	56
---------------	----	---	----	---	----	---	----	---	----	---	----	---	----	---	----

DHCPv6

The Dynamic Host Configuration Protocol for IPv6 (DHCPv6, RFC 3315) is a server-client protocol that allows a DHCP server to assign and pass IPv6 network addresses, prefixes and other configuration information to DHCP clients. DHCPv6 servers and clients exchange DHCP messages using UDP.

Each DHCP client and server has a unique DHCP Unique Identifier (DUID), which is used for identification when they are exchanging DHCPv6 messages. The DUID is generated from the MAC address, time, vendor assigned ID and/or the vendor's private enterprise number registered with the IANA. It should not change over time even after you reboot the device.

Identity Association

An Identity Association (IA) is a collection of addresses assigned to a DHCP client, through which the server and client can manage a set of related IP addresses. Each IA must be associated with exactly one interface. The DHCP client uses the IA assigned to an interface to obtain configuration from a DHCP server for that interface. Each IA consists of a unique IAID and associated IP information.

The IA type is the type of address in the IA. Each IA holds one type of address. IA_NA means an identity association for non-temporary addresses and IA_TA is an identity association for temporary addresses.

An IA_NA option contains the T1 and T2 fields, but an IA_TA option does not. The DHCPv6 server uses T1 and T2 to control the time at which the client contacts with the server to extend the lifetimes on any addresses in the IA_NA before the lifetimes expire. After T1, the client sends the server (**S1**) (from which the addresses in the IA_NA were obtained) a Renew message. If the time T2 is reached and the server does not respond, the client sends a Rebind message to any available server (**S2**). For an IA_TA, the

client may send a Renew or Rebind message at the client's discretion.

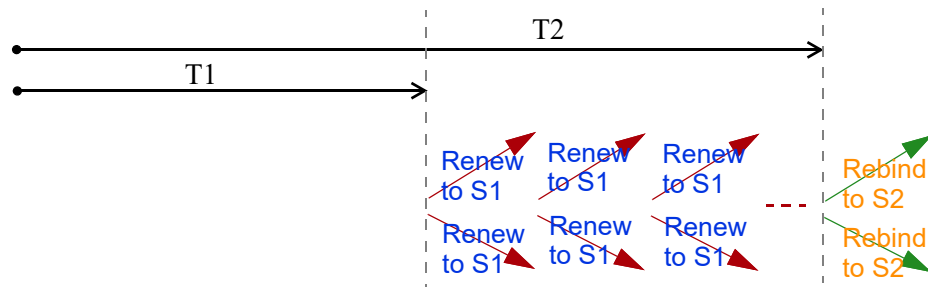

DHCP Relay Agent

A DHCP relay agent is on the same network as the DHCP clients and helps forward messages between the DHCP server and clients. When a client cannot use its link-local address and a well-known multicast address to locate a DHCP server on its network, it then needs a DHCP relay agent to send a message to a DHCP server that is not attached to the same network.

The DHCP relay agent can add the remote identification (remote-ID) option and the interface-ID option to the Relay-Forward DHCPv6 messages. The remote-ID option carries a user-defined string, such as the system name. The interface-ID option provides slot number, port information and the VLAN ID to the DHCPv6 server. The remote-ID option (if any) is stripped from the Relay-Reply messages before the relay agent sends the packets to the clients. The DHCP server copies the interface-ID option from the Relay-Forward message into the Relay-Reply message and sends it to the relay agent. The interface-ID should not change even after the relay agent restarts.

Prefix Delegation

Prefix delegation enables an IPv6 router to use the IPv6 prefix (network address) received from the ISP (or a connected uplink router) for its LAN. The Switch uses the received IPv6 prefix (for example, 2001:db2::/48) to generate its LAN IP address. Through sending Router Advertisements (RAs) regularly by multicast, the Switch passes the IPv6 prefix information to its LAN hosts. The hosts then can use the prefix to generate their IPv6 addresses.

ICMPv6

Internet Control Message Protocol for IPv6 (ICMPv6 or ICMP for IPv6) is defined in RFC 4443. ICMPv6 has a preceding Next Header value of 58, which is different from the value used to identify ICMP for IPv4. ICMPv6 is an integral part of IPv6. IPv6 nodes use ICMPv6 to report errors encountered in packet processing and perform other diagnostic functions, such as "ping".

Neighbor Discovery Protocol (NDP)

The Neighbor Discovery Protocol (NDP) is a protocol used to discover other IPv6 devices and track neighbor's reachability in a network. An IPv6 device uses the following ICMPv6 messages types:

- Neighbor solicitation: A request from a host to determine a neighbor's link-layer address (MAC address) and detect if the neighbor is still reachable. A neighbor being "reachable" means it responds to a neighbor solicitation message (from the host) with a neighbor advertisement message.
- Neighbor advertisement: A response from a node to announce its link-layer address.
- Router solicitation: A request from a host to locate a router that can act as the default router and

forward packets.

- Router advertisement: A response to a router solicitation or a periodical multicast advertisement from a router to advertise its presence and other parameters.

IPv6 Cache

An IPv6 host is required to have a neighbor cache, destination cache, prefix list and default router list. The Switch maintains and updates its IPv6 caches constantly using the information from response messages. In IPv6, the Switch configures a link-local address automatically, and then sends a neighbor solicitation message to check if the address is unique. If there is an address to be resolved or verified, the Switch also sends out a neighbor solicitation message. When the Switch receives a neighbor advertisement in response, it stores the neighbor's link-layer address in the neighbor cache. When the Switch uses a router solicitation message to query for a router and receives a router advertisement message, it adds the router's information to the neighbor cache, prefix list and destination cache. The Switch creates an entry in the default router list cache if the router can be used as a default router.

When the Switch needs to send a packet, it first consults the destination cache to determine the next hop. If there is no matching entry in the destination cache, the Switch uses the prefix list to determine whether the destination address is on-link and can be reached directly without passing through a router. If the address is onlink, the address is considered as the next hop. Otherwise, the Switch determines the next-hop from the default router list or routing table. Once the next hop IP address is known, the Switch looks into the neighbor cache to get the link-layer address and sends the packet when the neighbor is reachable. If the Switch cannot find an entry in the neighbor cache or the state for the neighbor is not reachable, it starts the address resolution process. This helps reduce the number of IPv6 solicitation and advertisement messages.

Multicast Listener Discovery

The Multicast Listener Discovery (MLD) protocol (defined in RFC 2710) is derived from IPv4's Internet Group Management Protocol version 2 (IGMPv2). MLD uses ICMPv6 message types, rather than IGMP message types. MLDv1 is equivalent to IGMPv2 and MLDv2 is equivalent to IGMPv3.

MLD allows an IPv6 switch or router to discover the presence of MLD listeners who wish to receive multicast packets and the IP addresses of multicast groups the hosts want to join on its network.

MLD snooping and MLD proxy are analogous to IGMP snooping and IGMP proxy in IPv4.

MLD filtering controls which multicast groups a port can join.

MLD Messages

A multicast router or switch periodically sends general queries to MLD hosts to update the multicast forwarding table. When an MLD host wants to join a multicast group, it sends an MLD Report message for that address.

An MLD Done message is equivalent to an IGMP Leave message. When an MLD host wants to leave a multicast group, it can send a Done message to the router or switch. The router or switch then sends a group-specific query to the port on which the Done message is received to determine if other devices connected to this port should remain in the group.

Example – Enabling IPv6 on Windows 7

Windows 7 supports IPv6 by default. DHCPv6 is also enabled when you enable IPv6 on a Windows 7 computer.

To enable IPv6 in Windows 7:

- 1 Select **Control Panel > Network and Sharing Center > Local Area Connection**.
- 2 Select the **Internet Protocol Version 6 (TCP/IPv6)** check box to enable it.
- 3 Click **OK** to save the change.

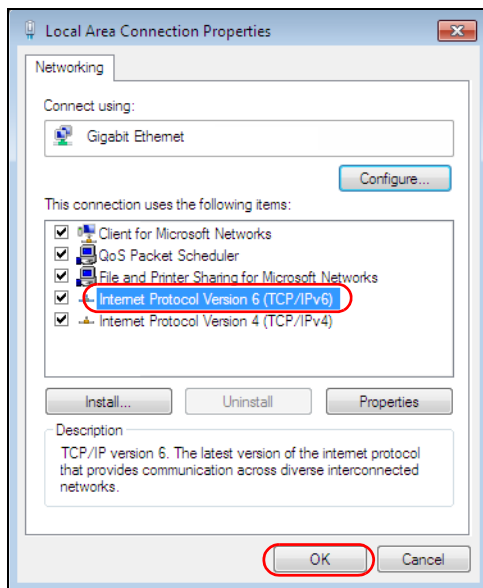

- 4 Click **Close** to exit the **Local Area Connection Status** screen.
- 5 Select **Start > All Programs > Accessories > Command Prompt**.
- 6 Use the `ipconfig` command to check your dynamic IPv6 address. This example shows a global address (2001:b021:2d::1000) obtained from a DHCP server.

```
C:\>ipconfig

Windows IP Configuration

Ethernet adapter Local Area Connection:

    Connection-specific DNS Suffix  . : 
    IPv6 Address. . . . . : 2001:b021:2d::1000
    Link-local IPv6 Address . . . . . : fe80::25d8:dcab:c80a:5189%11
    IPv4 Address. . . . . : 172.16.100.61
    Subnet Mask . . . . . : 255.255.255.0
    Default Gateway . . . . . : fe80::213:49ff:feaa:7125%11
                                172.16.100.254
```

Example – Enabling IPv6 on Windows 10

Windows 10 supports IPv6 by default. DHCPv6 is enabled when you enable IPv6 on a Windows 10 PC.

To enable IPv6 in Windows 10:

- 1 Select **Control Panel > Network and Sharing Center**.
- 2 On the left side of the **Network and Sharing Center**, select **Change adapter settings**.
- 3 Right-click your network connection and select **Properties**.
- 4 Select the **Internet Protocol Version 6 (TCP/IPv6)** check box to enable it.
- 5 Click **OK** to save the changes for the selected network adapter.

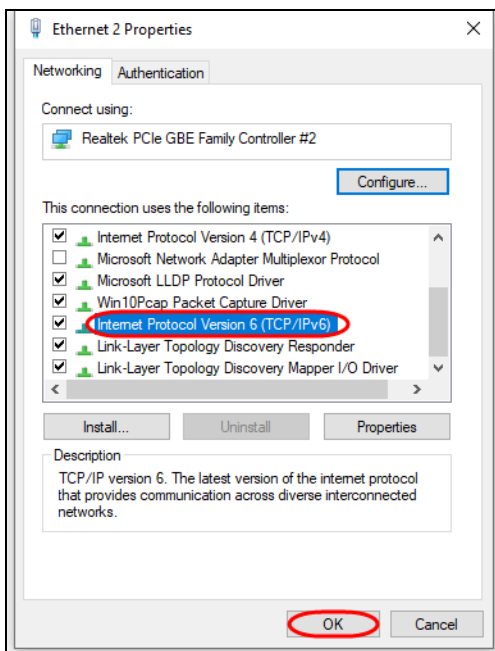

- 6 Click **OK** to exit the selected network adapter **Properties** screen.

Example – Enabling DHCPv6 on Windows 10

Windows 10 supports DHCPv6 by default. To enable DHCPv6 client on your computer:

- 1 Select **Start > Settings > Network & Internet**.
- 2 On the left side of the **Network & Internet**, select **Ethernet**. Then select the Ethernet network you are connected to.
- 3 Under **IP assignment**, select **Edit**.
- 4 Under **Edit IP settings**, select **Automatic (DHCP)** or **Manual**. Then click **Save**.

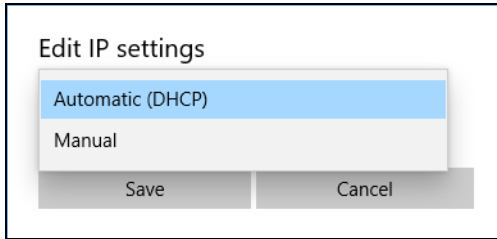

- When you select **Automatic (DHCP)**, the IP address settings and DNS server address setting are set automatically by your router.
- When you select **Manual**, you can manually set your IP address settings and DNS server address.

Now your computer can obtain an IPv6 address from a DHCPv6 server.

APPENDIX D

Importing a Certificate

When you connect to the Switch Web Configurator using HTTPS, a warning screen “Your connection is not private” may show up. If you see this warning screen, it indicates that your web browser has failed to verify the Secure Sockets Layer (SSL) certificate, which opens an encrypted connection. You can ignore this message and proceed to the website.

This appendix shows you how to import a public key certificate into your web browser to avoid the “Your connection is not private” screen. The web browsers are:

- Google Chrome
- Microsoft Edge
- Mozilla Firefox.

Public key certificates are used by web browsers to ensure that a secure web site is legitimate. When a certificate authority such as VeriSign, Comodo, or Network Solutions, to name a few, receives a certificate request from a website operator, they confirm that the web domain and contact information in the request match those on public record with a domain name registrar. If they match, then the certificate is issued to the website operator, who then places it on the website to be issued to all visiting web browsers to let them know that the website is legitimate.

Many Zyxel products, such as the Switch, issue their own public key certificates. These can be used by web browsers on a LAN or WAN to verify that they are in fact connecting to the legitimate device and not one masquerading as it. However, because the certificates were not issued by one of the several organizations officially recognized by the most common web browsers, you will need to import the Zyxel-created certificate into your web browser and flag that certificate as a trusted authority.

Note: You can see if you are browsing on a secure website if the URL on your web browser’s address bar begins with `https://` or there is a sealed padlock icon () somewhere in the web browser window (not all web browsers show the padlock in the same location).

Note: You need a certificate from a trusted Certification Authority (CA) for this Switch.

Importing a Certificate to Google Chrome and Microsoft Edge

The following example uses Google Chrome on Windows 10. You first have to store the certificate in your computer and then install it as a Trusted Root CA, as shown in the following tutorial.

The Importing process is quite similar between Google Chrome and Microsoft Edge. The following procedures in Google Chrome can apply the same way in Microsoft Edge.

- 1 Open the Google Chrome browser. Click the three dots on the upper right. Then choose **Settings**.

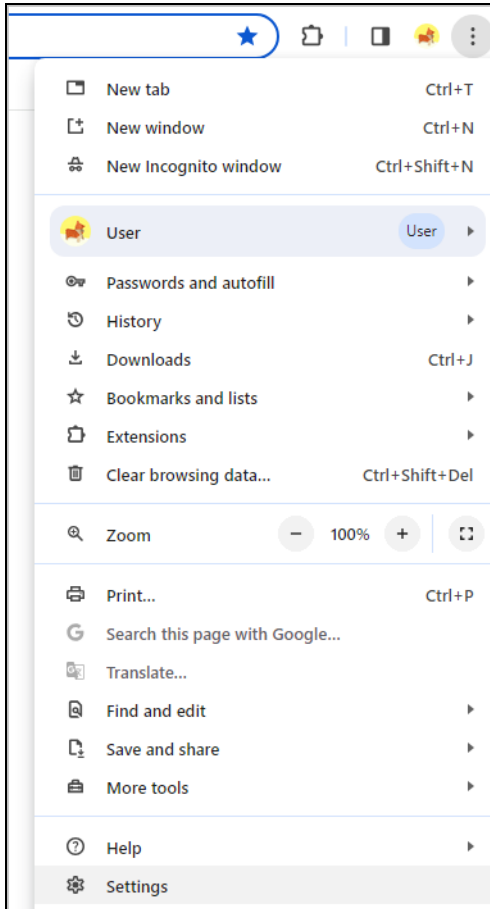

- 2 In Google Chrome, click **Privacy and security** > **Security** > **Manage certificates**.
In Microsoft Edge, click **Privacy, search, and services** > **Manage certificates**.

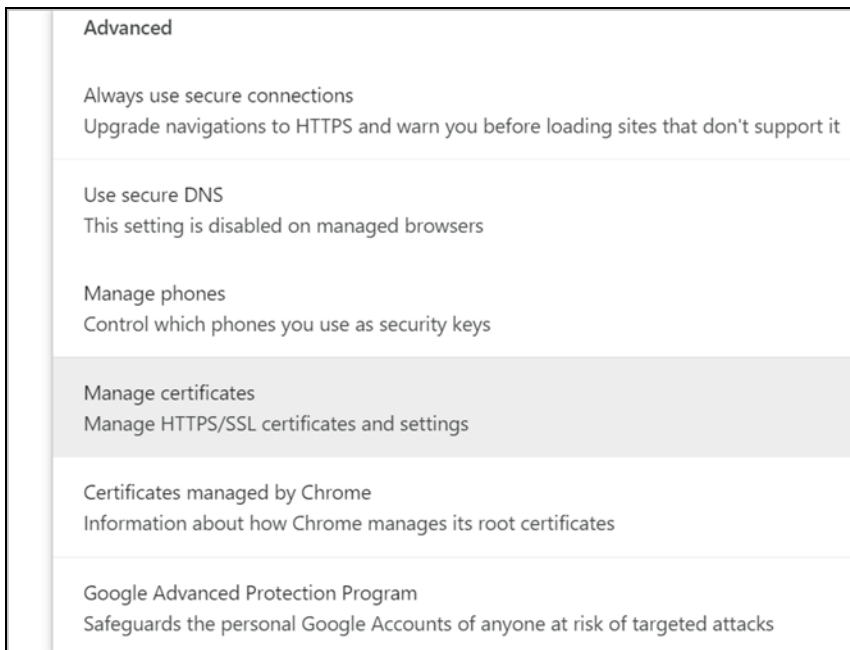

- 3 Select the **Trusted Root Certification Authorities** tab and click **Import**.

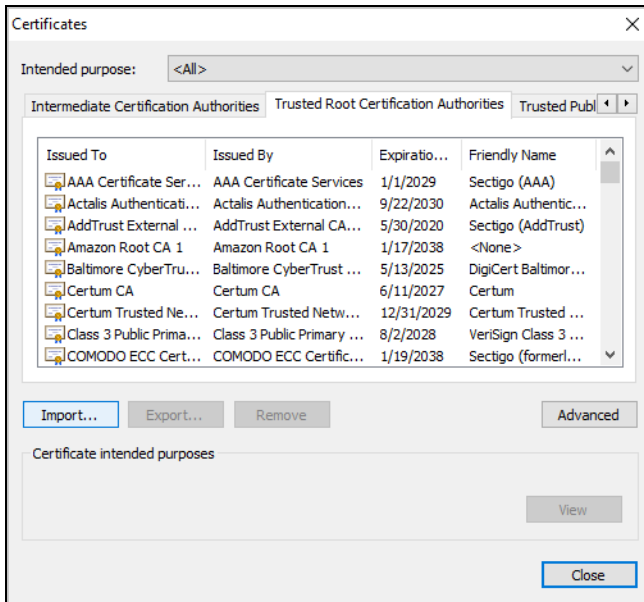

- 4 The **Certificate Import Wizard** screen appears. Click **Next** to continue.

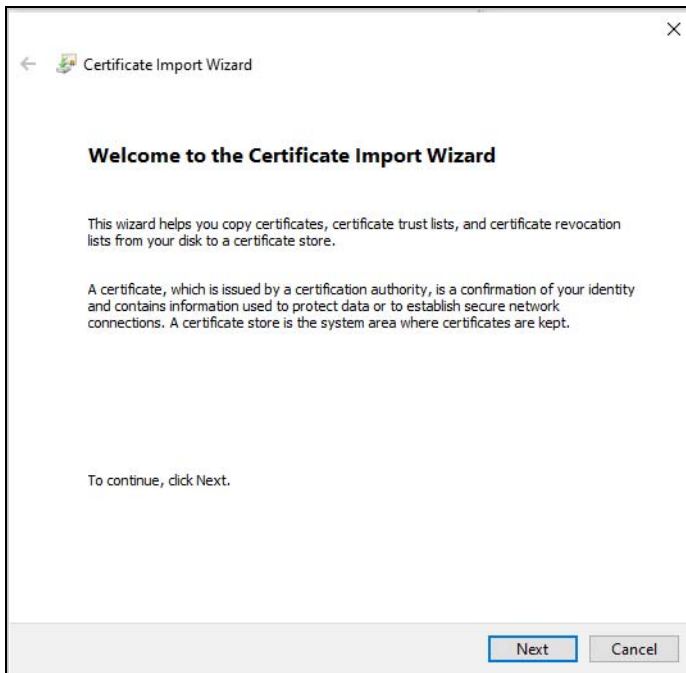

- 5 Click **Browse** to select a certificate already saved in your computer and click **Next** to continue.

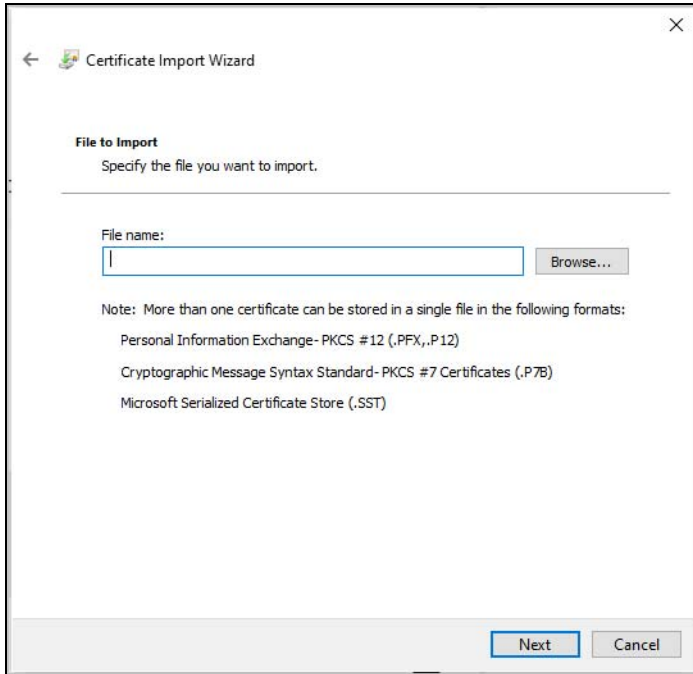

- 6 Select **All Files** to locate the certificate in your computer.

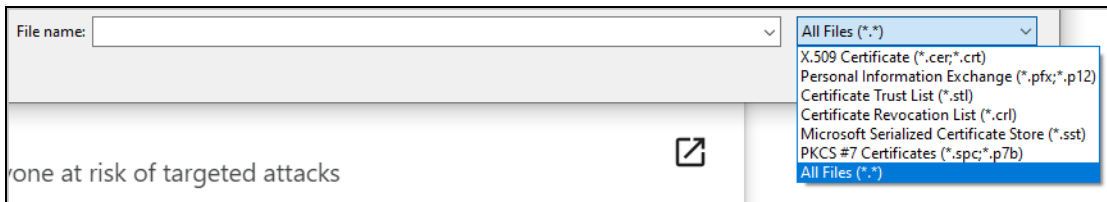

- 7 Two options are available for certificate stores. One is **Automatically select the certificate store based on the type of certificate**. This means the certificate import wizard can identify from the certificate whether it is a CA certificate or a personal certificate, and install it into the appropriate certificate store. The other option is **Place all certificates in the following store**. With this option, you can choose the desired folder for the certificate store. After selection, click **Next**.

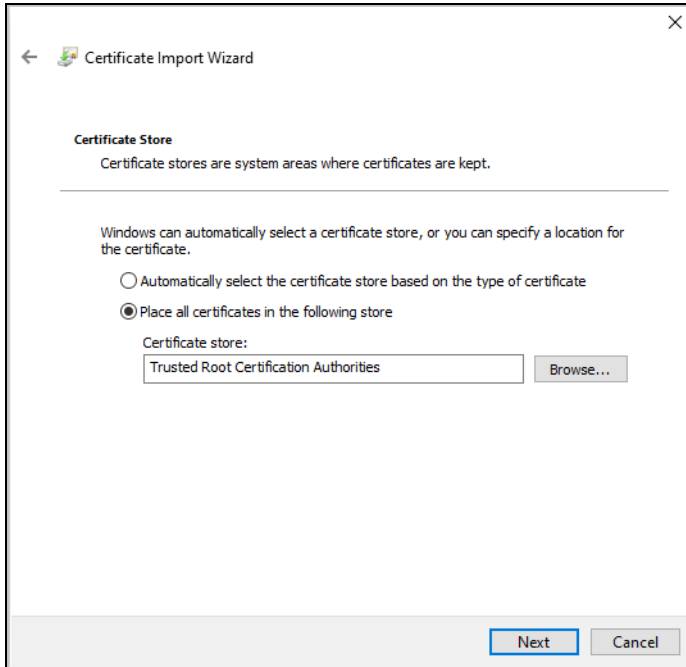

- 8 A security warning message appears, click **Yes** to continue.

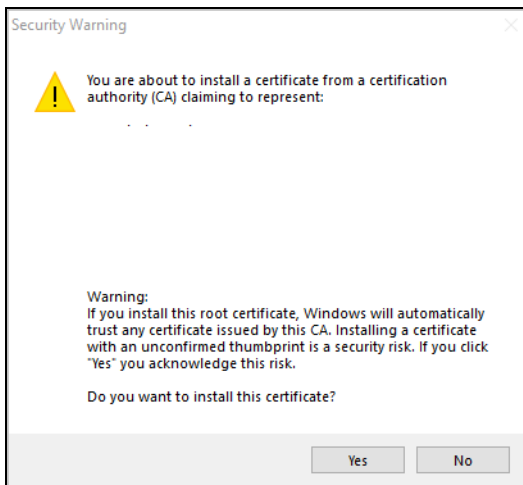

- 9 Click **Finish** to exit the wizard.

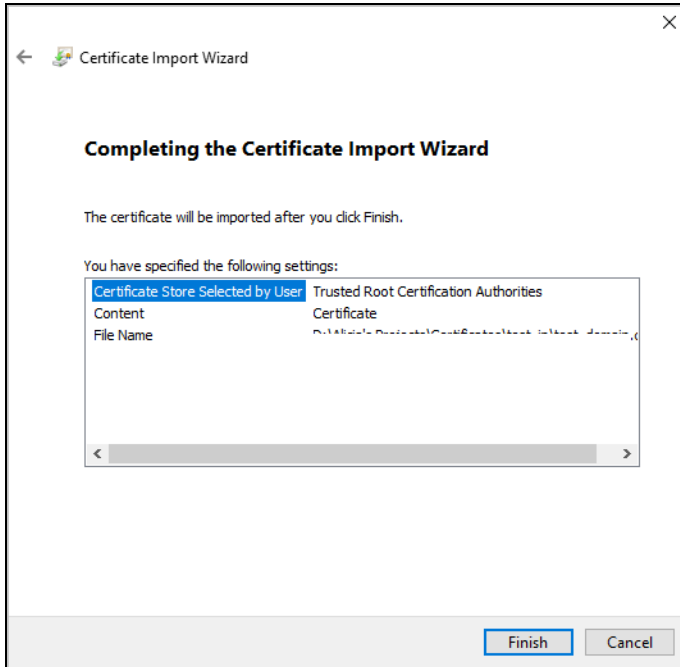

A pop-up screen informs you that the import was successful.

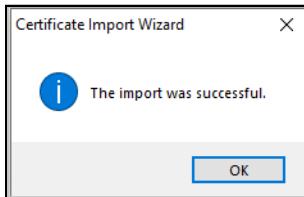

Remove a Certificate in Google Chrome and Microsoft Edge

This section shows you how to remove a public key certificate in Google Chrome and Microsoft Edge on Windows 10.

- 1 Open your web browser, click the three dots on the upper right, and click **Settings**.

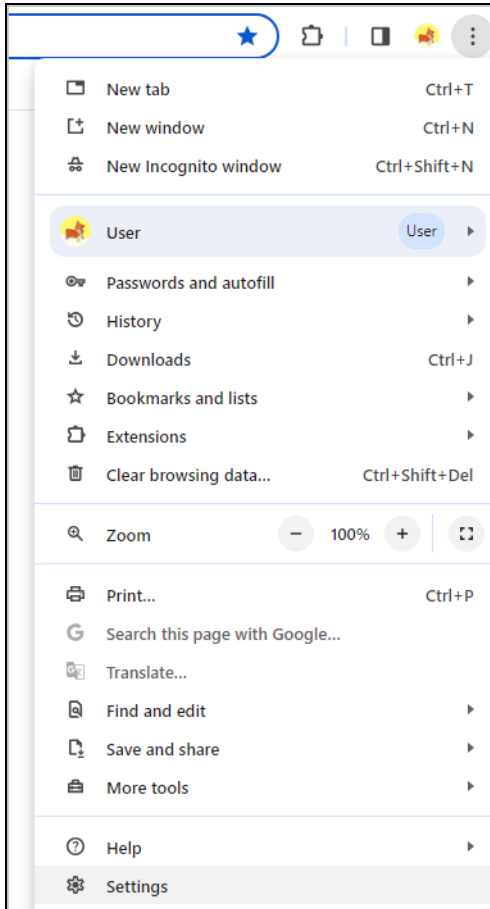

- 2 In Google Chrome, click **Privacy and security** > **Security** > **Manage certificates**.
In Microsoft Edge, click **Privacy, search, and services** > **Manage certificates**.

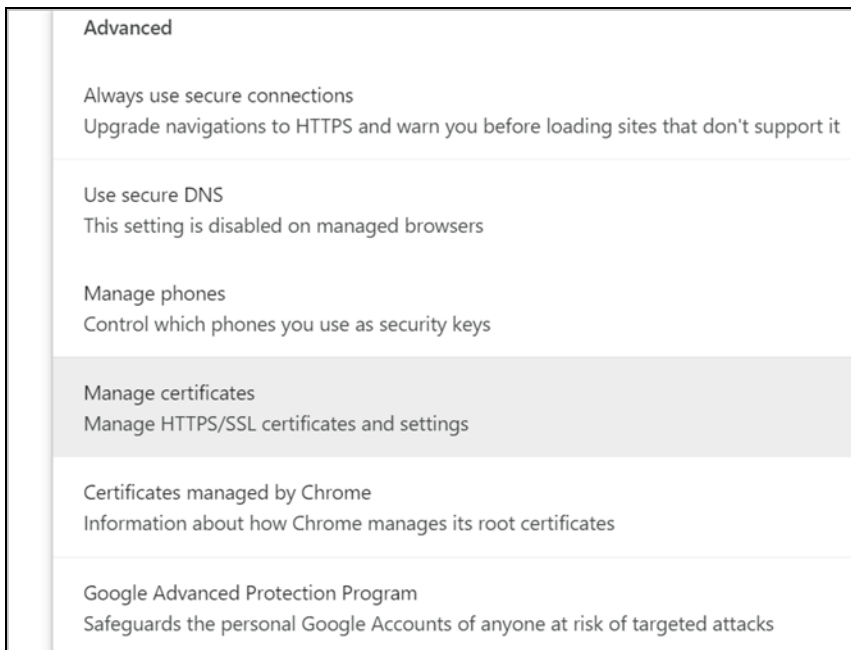

- 3 On the **Certificates** screen, select the **Trusted Root Certification Authorities** tab.

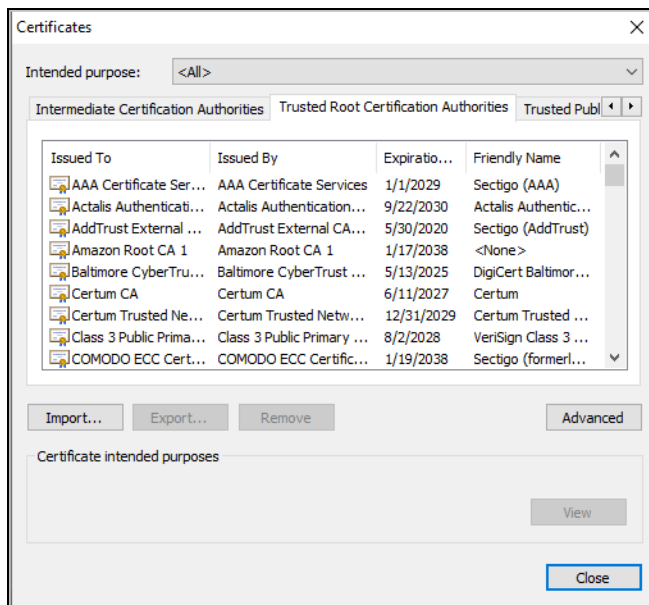

- 4 Select the certificate you want to remove and click **Remove**.
- 5 Click **Yes** when you see the following warning message.

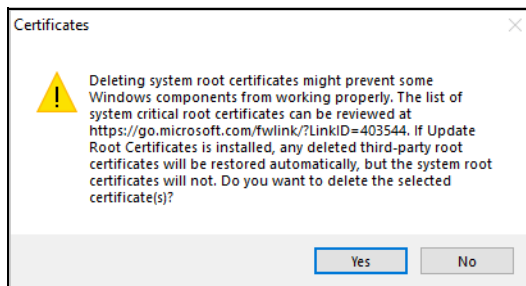

- 6 Confirm the details displayed in the warning message and click **Yes**.

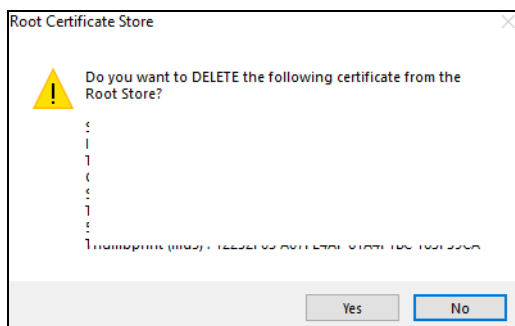

Import a Certificate to Mozilla Firefox

The following example uses Mozilla Firefox on Windows 10. You first have to store the certificate in your computer and then install it as a Trusted Root CA. To import a certificate to the Firefox browser, do the following:

- 1 Open the Firefox browser and click the **Open application menu** icon on the upper right. Then click **Settings**.

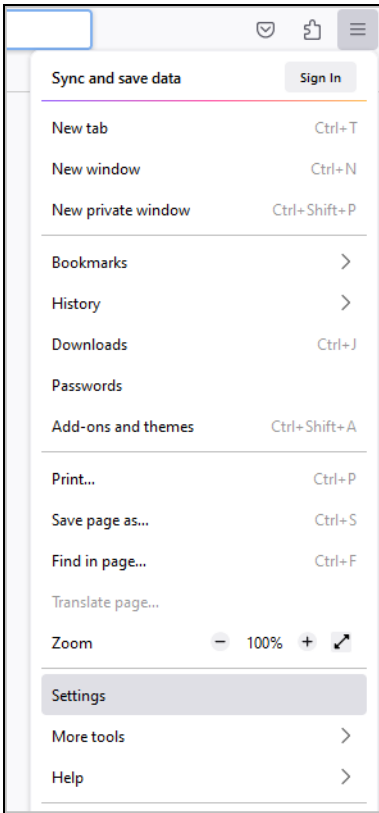

- 2 Click **Privacy & Security**.

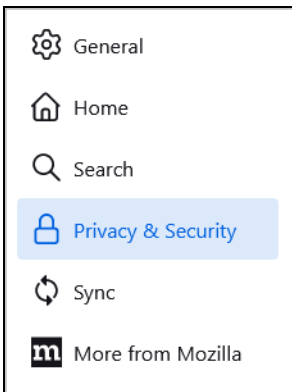

- 3 On the **Privacy & Security** screen, scroll down to locate **Certificates** and click **View Certificates**.

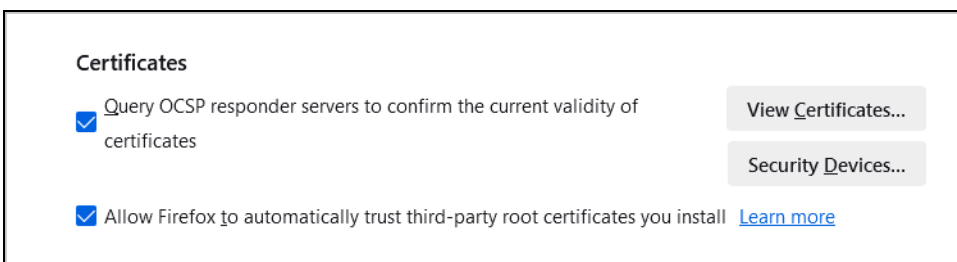

- 4 On the **Certificate Manager** screen, select the **Authorities** tab and click **Import**.

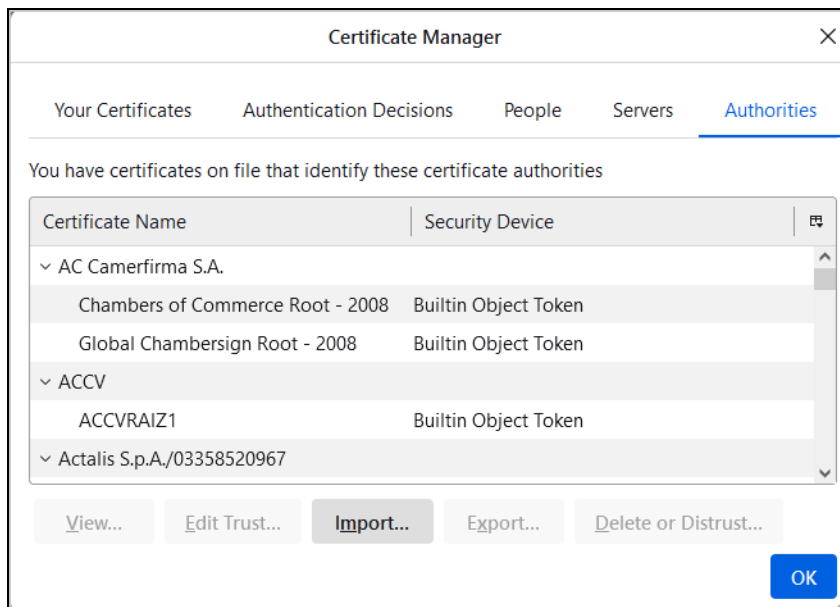

- 5 Open the certificate file in your computer and the **Downloading Certificate** screen appears. Click **Trust this CA to identify websites**. Click **View** to examine the imported CA certificate.

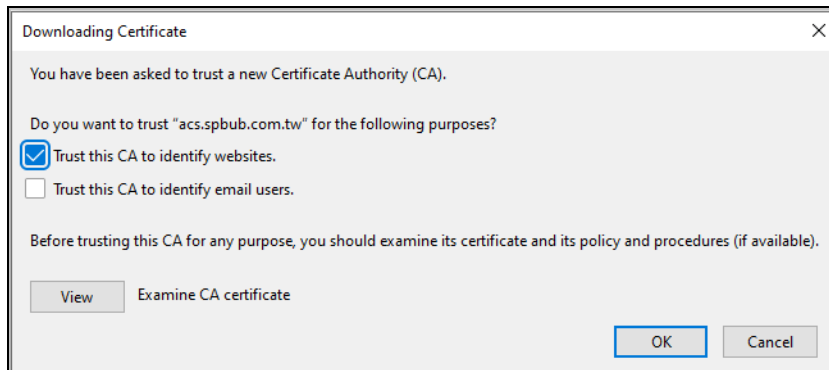

- 6 When the certificate details appear, view the content to confirm the correct organization name. Confirm that the validity period has the correct start and end dates. The **Common Name** can be either an IP address or domain name. Confirm that the client's IP address or domain name aligns with the **Common Name** on the certificate. If all the information on the certificate is correct, close the certificate screen and click **OK**.

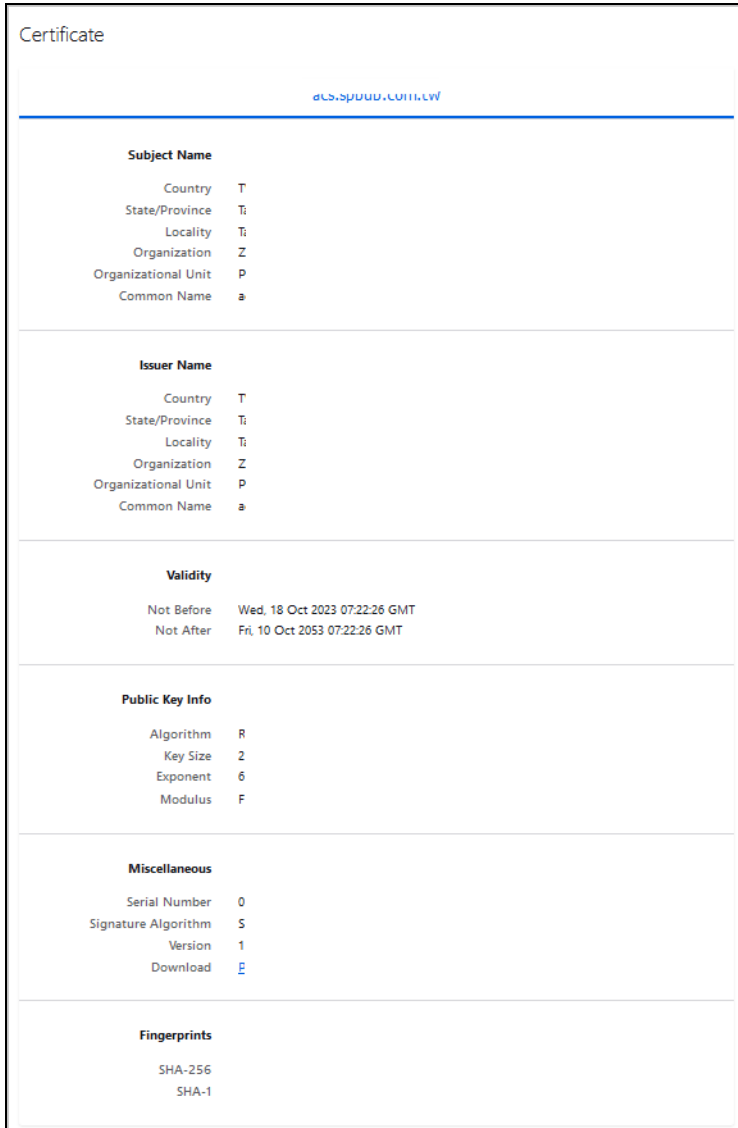

The certificate file is now installed in the Firefox browser.

To check if the import is successful, click **Import** to select the same certificate again to see if the alert **This certificate is already installed as a certificate authority** pops up.

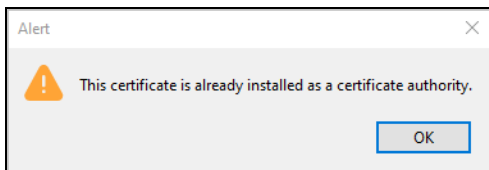

Removing a Certificate in Mozilla Firefox

This section shows you how to remove a public key certificate in Mozilla Firefox.

- 1 Open the Firefox browser and click the **Open application menu** icon on the upper right. Then click **Settings**.

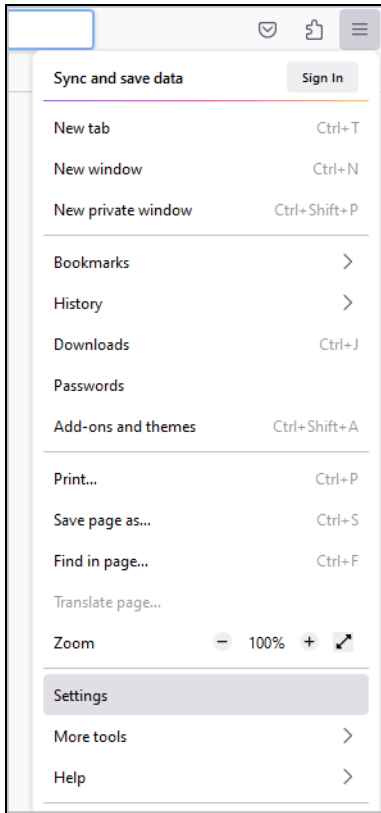

- 2 Click **Privacy & Security**.

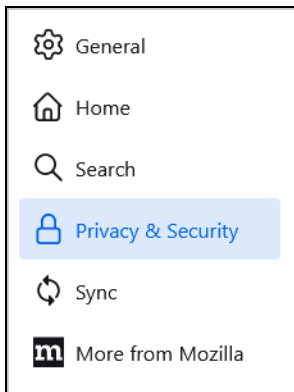

- 3 On the **Privacy & Security** screen, locate **Certificates** and click **View Certificates**.

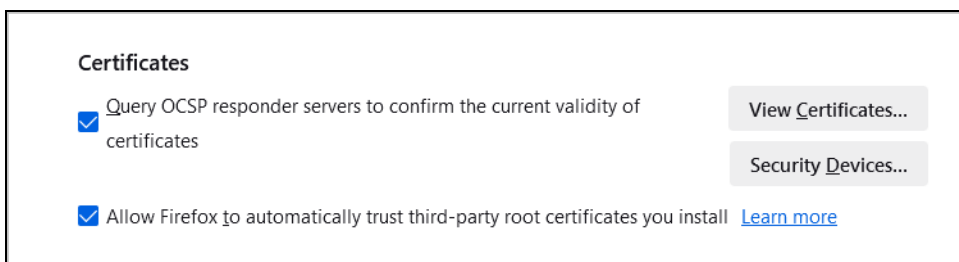

- In the **Certificate Manager** screen, click the **Authorities** tab and select the certificate you want to remove. Then, click **Delete or Distrust**.

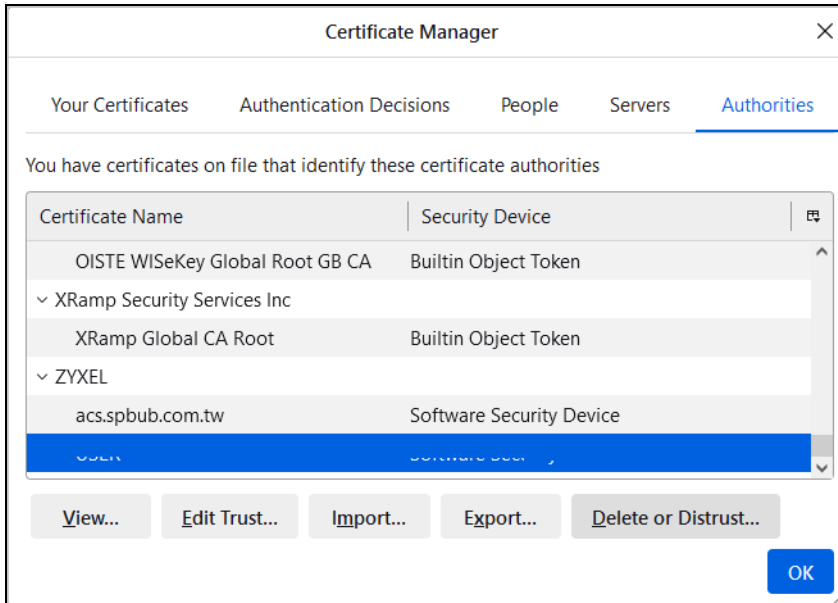

- On the next screen, click **OK**.

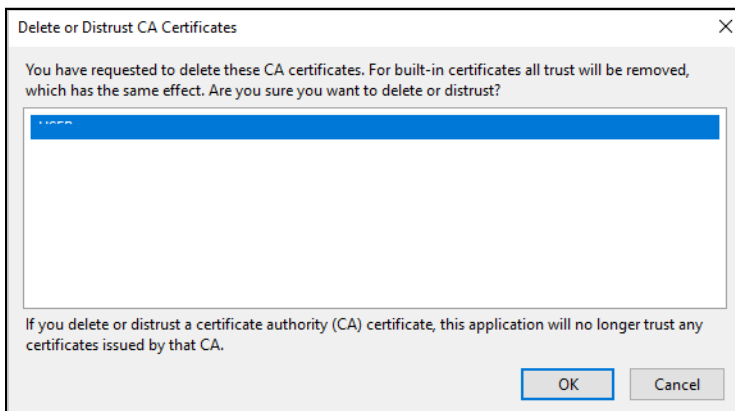

The next time you visit the web site with the public key certificate removed, a certification error will appear.

APPENDIX E

Legal Information

Copyright

Copyright © 2024 by Zyxel and/or its affiliates.

The contents of this publication may not be reproduced in any part or as a whole, transcribed, stored in a retrieval system, translated into any language, or transmitted in any form or by any means, electronic, mechanical, magnetic, optical, chemical, photocopying, manual, or otherwise, without the prior written permission of Zyxel and/or its affiliates.

Published by Zyxel and/or its affiliates. All rights reserved.

Disclaimer

Zyxel does not assume any liability arising out of the application or use of any products, or software described herein. Neither does it convey any license under its patent rights nor the patent rights of others. Zyxel further reserves the right to make changes in any products described herein without notice. This publication is subject to change without notice.

Regulatory Notice and Statement

United States of America



The following information applies if you use the product within USA area.

US Importer: Zyxel Communications, Inc, 1130 North Miller Street Anaheim, CA92806-2001, <https://www.zyxel.com/us/en/>

Federal Communications Commission (FCC) EMC Statement

- This device complies with Part 15 of FCC rules. Operation is subject to the following two conditions:
 - (1) This device may not cause harmful interference.
 - (2) This device must accept any interference received, including interference that may cause undesired operations.
- Changes or modifications not expressly approved by the party responsible for compliance could void the user's authority to operate the equipment.
- This equipment has been tested and found to comply with the limits for a Class A digital device, pursuant to part 15 of the FCC Rules. These limits are designed to provide reasonable protection against harmful interference when the equipment is operated in a commercial environment. This equipment generates, uses, and can radiate radio frequency energy and, if not installed and used in accordance with the instruction manual, may cause harmful interference to radio communications. Operation of this equipment in a residential area is likely to cause harmful interference in which case the user will be required to correct the interference at his own expense.

Canada

The following information applies if you use the product within Canada area.

Innovation, Science and Economic Development Canada ICES statement

CAN ICES-3 (A)/NMB-3(A)

Europe and the United Kingdom



The following information applies if you use the product within the European Union and United Kingdom.

EMC statement

WARNING: This equipment is compliant with Class A of EN55032. In a residential environment this equipment may cause radio interference.

List of National Codes

COUNTRY	ISO 3166 2 LETTER CODE	COUNTRY	ISO 3166 2 LETTER CODE
Austria	AT	Liechtenstein	LI
Belgium	BE	Lithuania	LT
Bulgaria	BG	Luxembourg	LU
Croatia	HR	Malta	MT
Cyprus	CY	Netherlands	NL
Czech Republic	CZ	Norway	NO
Denmark	DK	Poland	PL
Estonia	EE	Portugal	PT
Finland	FI	Romania	RO
France	FR	Serbia	RS
Germany	DE	Slovakia	SK
Greece	GR	Slovenia	SI
Hungary	HU	Spain	ES
Iceland	IS	Sweden	SE
Ireland	IE	Switzerland	CH
Italy	IT	Turkey	TR
Latvia	LV	United Kingdom	GB

Safety Warnings

- To avoid possible eye injury, do NOT look into an operating fiber-optic module's connector.
- Do NOT use this device near water, for example, in a wet basement or near a swimming pool.
- Do NOT expose your device to dampness, dust or corrosive liquids.
- Do NOT store things on the device.
- Do NOT obstruct the device ventilation slots as insufficient airflow may harm your device. For example, do not place the device in an enclosed space such as a box or on a very soft surface such as a bed or sofa.
- Do NOT install or service this device during a thunderstorm. There is a remote risk of electric shock from lightning.
- Connect ONLY suitable accessories to the device.
- Do NOT open the device or unit. Opening or removing covers can expose you to dangerous high voltage points or other risks. Only qualified service personnel should service or disassemble this device. Please contact your vendor for further information.
- Make sure to connect the cables to the correct ports.
- Place connecting cables carefully so that no one will step on them or stumble over them.
- Always disconnect all cables from this device before servicing or disassembling.
- Do NOT remove the plug and connect it to a power outlet by itself; always attach the plug to the power adaptor first before connecting it to a power outlet.
- Do NOT allow anything to rest on the power adaptor or cord and do NOT place the device where anyone can walk on the power adaptor or cord.
- Please use the provided or designated connection cables/power cables/adaptors. Connect it to the right supply voltage (for example, 120V AC in North America or 230V AC in Europe). If the power adaptor or cord is damaged, it might cause electrocution. Remove it from the device and the power source, repairing the power adapter or cord is prohibited. Contact your local vendor to order a new one.
- Do NOT use the device outside, and make sure all the connections are indoors. There is a remote risk of electric shock from lightning.
- CAUTION: RISK OF EXPLOSION IF BATTERY IS REPLACED BY AN INCORRECT TYPE, DISPOSE OF USED BATTERIES ACCORDING TO THE INSTRUCTION. Dispose them at the applicable collection point for the recycling of electrical and electronic device. For detailed information about recycling of this device, please contact your local city office, your household waste disposal service or the store where you purchased the device.
- Use ONLY power wires of the appropriate wire gauge for your device. Connect it to a power supply of the correct voltage.
- Fuse Warning! Replace a fuse only with a fuse of the same type and rating.
- The POE (Power over Ethernet) devices that supply or receive power and their connected Ethernet cables must all be completely indoors.
- The following warning statements apply, where the disconnect device is not incorporated in the device or where the plug on the power supply cord is intended to serve as the disconnect device.
 - For PERMANENTLY CONNECTED DEVICES, a readily accessible disconnect device shall be incorporated external to the device;
 - For PLUGGABLE DEVICES, the socket-outlet shall be installed near the device and shall be easily accessible.
- This device must be grounded by qualified service personnel. Never defeat the ground conductor or operate the device in the absence of a suitably installed ground conductor. Contact the appropriate electrical inspection authority or an electrician if you are uncertain that suitable grounding is available.
- If your device has an earthing screw (frame ground), connect the screw to a ground terminal using an appropriate AWG ground wire. Do this before you make other connections.
- If your device has no earthing screw, but has a 3-prong power plug, make sure to connect the plug to a 3-hole earthed socket.
- When connecting or disconnecting power to hot-pluggable power supplies, if offered with your system, observe the following guidelines:
 - Install the power supply before connecting the power cable to the power supply.
 - Unplug the power cable before removing the power supply.
 - If the system has multiple sources of power, disconnect power from the system by unplugging all power cables from the power supply.
- Do not put the device in a place that is humid, dusty or has extreme temperatures as these conditions may harm your device.
- Please refer to the device back label, datasheet, box specifications or catalog information for the power rating of the device and operating temperature.

- CLASS 1 LASER PRODUCT
- APPAREIL À LASER DE CLASS 1

- PRODUCT COMPLIES WITH 21 CFR 1040.10 AND 1040.11.
- PRODUIT CONFORME SELON 21 CFR 1040.10 ET 1040.11.

Important Safety Instructions

1 Warning! Energy Hazard. Remove all metal jewelry, watches, and so on from your hands and wrists before serving the Switch.

2 Caution! The RJ-45 jacks are not used for telephone line connection.

3  Hazardous Moving Parts. Keep body parts away from fan blades.

4  Hot Surface. Do not touch.

1 Avertissement: Risque de choc électrique. Retirer tout bijoux en métal et votre montre de vos mains et poignets avant de manipuler cet appareil.

2 Attention: Les câbles RJ-45 ne doivent pas être utilisés pour les connections téléphoniques.

3  Mobilité des pièces détachées. S'assurer que les pièces détachées ne sont pas en contact avec les pales du ventilateur.

4  Surface brûlante. Ne pas toucher.

Environment Statement

Disposal and Recycling Information

The symbol below means that according to local regulations your product and/or its battery shall be disposed of separately from domestic waste. If this product is end of life, take it to a recycling station designated by local authorities. At the time of disposal, the separate collection of your product and/or its battery will help save natural resources and ensure that the environment is sustainable development.

Die folgende Symbol bedeutet, dass Ihr Produkt und/oder seine Batterie gemäß den örtlichen Bestimmungen getrennt vom Hausmüll entsorgt werden muss. Wenden Sie sich an eine Recyclingstation, wenn dieses Produkt das Ende seiner Lebensdauer erreicht hat. Zum Zeitpunkt der Entsorgung wird die getrennte Sammlung von Produkt und/oder seiner Batterie dazu beitragen, natürliche Ressourcen zu sparen und die Umwelt und die menschliche Gesundheit zu schützen.

El símbolo de abajo indica que según las regulaciones locales, su producto y/o su batería deberán depositarse como basura separada de la doméstica. Cuando este producto alcance el final de su vida útil, llévelo a un punto limpio. Cuando llegue el momento de desechar el producto, la recogida por separado éste y/o su batería ayudará a salvar los recursos naturales y a proteger la salud humana y medioambiental.

Le symbole ci-dessous signifie que selon les réglementations locales votre produit et/ou sa batterie doivent être éliminés séparément des ordures ménagères. Lorsque ce produit atteint sa fin de vie, amenez-le à un centre de recyclage. Au moment de la mise au rebut, la collecte séparée de votre produit et/ou de sa batterie aidera à économiser les ressources naturelles et protéger l'environnement et la santé humaine.

Il simbolo sotto significa che secondo i regolamenti locali il vostro prodotto e/o batteria deve essere smaltito separatamente dai rifiuti domestici. Quando questo prodotto raggiunge la fine della vita di servizio portarlo a una stazione di riciclaggio. Al momento dello smaltimento, la raccolta separata del vostro prodotto e/o della sua batteria aiuta a risparmiare risorse naturali e a proteggere l'ambiente e la salute umana.

Symbolen innebär att enligt lokal lagstiftning ska produkten och/eller dess batteri kastas separat från hushållsavfallet. När den här produkten når slutet av sin livslängd ska du ta den till en återvinningsstation. Vid tiden för kasseringen bidrar du till en bättre miljö och mänsklig hälsa genom att göra dig av med den på ett återvinningsställe.



台灣

以下訊息僅適用於產品銷售至台灣地區

- 這是甲類的資訊產品，在居住的環境中使用時，可能會造成射頻干擾，在這種情況下，使用者會被要求採取某些適當的對策。
- 為避免電磁干擾，本產品不應安裝或使用於住宅環境。



安全警告 – 為了您的安全，請先閱讀以下警告及指示：

- 請勿將此產品接近水、火焰或放置在高溫的環境。
- 避免設備接觸
 - 任何液體 - 切勿讓設備接觸水、雨水、高濕度、污水腐蝕性的液體或其他水份。
 - 灰塵及污物 - 切勿接觸灰塵、污物、沙土、食物或其他不合適的材料。
- 雷雨天氣時，不要安裝或維修此設備。有遭受電擊的風險。
- 切勿重摔或撞擊設備，並勿使用不正確的電源變壓器。
- 若接上不正確的電源變壓器會有爆炸的風險。
- 請勿隨意更換產品內的電池。
- 如果更換不正確之電池型式，會有爆炸的風險，請依製造商說明書處理使用過之電池。
- 請將廢電池丟棄在適當的電器或電子設備回收處。
- 請勿將設備解體。
- 請勿阻礙設備的散熱孔，空氣對流不足將會造成設備損害。
- 請使用隨貨提供或指定的連接線 / 電源線 / 電源變壓器，將其連接到合適的供應電壓 (如：台灣供應電壓 110 伏特)。
- 假若電源變壓器或電源變壓器的纜線損壞，請從插座拔除，若您還繼續插電使用，會有觸電死亡的風險。
- 請勿試圖修理電源變壓器或電源變壓器的纜線，若有毀損，請直接聯絡您購買的店家，購買一個新的電源變壓器。
- 請勿將此設備安裝於室外，此設備僅適合放置於室內。
- 請勿隨一般垃圾丟棄。
- 請參閱產品背貼上的設備額定功率。
- 請參考產品型錄或是彩盒上的作業溫度。
- 設備必須接地，接地導線不允許被破壞或沒有適當安裝接地導線，如果不確定接地方式是否符合要求可聯繫相應的電氣檢驗機構檢驗。
- 如果您提供的系統中有提供熱插拔電源，連接或斷開電源請遵循以下指導原則：
 - 先連接電源線至設備連，再連接電源。
 - 先斷開電源再拔除連接至設備的電源線。
 - 如果系統有多個電源，需拔除所有連接至電源的電源線再關閉設備電源。
- 產品沒有斷電裝置或者採用電源線的插頭視為斷電裝置的一部分，以下警語將適用：
 - 對永久連接之設備，在設備外部須安裝可觸及之斷電裝置；
 - 對插接式之設備，插座必須接近安裝之地點而且是易於觸及的。

About the Symbols

Various symbols are used in this product to ensure correct usage, to prevent danger to the user and others, and to prevent property damage. The meaning of these symbols are described below. It is important that you read these descriptions thoroughly and fully understand the contents.

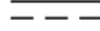
Explanation of the Symbols

SYMBOL	EXPLANATION
	Alternating current (AC): AC is an electric current in which the flow of electric charge periodically reverses direction.
	Direct current (DC): DC is the unidirectional flow or movement of electric charge carriers.
	Earth; ground: A wiring terminal intended for connection of a Protective Earthing Conductor.
	Class II equipment: The method of protection against electric shock in the case of class II equipment is either double insulation or reinforced insulation.

Viewing Certifications

Go to <https://www.zyxel.com> to view this product's documentation and certifications.

Zyxel Limited Warranty

Zyxel warrants to the original end user (purchaser) that this product is free from any defects in material or workmanship for a specific period (the Warranty Period) from the date of purchase. The Warranty Period varies by region. Check with your vendor and/or the authorized Zyxel local distributor for details about the Warranty Period of this product. During the warranty period, and upon proof of purchase, should the product have indications of failure due to faulty workmanship and/or materials, Zyxel will, at its discretion, repair or replace the defective products or components without charge for either parts or labor, and to whatever extent it shall deem necessary to restore the product or components to proper operating condition. Any replacement will consist of a new or re-manufactured functionally equivalent product of equal or higher value, and will be solely at the discretion of Zyxel. This warranty shall not apply if the product has been modified, misused, tampered with, damaged by an act of God, or subjected to abnormal working conditions.

Note

Repair or replacement, as provided under this warranty, is the exclusive remedy of the purchaser. This warranty is in lieu of all other warranties, express or implied, including any implied warranty of merchantability or fitness for a particular use or purpose. Zyxel shall in no event be held liable for indirect or consequential damages of any kind to the purchaser.

To obtain the services of this warranty, contact your vendor. You may also refer to the warranty policy for the region in which you bought the device at <https://www.zyxel.com/global/en/support/warranty-information>.

Registration

Register your product online at www.zyxel.com to receive email notices of firmware upgrades and related information.

Trademarks

The trademarks mentioned in this publication are used for identification purposes only and may be properties of their respective owners.

Index

Numbers

802.1P priority [214, 400](#)

A

AAA [295](#)

- accounting [295](#)
- authentication [295](#)
- authorization [295](#)
- external server [295](#)
- RADIUS [295](#)

AAA (Authentication, Authorization and Accounting) [295](#)

access control

- account security [308](#)
- limitations [304, 409](#)
- login account [146, 380](#)
- overview [304](#)
- remote management [306, 307, 410, 412](#)
- service port [304, 409](#)
- SNMP [154](#)

account security [308](#)

Account Security screen [308](#)

accounting

- setup [298](#)

Address Resolution Protocol (ARP) [96, 277, 350, 351](#)

admin [308](#)

administrator password [147, 381](#)

AES (Advanced Encryption Standard) [384](#)

aging time [161](#)

air circulation

- for cooling [32](#)

All connected

- Setting Wizard [275](#)

applications

- backbone [28](#)
- bridging [29](#)
- fiber uplink [29](#)
- IEEE 802.1Q VLAN [30](#)

PoE [27](#)

switched workgroup [29](#)

ARP

- how it works [277](#)
- learning mode [277](#)
- overview [277](#)

ARP (Address Resolution Protocol) [96](#)

ARP Learning screen [279](#)

ARP Setup screen [279](#)

ARP Table screen [96](#)

ARP-Reply [277](#)

ARP-Request [278](#)

ATM (Asynchronous Transmission Mode) [29](#)

authentication

- setup [298](#)

authentication, authorization and accounting [295](#)

authorization

- privilege levels [300, 301](#)
- setup [298](#)

authorized technician

- install the Switch [32](#)

auto PD recovery [169](#)

- enable [169, 388](#)
- quick link [372](#)
- restart [169](#)
- use LLDP or ping [169, 388](#)

auto-crossover port [40](#)

auto-fan [22](#)

automatic PD recovery

- create [171](#)

automatic VLAN registration [259](#)

auto-MDIX port [40](#)

B

back up

- configuration file [348, 416](#)

Backup Configuration screen [415, 416](#)

bandwidth control [242, 243](#)

egress rate [243](#)
 ingress rate [243](#)
 setup [242](#)
 Bandwidth Control screen [242](#)
 basic setup tutorial [86](#)
 binding table
 build [323](#)
 BPDUs [245](#)
 Bridge Protocol Data Units (BPDUs) [245](#)
 broadcast storm control [315](#)
 Wizard [65](#)

C

cables
 supported [27](#)
 Certificates screen [339](#)
 certifications
 viewing [461](#)
 CFI (Canonical Format Indicator) [258](#)
 changing the password [78](#)
 Class of Service [233](#)
 clearance
 Switch installation [32](#)
 cloning a port, see port cloning
 Cloud Connection Status [92](#)
 cloud management [375](#)
 Cloud Management screen [375](#)
 cluster management [342](#)
 and switch passwords [346](#)
 cluster manager [342](#), [345](#)
 cluster member [342](#)
 cluster member firmware upgrade [347](#)
 network example [342](#)
 setup [344](#)
 specification [342](#)
 status [343](#)
 switch models [342](#)
 VID [345](#)
 Web Configurator [346](#)
 Cluster Management Configuration screen [344](#)
 cluster manager [342](#)
 CNC
 portal [425](#)
 combo port [42](#)

Config 1 [357](#)
 Config 2 [357](#)
 configuration
 back up [31](#)
 change running config [356](#), [418](#)
 save [417](#)
 saving [78](#)
 configuration file
 backup [348](#), [416](#)
 restore [348](#), [415](#)
 save [350](#), [417](#)
 Configure Clone screen [350](#)
 contact information [428](#)
 copying port settings, see port cloning
 copyright [457](#)
 CoS [233](#)
 CPU management port [272](#)
 CPU protection [317](#)
 crossover Ethernet cable [39](#)
 current date [122](#), [378](#)
 current time [122](#), [378](#)
 Custom Default [357](#)
 custom default
 restore [79](#)
 customer support [428](#)

D

date
 current [122](#)
 daylight saving time [122](#), [378](#)
 DDMI Details screen [113](#)
 DDMI screen [112](#)
 debug port [42](#)
 DES (Data Encryption Standard) [384](#)
 device back label
 Switch [24](#)
 DHCP
 configuration options [281](#)
 Dynamic Host Configuration Protocol [281](#)
 modes [281](#)
 Relay Agent Information format [283](#)
 DHCP Option 82 Profile screen [283](#), [284](#)
 DHCP relay

- configure [88](#)
 - tutorial [86](#)
 - DHCP relay agent [439](#)
 - DHCP relay option 82 [333](#)
 - DHCP server
 - block [323](#)
 - DHCP snooping [323, 332](#)
 - configure [333](#)
 - DHCP relay option 82 [333](#)
 - trusted ports [332](#)
 - untrusted ports [332](#)
 - DHCP snooping database [333](#)
 - DHCP Status screen [282](#)
 - DHCP Unique IDentifier (DUID) [438](#)
 - DHCPv4
 - global relay [285](#)
 - global relay example [287](#)
 - Option 82 [282](#)
 - option 82 profiles [283, 284](#)
 - Relay Agent Information [282](#)
 - DHCPv4 relay [282](#)
 - DHCPv6
 - enable in Windows 10 [442](#)
 - DHCPv6 Client Setup screen [144](#)
 - DHCPv6 relay [292](#)
 - interface-ID [292](#)
 - remote-ID [292](#)
 - DHCPv6 Relay screen [292, 293](#)
 - diagnostics
 - ping [353](#)
 - Differentiated Service (DiffServ) [233](#)
 - DiffServ [233](#)
 - activate [234](#)
 - DS field [233](#)
 - DSCP [233](#)
 - network example [234](#)
 - PHB [233](#)
 - service level [233](#)
 - DiffServ Code Points [233](#)
 - Digital Diagnostics Monitoring Interface [112](#)
 - disclaimer [457](#)
 - disposal and recycling information
 - EU [459](#)
 - DS (Differentiated Services) [233](#)
 - DSCP [233](#)
 - what it does [233](#)
 - dual firmware images [355, 417](#)
 - dual personality interface [42, 48](#)
 - duplex mode [39](#)
 - dust plug [41](#)
 - Dynamic Host Configuration Protocol for IPv6 (DHCPv6) [438](#)
 - dynamic link aggregation [176](#)
- ## E
- egress port [275](#)
 - egress rate [243](#)
 - electrical inspection authority [45](#)
 - electrician [45](#)
 - electrostatic discharge (ESD) [40](#)
 - EMC statement [457](#)
 - Environment Statement [459](#)
 - Errdisable Detect screen [320](#)
 - Errdisable Recovery screen [321](#)
 - errdisable status [319](#)
 - error disable [317](#)
 - control packets [318](#)
 - CPU protection [319](#)
 - detect [320](#)
 - recovery [321](#)
 - status [318](#)
 - error-disable recovery [317](#)
 - Ethernet broadcast address [96, 277](#)
 - Ethernet MAC [116, 374](#)
 - Ethernet port
 - auto-crossover [39](#)
 - auto-negotiating [39](#)
 - dual personality [39](#)
 - Ethernet ports
 - number of [22](#)
 - Ethernet settings
 - default [39](#)
 - external authentication server [296](#)
- ## F
- Factory Default [357](#)
 - FCC interference statement [457](#)

fiber cable
 connecting [41](#)
 removal [42](#)
 file transfer using FTP
 command example [341](#)
 filename convention, configuration
 file names [340](#)
 filtering [252](#)
 rules [252](#)
 filtering database, MAC table [100](#)
 Filtering screen [252](#)
 firmware [373](#)
 upgrade [347](#), [355](#), [417](#)
 ZyNOS [115](#)
 firmware upgrade [417](#)
 Firmware Upgrade screen [355](#)
 flow control
 back pressure [214](#), [400](#)
 IEEE802.3x [214](#), [400](#)
 frames
 tagged [265](#), [408](#)
 untagged [265](#), [408](#)
 freestanding installation
 precautions [33](#)
 front panel [38](#)
 FTP [340](#)
 file transfer procedure [341](#)
 restrictions over WAN [342](#)
 full duplex
 Ethernet port [39](#)

G

GARP (Generic Attribute Registration Protocol) [260](#)
 GARP timer [260](#)
 GbE combo ports
 number of [22](#)
 general setup [121](#)
 General Setup screen [121](#), [377](#)
 getting help [80](#)
 gigabit ports [39](#)
 GMT (Greenwich Mean Time) [122](#), [378](#)
 gratuitous ARP [278](#)
 green Ethernet [174](#)

 and uplink port [174](#)
 auto power down [174](#)
 EEE [174](#)
 short reach [174](#)
 grounding
 for safety [43](#)
 GS1350 Series
 comparison table [22](#)
 models [22](#)
 Web Configurator comparison table [25](#)
 GVRP [260](#)
 GVRP (GARP VLAN Registration Protocol) [260](#)

H

half duplex
 Ethernet port [39](#)
 hardware features [22](#)
 hardware installation [32](#)
 hardware monitor [116](#), [374](#)
 hardware overview [38](#)
 HTTPS [311](#)
 certificates [311](#)
 implementation [311](#)
 public keys, private keys [311](#)
 HTTPS Certificates screen [340](#)
 HTTPS example [312](#)

I

IANA (Internet Assigned Number Authority) [433](#)
 Identity Association (IA) [438](#)
 IEEE 802.3af [26](#)
 IEEE 802.3at [26](#)
 IEEE 802.3az [174](#)
 IEEE 802.3bt [26](#)
 IEEE standard [27](#)
 IGMP filtering
 profiles [223](#)
 IGMP leave timeout
 fast [225](#)
 IGMP snooping [221](#)
 IGMP snooping and VLANs [222](#)

- ingress port [275](#)
 - ingress rate [243](#)
 - initial setup [81](#)
 - Innovation, Science and Economic Development
Canada ICES statement [457](#)
 - installation
 - air circulation [32](#)
 - desktop [32](#)
 - freestanding [32](#)
 - rack-mounting [35](#)
 - transceiver [40](#)
 - wall mounting [33](#)
 - installation requirements
 - wall mounting [33](#)
 - installation scenarios [32](#)
 - Interface Setup screen [124, 125](#)
 - Internet Protocol version 6, see IPv6
 - IP
 - configuration [129](#)
 - interface [126](#)
 - routing domain [126](#)
 - status [127](#)
 - IP address [128](#)
 - Switch management [83](#)
 - IP Address Information [372](#)
 - IP Setup
 - quick link [372](#)
 - IP setup [378](#)
 - IP Setup screen [126, 378](#)
 - IP Status Detail screen [127](#)
 - IP subnet mask [128](#)
 - IPv6 [436](#)
 - addressing [436](#)
 - enable in Windows 10 [442](#)
 - enable in Windows 7 [441](#)
 - EUI-64 [438](#)
 - global address [436](#)
 - interface ID [438](#)
 - link-local address [436](#)
 - Neighbor Discovery Protocol [436](#)
 - neighbor table [98](#)
 - ping [436](#)
 - prefix [436](#)
 - prefix length [436](#)
 - unspecified address [437](#)
 - IPv6 cache [440](#)
 - IPv6 Global Setup screen [136](#)
 - IPv6 interface [124](#)
 - DHCPv6 client [144](#)
 - enable [137](#)
 - global address [139, 140](#)
 - global unicast address [135](#)
 - link-local address [138](#)
 - link-local IP [135](#)
 - neighbor discovery [141](#)
 - neighbor table [142](#)
 - status [134](#)
 - IPv6 Interface Setup Edit screen [137](#)
 - IPv6 Interface Setup screen [137](#)
 - IPv6 Interface Status screen [134](#)
 - IPv6 Neighbor Setup screen [142, 143](#)
 - IPv6 Neighbor Table screen [98](#)
 - IPv6 screen [133](#)
- ## J
- Java permission [50, 423](#)
 - JavaScript [50, 423](#)
- ## L
- LACP [176](#)
 - system priority [181, 394](#)
 - timeout [182, 395](#)
 - Layer Link Discovery Protocol (LLDP) [369](#)
 - LED behavior
 - CLOUD [23](#)
 - LED description [23, 46](#)
 - LEDs [46](#)
 - limit MAC address learning [337](#)
 - link aggregation [64, 176](#)
 - dynamic [176](#)
 - ID information [177](#)
 - setup [179, 392](#)
 - traffic distribution algorithm [178, 391](#)
 - traffic distribution type [180, 393](#)
 - trunk group [176](#)
 - link aggregation (trunking) [392](#)
 - example [29](#)
 - Link Aggregation Control Protocol (LACP) [176](#)
 - Link Aggregation Control Protocol screen [393](#)

Link Aggregation screen
 Wizard **63**
 Link Aggregation Setting screen **392**
 Link Aggregation Status screen **390**
 Link Layer Discovery Protocol **184**
 LLDP **184**
 basic TLV **198**
 global settings **196**
 local port status **188**
 organization-specific TLV **199**
 status of remote device **191**
 TLV **184**
 LLDP (Link Layer Discovery Protocol) **184**
 LLDP-MED **185**
 classes of endpoint devices **185**
 example **185**
 LLDP-MED Location screen **202**
 LLDP-MED Setup screen **200**
 logout **79**
 Switch **79**
 log message **117**
 login **50**
 password **78**
 privilege level **147**
 login account
 administrator **146, 380**
 non-administrator **146, 380**
 login accounts **146, 380**
 configuring through Web Configurator **146, 380**
 multiple **146, 380**
 number of **146, 380**
 login password **381**
 edit **147**
 login user name
 display **308**
 Logins screen **146, 380**
 loop guard **216, 401**
 examples **217**
 port shut down **217**
 setup **218, 401**
 vs. STP **216, 401**
 Wizard **65**
 Loop Guard screen **401**

M

MAC (Media Access Control) **116, 374**
 MAC address **96, 116, 374**
 maximum number per port **337**
 MAC address learning **161, 337**
 specify limit **337**
 MAC Based VLAN screen **268, 269**
 MAC freeze **336**
 MAC table **100**
 display criteria **102**
 how it works **100**
 sorting criteria **102**
 viewing **101**
 MAC-based VLAN **268**
 maintenance
 configuration backup **348, 416**
 firmware **355, 417**
 restore configuration **348, 415**
 Management Information Base (MIB) **154**
 management IP address **83**
 management mode **22**
 management port **275**
 managing the device
 using the command line interface, see command line interface **31**
 managing the Switch
 cluster management **31**
 good habits **31**
 NCC **30**
 using FTP, see FTP **31**
 using SNMP **31**
 Web Configurator **31**
 ZON Utility **31**
 maximum transmission unit **107**
 Maximum Transmission Unit (MTU) **134**
 Mbuf (Memory Buffer) **365, 419**
 MD5 (Message Digest 5) **384**
 MDIX (Media Dependent Interface Crossover) **40**
 Media Access Control **116, 374**
 Memory Buffer **365**
 MIB
 and SNMP **154**
 supported MIBs **155**
 MIB (Management Information Base) **154**
 mirroring ports **219**

monitor port [219](#)
 mounting brackets
 attaching [36](#)
 MTU [107](#)
 MTU (Multi-Tenant Unit) [160](#)
 multicast
 802.1 priority [223](#)
 IP addresses [221](#)
 setup [223](#)
 multicast IP address [228](#)
 multicast MAC address [228](#)
 Multi-Tenant Unit [160](#)
 myZyxel account
 sign up [24](#)
 myZyxel account information
 enter [24](#)

N

Nebula Cloud Management [23](#)
 switching to [23](#)
 Nebula web portal [23](#)
 access in three ways [23](#)
 Neighbor Detail screen [369](#)
 Neighbor Details [105](#)
 Neighbor Discovery Protocol (NDP) [439](#)
 Neighbor screen [103](#)
 network applications [27](#)
 network element (NE) [381](#)
 network management system (NMS) [154, 381](#)
 NTP (RFC-1305) [122, 377](#)

O

one-time schedule [165](#)
 ONVIF [402](#)
 enable [231](#)
 quick link [372](#)
 ONVIF protocol [231, 402](#)
 ONVIF screen [402](#)
 Option 82 [282](#)
 organization

 create [24](#)
 Organizationally Unique Identifiers (OUI) [266](#)
 Org-specific TLV Setting screen [199](#)
 overheating
 prevention [32](#)

P

password [78](#)
 administrator [147, 381](#)
 change [31](#)
 change through Wizard [62](#)
 display [308](#)
 write down [31](#)
 password encryption
 activate [309](#)
 Path MTU Discovery [107](#)
 Path MTU Table screen [107](#)
 Per-Hop Behavior [233](#)
 PHB [233](#)
 ping, test connection [353](#)
 PoE
 PD priority [210, 398](#)
 power management mode [209, 397](#)
 power-up mode [208, 388, 397](#)
 PoE (Power over Ethernet) [206](#)
 PoE features
 by model [26](#)
 PoE ports
 number of [22](#)
 PoE Setup
 quick link [372](#)
 PoE Setup screen [208](#)
 PoE standards [26](#)
 PoE Status screen [207](#)
 PoE Time Range Setup screen [211, 212](#)
 PoE type [27](#)
 port
 maximum power [27](#)
 setup [213](#)
 speed/duplex [214](#)
 voltage range [27](#)
 port cloning [350, 351](#)
 advanced settings [350, 351](#)
 basic settings [350, 351](#)

port details [109](#)
port isolation
 Setting Wizard [275](#)
port mirroring [219](#)
port redundancy [176](#)
Port screen
 DHCPv4 Global Relay [286](#)
 SNMP traps [386](#)
port security [335](#)
 address learning [337](#)
 limit MAC address learning [337](#)
 setup [335](#)
port setup [399](#)
 quick link [372](#)
Port Setup screen [213, 399](#)
port status
 port details [109](#)
 port utilization [114](#)
port utilization [114](#)
Port VID (PVID) [82](#)
port VLAN ID, see PVID [265, 408](#)
port VLAN trunking [258](#)
port-based VLAN [271](#)
 all connected [275](#)
 configure [272](#)
 port isolation [275](#)
 settings wizard [275](#)
ports
 diagnostics [354](#)
 mirroring [219](#)
 speed/duplex [399](#)
 standby [177](#)
power
 maximum per port [27](#)
Power Budget
 PoE [27](#)
power connection [45](#)
power connections [45](#)
power connector [45](#)
power management mode
 PoE [27](#)
power module
 disconnecting [46](#)
Power Sourcing Equipment (PSE) [26](#)
powered device (PD) [26, 206](#)
prefix delegation [439](#)

product registration [461](#)
PVID [258](#)

Q

QoS [233](#)
 priority setting [70](#)
QoS setting [69](#)
QR code
 Switch [24](#)
 where to find [24](#)
Quality of Service [233](#)
queue weight [238](#)
queuing [237, 238](#)
 SPQ [237](#)
 WRR [237](#)
queuing method [237, 239](#)
Quick Setup screen [372](#)
Quick Start Guide
 steps for registering the Switch [23](#)

R

rack-mount [22](#)
rack-mounting [35](#)
 installation requirements [35](#)
 precautions [36](#)
RADIUS [296, 304](#)
 advantages [296](#)
 and tunnel protocol attribute [302](#)
 setup [296](#)
Rapid Spanning Tree Protocol (RSTP) [244](#)
Read Only Memory (ROM) [419](#)
rear panel [43](#)
reboot
 load configuration [356, 418](#)
reboot system [356, 418](#)
Reboot System screen [418](#)
recurring schedule [165](#)
registration
 product [461](#)
Registration MAC address [24](#)
Regulatory Notice and Statement [457](#)

remote management **306, 307, 410, 412**
 service **307, 308, 411, 413**
 trusted computers **306, 308, 411, 412**

RESET button **80**

resetting **79, 349**
 to factory default settings **349**

restore
 configuration **31**
 configuration file **415**

RESTORE button **79**

restore configuration **79, 348**

RFC 3164 **162**

Round Robin Scheduling **237**

Router Advertisement (RA) **439**

routing domain **126**

RSTP
 configuration **250**

rubber feet
 attach **33**

running configuration **349**
 erase **349**
 reset **349**

S

safety precautions
 using the Switch **32**

safety warnings **458**

save configuration **78, 350, 417**

Save Configuration screen **416**

Save link **79**

schedule
 one-time **165**
 recurring **165**
 type **166**

screw anchors
 using **34**

Secure Shell, see SSH

serial number
 Switch **24**

service access control **304, 409**
 service port **305, 410**

Service Access Control screen **409**

Setup Wizard

parts **60**

Setup Wizard screen **54**

SFP interface
 number of **22**

SFP/SFP+ slot **40**

SHA (Secure Hash Algorithm) **384**

Simple Network Management Protocol (SNMP) **381**

Simple Network Management Protocol, see SNMP

site
 create **24**

Small Form-factor Pluggable (SFP) **40**

SNMP **154**
 agent **154**
 and MIB **154**
 authentication **150, 151, 383, 384**
 communities **149, 382**
 management model **154**
 manager **154**
 MIB **155**
 network components **154**
 object variables **154**
 protocol operations **154**
 security **151, 383, 384**
 security level **150**
 settings **381**
 setup **148, 381**
 traps **152, 385**
 users **150, 383**
 version 3 and security **154**
 versions supported **154, 381**

SNMP agent
 enable through Wizard **62**

SNMP screen **381**

SNMP Trap Group screen **385**

SNMP traps **155**
 supported **155, 158**

SNMP User screen **383**

SNMP version
 select **63**

Spanning Tree Protocol (RSTP) **401**

SPQ (Strict Priority Queuing) **237**

SSH
 encryption methods **311**
 how it works **310**
 implementation **311**

SSH (Secure Shell) **310**

SSH Authorized Keys screen **358**

SSL (Secure Socket Layer) **311**
Standalone mode
 switch to **26**
standby ports **177**
static MAC address **254**
static MAC forwarding **254**
Static MAC Forwarding screen **254, 255**
static multicast forwarding **228**
static VLAN **262, 405**
 control **264, 407**
 tagging **264, 407**
Static VLAN screen **405**
status **70, 367**
 STP **248**
 VLAN **260, 403**
STP
 bridge ID **249**
 bridge priority **250**
 designated bridge **245**
 edge port **251**
 forwarding delay **251**
 Hello BPDU **245**
 Hello Time **249, 250**
 how it works **245**
 Max Age **249, 250**
 path cost **244, 251**
 port priority **251**
 port role **249**
 port state **245, 249**
 root port **245**
 status **248**
 terminology **244**
 vs. loop guard **216, 401**
STP Path Cost **245**
straight-through Ethernet cable **39**
subnet masking **438**
Summary screen **367**
Surveillance mode **26, 367**
 overview **367**
Switch
 DHCP client **50**
 fanless-type usage precaution **32**
 fan-type usage precaution **32**
switch lockout **79**
Switch reset **79**
syslog **162**
 protocol **162**

 settings **162**
 setup **162**
 severity levels **162**
Syslog Setup screen **162**
System Info screen **115, 373**
system information **373**
system reboot **356, 418**

T

tag-based VLAN
 example **30**
tagged VLAN **257**
Tech-Support **364, 419**
 log enhancement **364, 419**
Tech-Support screen **364**
temperature indicator **116, 374**
terminal emulation software
 parameters **43**
time
 current **122, 378**
 daylight saving **122**
 format **122**
Time (RFC-868) **122, 377**
time range **165**
time server **122, 377**
time service protocol **122, 377**
 format **377**
ToS **233**
trademarks **461**
transceiver
 connection interface **40**
 connection speed **40**
 installation **40**
 removal **41**
transceiver MultiSource Agreement (MSA) **40**
transceivers **40**
traps
 destination **149, 382**
troubleshooting **89**
trunk group **176**
Trunk Tagged port **69**
trunking **176**
trusted ports

DHCP snooping [332](#)
 tunnel protocol attribute
 and RADIUS [302](#)
 tutorial
 basic setup [86](#)
 twisted pair
 used [27](#)
 Type of Service [233](#)
 Type Transfer [102](#)

U

unregister
 Switch [26](#)
 untrusted ports
 DHCP snooping [332](#)
 uplink connection [42](#)
 super-fast [29](#)
 user name [53](#)
 default [53](#)
 user profiles [296](#)
 UTC (Universal Time Coordinated) [122](#)

V

Vendor ID Based VLAN screen [270](#)
 Vendor Specific Attribute, see VSA [301](#)
 ventilation holes [32](#)
 VID [130](#), [131](#), [261](#), [262](#), [379](#), [404](#), [405](#)
 number of possible VIDs [258](#)
 priority frame [258](#)
 VID (VLAN Identifier) [258](#)
 View-based Access Control Model (VACM) [384](#)
 Virtual Local Area Network [160](#)
 VLAN [160](#)
 acceptable frame type [265](#), [408](#)
 and IGMP snooping [222](#)
 automatic registration [259](#)
 creation [81](#), [86](#)
 ID [257](#)
 ingress filtering [265](#), [408](#)
 introduction [160](#), [257](#)
 number of VLANs [261](#), [404](#)

 port number [262](#), [405](#)
 port settings [264](#), [407](#)
 port-based [275](#)
 port-based VLAN [271](#)
 port-based, isolation [275](#)
 port-based, wizard [275](#)
 PVID [265](#), [408](#)
 static VLAN [262](#), [405](#)
 status [260](#), [261](#), [262](#), [403](#), [404](#), [405](#)
 tagged [257](#)
 terminology [260](#)
 trunking [258](#), [266](#), [408](#)
 type [161](#), [259](#)
 VLAN (Virtual Local Area Network) [160](#)
 VLAN Detail screen [404](#)
 VLAN ID [257](#)
 VLAN member port [69](#)
 VLAN number [128](#), [130](#), [131](#), [379](#)
 VLAN Port Setting screen [407](#)
 VLAN setting
 Wizard [68](#)
 VLAN Setting screen
 DHCPv4 [290](#)
 VLAN Status screen [403](#)
 VLAN terminology [260](#)
 VLAN trunking [266](#), [408](#)
 VLAN-unaware devices [82](#)
 voice VLAN [266](#)
 Voice VLAN Setup screen [266](#), [267](#)
 voltage range
 port [27](#)
 VSA [301](#)

W

wall mounting [33](#)
 distance above the floor [33](#)
 distance between holes [33](#)
 wall-mount [22](#)
 warranty
 note [461](#)
 Web browser pop-up window [50](#), [423](#)
 Web Configurator
 getting help [80](#)
 home [70](#)

- login [50](#)
- logout [80](#)
- navigating components [71](#)
- navigation panel [73](#)
- online help [80](#)
- usage prerequisite [50](#)

weight [238](#)

WRR (Weighted Round Robin Scheduling) [237](#)

Z

ZDP [56](#)

ZON Utility [56](#)

- compatible OS [56](#)
- fields description [59](#)
- icon description [58](#)
- installation requirements [56](#)
- introduction [26](#)
- minimum hardware requirements [57](#)
- network adapter select [57](#)
- password prompt [58](#)
- run [57](#)
- supported firmware version [59](#)
- supported models [59](#)
- Switch IP address [50](#)

ZON utility

- use for troubleshooting [423](#)

ZyNOS (Zyxel Network Operating System) [340](#)

Zyxel AP Configurator (ZAC) [59](#)

Zyxel Discovery Protocol (ZDP) [56](#)

Zyxel Nebula Mobile app [24](#)

Zyxel One Network (ZON) Utility [26](#)